

Manual do Proprietário
LS460I



©2007 TOYOTA MOTOR CORPORATION

All rights reserved. This material may not be reproduced or copied, in whole or in part, without the written permission of Toyota Motor Corporation.

TABLE OF CONTENTS

1	Before driving	Adjusting and operating features such as door locks, mirrors, and steering column.
2	When driving	Driving, stopping and safe-driving information.
3	Interior features	Air conditioning and audio systems, as well as other interior features for a comfortable driving experience.
4	Maintenance and care	Cleaning and protecting your vehicle, performing do-it-yourself maintenance, and maintenance information.
5	When trouble arises	What to do if the vehicle needs to be towed, gets a flat tire, or is involved in an accident.
6	Vehicle specifications	Detailed vehicle information.
	Index	Alphabetical listing of information contained in this manual.

1 Before driving

1-1. Key information.....	28	Power windows	89
Keys	28	Moon roof	91
1-2. Opening, closing and locking the doors and trunk.....	33	1-5. Refueling.....	94
Smart entry & start system	33	Opening the fuel tank cap.....	94
Wireless remote control.....	47	1-6. Theft deterrent system	97
Doors	49	Engine immobilizer system.....	97
Trunk	54	Alarm	99
1-3. Adjustable components (seats, mirrors, steering wheel).....	59	1-7. Safety information.....	101
Front seats.....	59	Correct driving posture	101
Power rear seat (5-seat models)	63	SRS airbags	103
Power rear seat (4-seat models).....	66	Child restraint systems	115
Driving position memory	70	Installing child restraints.....	119
Rear seat position memory	74		
Head restraint.....	76		
Seat belts	78		
Steering wheel	84		
Anti-glare inside rear view mirror	86		
Outside rear view mirrors.....	87		
1-4. Opening and closing the windows and moon roof.....	89		

2 When driving

2-1. Driving procedures	128
Driving the vehicle.....	128
Engine (ignition) switch	135
Automatic Transmission	139
Turn signal lever	143
Parking brake	144
Brake Hold.....	147
2-2. Instrument cluster	149
Gauges and meters	149
Indicators and warning lights ...	152
Multi-information display.....	155

2-3. Operating the lights and windshield wipers	159
Headlight switch.....	159
Fog light switch	162
Windshield wipers and washer.....	163
Headlight cleaner switch.....	166
2-4. Using other driving systems	167
Cruise control	167
Lexus parking assist-sensor.....	171
Rear view monitor system.....	179
Driving assist systems.....	182
2-5. Driving information	188
Cargo and luggage.....	188
Winter driving tips	189
Trailer towing.....	192

3 Interior features

3-1. Using the touch screen	196
Touch screen	196
Setting the touch screen	198
3-2. Using the air conditioning system and defogger	204
Front air conditioning system (without rear air conditioning system).....	204

Front air conditioning system (with rear air conditioning system).....	212
Rear air conditioning system....	221
Rear window and outside rear view mirror defoggers	228
Windshield wiper de-icer.....	229

3-3. Using the audio system	230
Audio system type	230
Using the radio.....	233
Using the CD player.....	238
Playing MP3 and WMA discs.....	246
Using the DVD player	254
Playing DVD video/audio.....	257
Playing a video CD	270
DVD player and DVD video disc information	274
Optimal use of the audio/video system	278
Using the AUX adapter.....	282
Using the rear seat audio controls.....	283
Using the steering wheel audio switches.....	287
3-4. Using the rear seat entertainment system	289
Rear seat entertainment system features.....	289
Using the radio.....	297

1

2

3

4

5

6

Using the front DVD changer	298
Using the rear DVD player	299
Playing an audio CD/CD text	301
Playing WMA (front DVD changer only)/MP3 discs	302
Playing a DVD video/audio ...	303
Playing a video CD	316
DVD player and DVD video disc information	320
Using the video mode	331
Changing other setting	333
3-5. Using the hands-free system (for cellular phone)	335
Hands-free system (for cellular phone)	335
Using a Bluetooth® phone	339
Setting the hands-free system (for cellular phone)	351
3-6. Using the interior lights	377
Interior lights list	377
• Interior lights	379
• Personal lights	379
3-7. Using the storage features	381
List of storage features	381
• Glove box	383
• Coin holder	384
• Door pockets	385
• Cup holders	386
• Console box	387
• Cool box	389
• Auxiliary boxes	392
3-8. Other interior features	395
Sun visors	395
Vanity mirror	396
Clock	397
Outside temperature display	399
Ashtrays	400
Cigarette lighter	401
Power outlet	403
Heated steering wheel	405
Climate control seats	407
Armrest (5-seat models)	410
Rear seat relaxation system (4-seat models)	411
Retractable table	413
Rear sunshade	415
Rear door sunshades	418
Trunk storage extension	421
Coat hooks	423
Floor mat	424
Trunk features	425

4 Maintenance and care

- 4-1. **Maintenance and care** 430
 - Cleaning and protecting the vehicle exterior 430
 - Cleaning and protecting the vehicle interior 433
- 4-2. **Maintenance** 436
 - Maintenance requirements 436
 - Scheduled maintenance 439
- 4-3. **Do-it-yourself maintenance** 446
 - Do-it-yourself service precautions 446
 - Hood 449
 - Positioning the jack 450
 - Engine compartment 452
 - Tires 466
 - Tire inflation pressure 469
 - Wheels 471
 - Air conditioning filter 472
 - Electronic key battery 475
 - Checking and replacing fuses 477
 - Light bulbs 493

5 When trouble arises

- 5-1. **Essential information** 504
 - If your vehicle needs to be towed 504
 - If you think something is wrong 510
 - Fuel pump shut off system 511
- 5-2. **Steps to take in an emergency** 512
 - If a warning light turns on or a warning buzzer sounds... 512
 - If a warning message is displayed 517
 - If you have a flat tire 520
 - If the engine will not start 528
 - If the shift lever cannot be shifted from P 530
 - If the parking brake cannot be released 531
 - If you lose your keys 533
 - If the electronic key does not operate properly 534
 - If the battery is discharged 537
 - If your vehicle overheats 541
 - If the vehicle becomes stuck 544

1

2

3

4

5

6

6 Vehicle specifications

6-1. Specifications..... 546
 Maintenance data
 (fuel, oil level, etc.)..... 546
 Fuel information..... 555

6-2. Customization..... 556
 Customizable features 556

Index

Abbreviation list 562
 Abbreviation/Acronym list..... 562

Alphabetical index..... 563

What to do if... 572

1

2

3

4

5

6

7

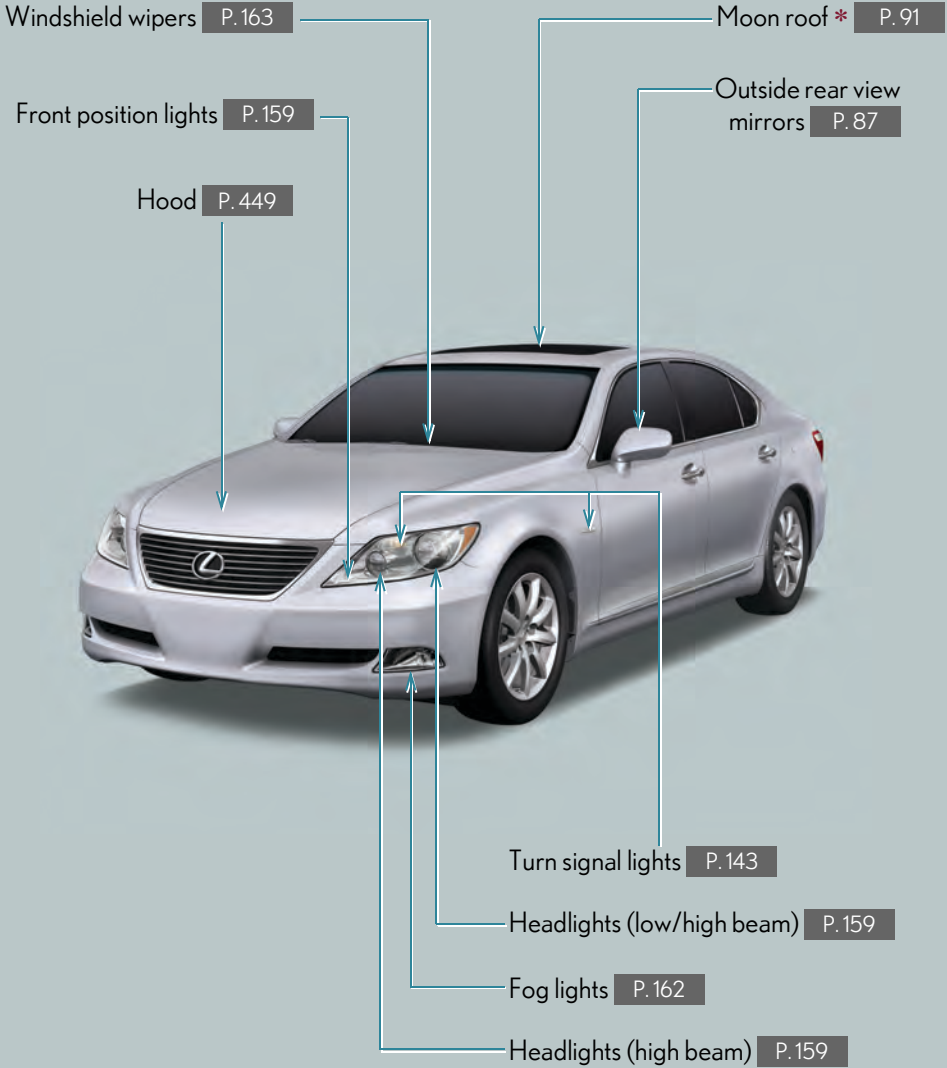

Fuel filler door P. 94

Doors P. 49

Turn signal lights P. 143

Rear window defogger P. 228

Trunk P. 54

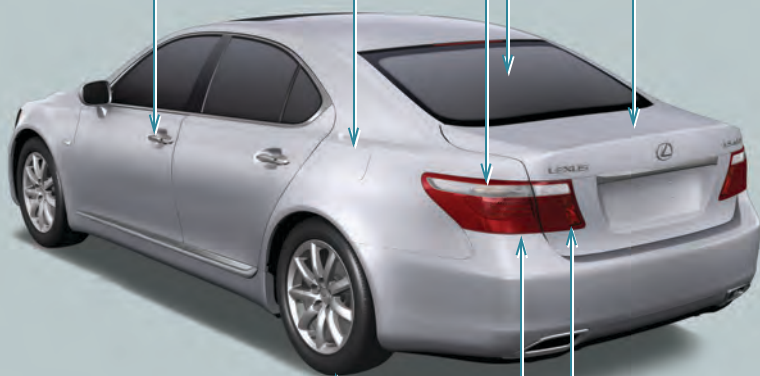

Tires

- Rotation P. 466
- Replacement P. 520
- Inflation pressure P. 469

Fog lights P. 162

Tail lights P. 159

*: If equipped

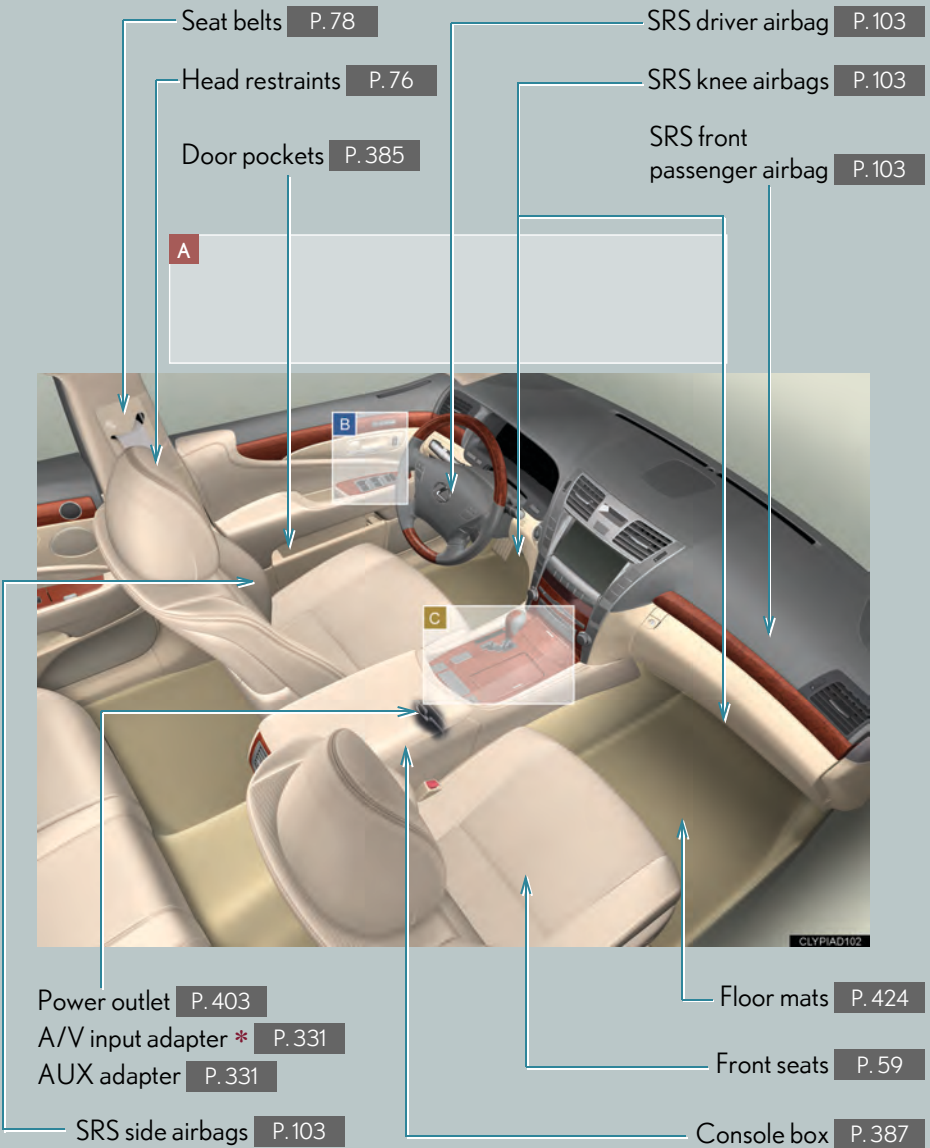

A

Anti-glare inside rear view mirror P. 86

Interior light P. 379

Personal lights P. 379

Moon roof switches * P. 91

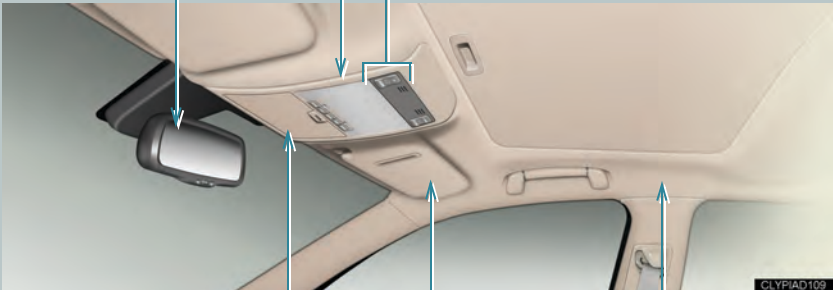

Auxiliary boxes P. 393

SRS curtain shield airbags P. 103

Vanity mirrors P. 396

Sun visors P. 395

*: If equipped

B

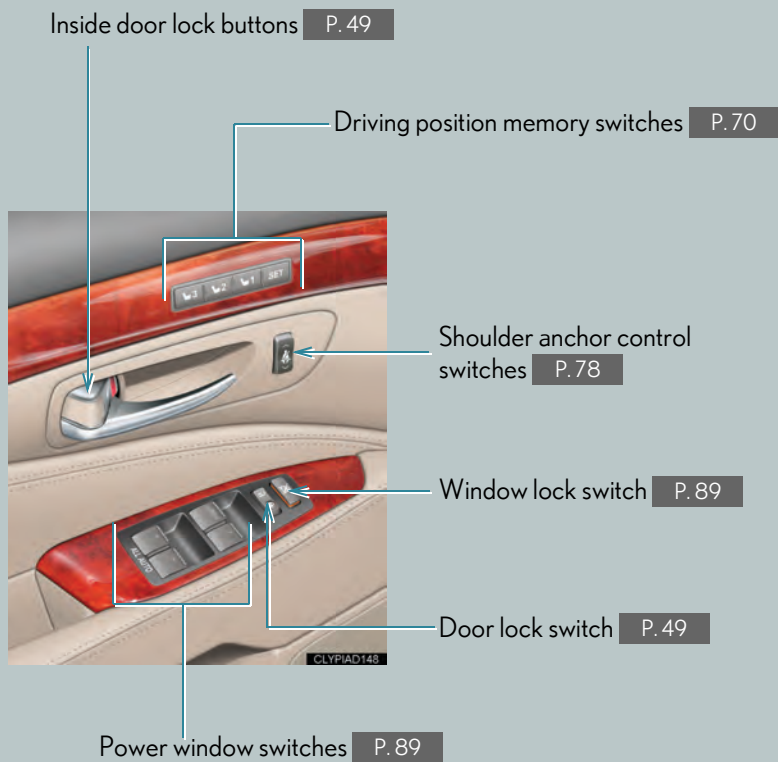

C

Automatic transmission shift lever P. 139

Cigarette lighter P. 401

Ashtray P. 400

Cup holders P. 386

Rear seat return switch P. 63,66

Rear climate control seat switches P. 407

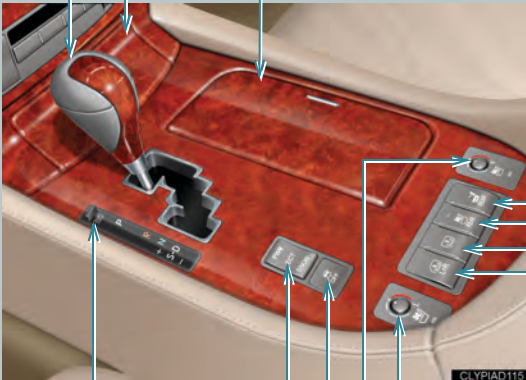

Shift lock override button P. 530

Rear sunshade switch P. 415

Rear door sunshade switch * P. 418

Front climate control seat switches P. 407

VSC off switch P. 184

Driving pattern selector switch P. 140

*: If equipped

Pictorial index

Instrument panel

- Headlight switch P. 159
- Turn signal lever P. 143
- Fog light switch P. 162

- Gauges and meters P. 149
- Multi-information display P. 155
- Windshield wiper and washer switch P. 163
- “ENGINE START STOP” switch P. 135

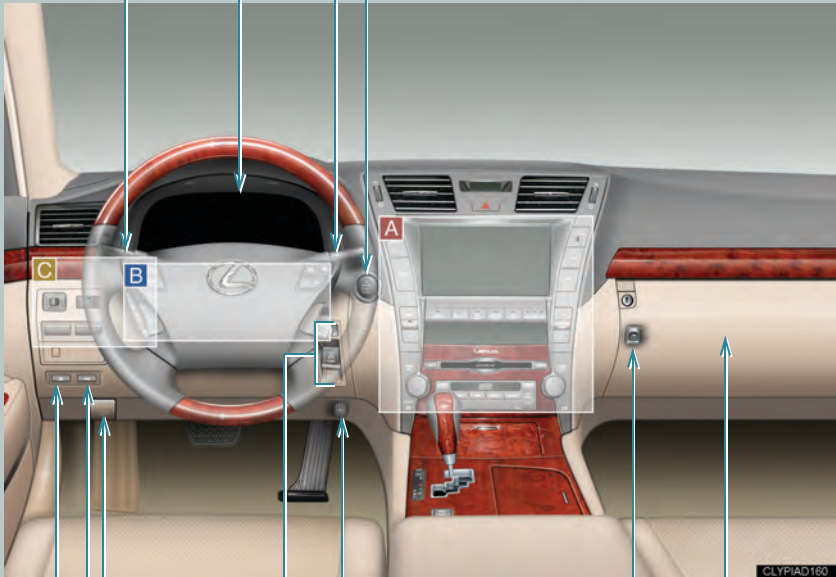

- Trunk opener main switch P. 55
- Glove box P. 383
- Volume adjust knob P. 37
- Parking brake switches P. 144
- Hood release lever P. 449
- Trunk opener P. 54
- Fuel filler door opener P. 94

A



*: If equipped

B

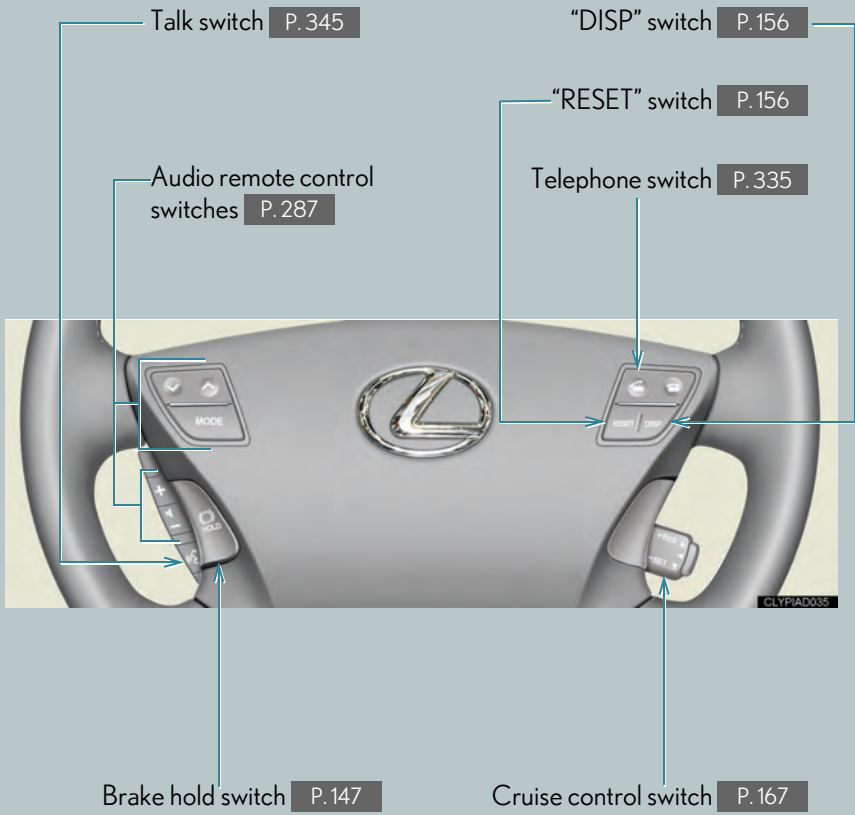

C



Outside rear view mirror
switches P. 87

Instrument panel light control
buttons P. 150

Headlight cleaner switch P. 166

Tilt and telescopic steering
control switch P. 84

Heated steering wheel switch *
P. 405

Lexus parking assist-sensor
switch * P. 171

"AFS OFF" switch P. 160

*: If equipped

Pictorial index

Rear interior (5-seat models)

Auxiliary boxes P. 393

Cool box * P. 389

Trunk storage extension *
P. 421

Head restraints P. 76

A

Seat position memory switches P. 74

Power window
switches P. 89

SRS side airbags
P. 103

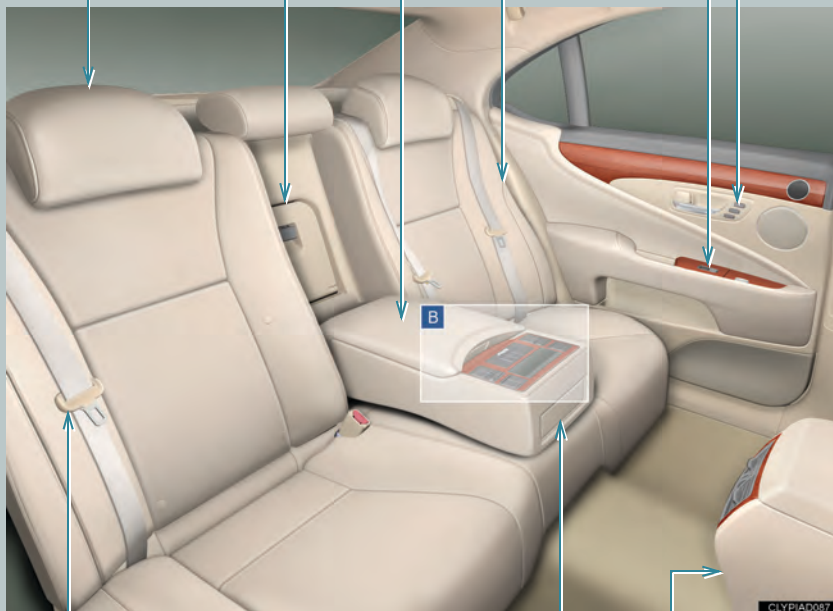

Seat belts P. 78

Cigarette lighter P. 401

Cup holders P. 386

A

Interior light P. 379

Personal lights P. 379

Rear seat entertainment system * P. 289

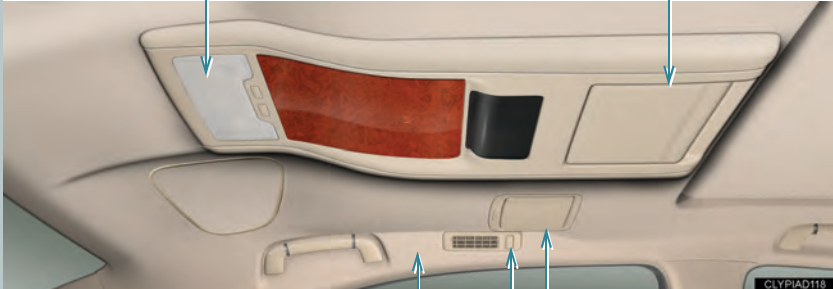

SRS curtain shield airbags P. 103

Vanity mirrors P. 396

Coat hooks P. 423

B

Power seat switches *
P. 63

Rear audio switches *
P. 283

Rear climate control
seat switches P. 407

Rear air conditioning
switches * P. 221

Rear door sunshade
switches * P. 418

Rear sunshade switch
P. 415

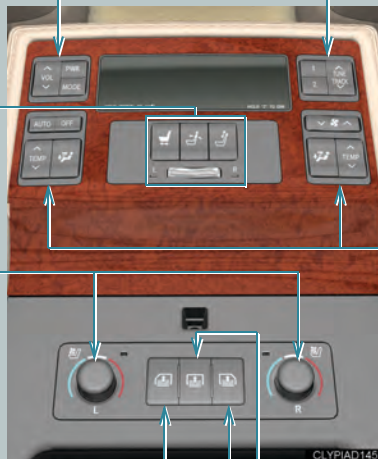

*: If equipped



A

Interior lights P. 379
Personal lights P. 379

Rear seat entertainment system P. 289

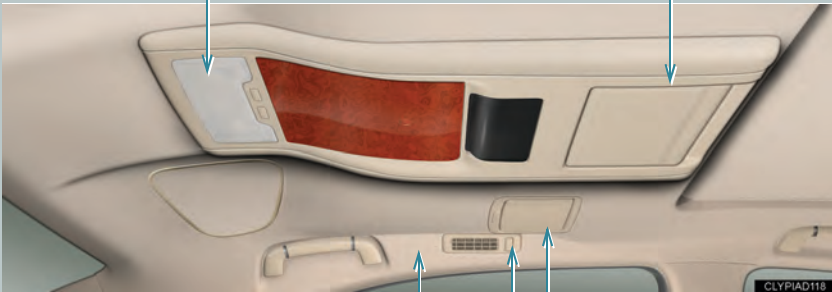

SRS curtain shield airbags P. 103

Vanity mirrors P. 396

Coat hooks P. 423

B

A/V input adapter P. 331

Cigarette lighters * P. 401

Power outlet * P. 403



Rear seat entertainment system controller P. 289

Cool box P. 389

Rear seat relaxation system controller P. 411

C

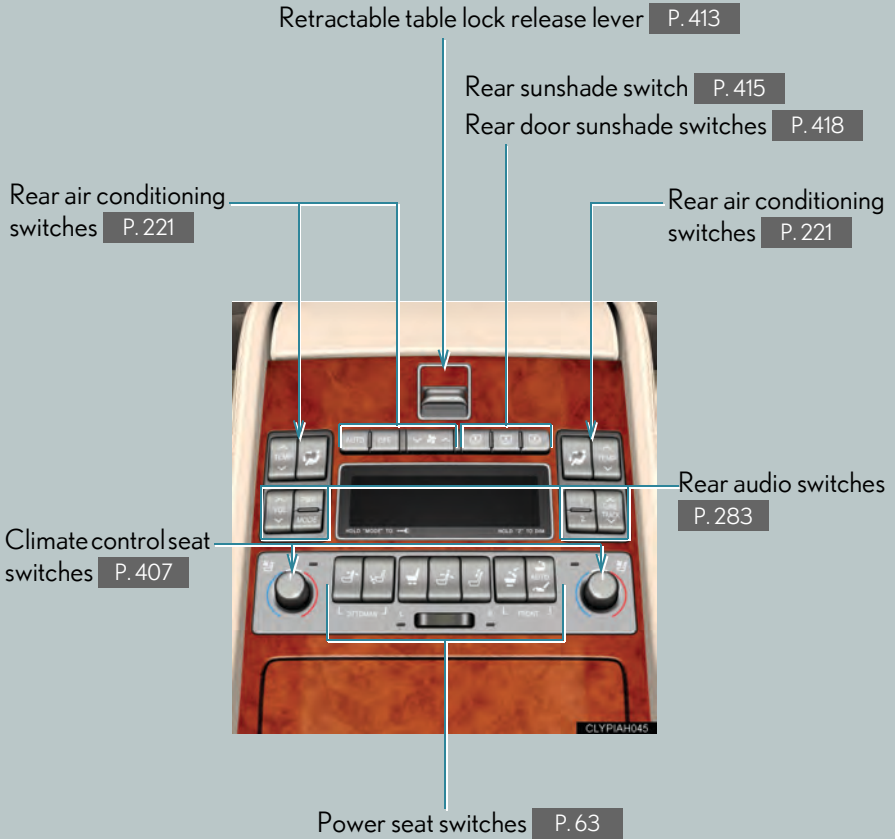

*: If equipped

For your information

Main Owner's Manual

Please note that this manual covers all models and all equipment, including options. Therefore, you may find some explanations for equipment not installed on your vehicle.

All specifications provided in this manual are current at the time of printing. However, because of the Lexus policy of continual product improvement, we reserve the right to make changes at any time without notice.

Depending on specifications, the vehicle shown in the illustrations may differ from your vehicle in terms of color and equipment.

Accessories, spare parts and modification of your Lexus

A wide variety of non-genuine spare parts and accessories for Lexus vehicles are currently available in the market. Using these spare parts and accessories which are not genuine Lexus products may adversely affect the safety of your vehicle, even though these parts may be approved by certain authorities in your country. Toyota Motor Corporation therefore cannot accept any liability or guarantee spare parts and accessories which are not genuine Lexus products, nor for replacement or installation involving such parts.

This vehicle should not be modified with non-genuine Lexus products. Modification with non-genuine Lexus products could affect its performance, safety or durability, and may even violate governmental regulations. In addition, damage or performance problems resulting from the modification may not be covered under warranty.

Installation of a mobile two-way radio system

As the installation of a mobile two-way radio system in your vehicle may affect electronic systems such as the multi-port fuel injection system/sequential multi-port fuel injection system, cruise control system, anti-lock brake system, SRS airbag system or seat belt pretensioner system, be sure to check with your Lexus dealer for precautionary measures or special instructions regarding installation.

Scrapping your Lexus

The SRS airbag and seat belt pretensioner devices in your Lexus contain explosive chemicals. If the vehicle is scrapped with the airbags and seat belt pretensioners left as they are, this may cause an accident such as fire. Be sure to have the systems of the SRS airbag and seat belt pretensioner removed and disposed of by a qualified service shop or by your Lexus dealer before you scrap your vehicle.

CAUTION

■ General precautions while driving

Driving under the influence: Never drive your vehicle when under the influence of alcohol or drugs that have impaired your ability to operate your vehicle. Alcohol and certain drugs delay reaction time, impair judgment and reduce coordination, which could lead to an accident that will hurt or kill you, your occupants or others.

Defensive driving: Always drive defensively. Anticipate mistakes that other drivers or pedestrians might make and be ready to avoid accidents.

Driver distraction: Always give your full attention to driving. Anything that distracts the driver, such as adjusting controls, talking on a cellular phone or reading can result in a collision with resulting death or serious injury to you, your occupants or others.

■ General precaution regarding children's safety

Never leave children unattended in the vehicle, and never allow children to have or use the key.

Children may be able to start the vehicle or shift the vehicle into neutral. There is also a danger that children may injure themselves by playing with the cigarette lighter, the windows, the moon roof, or other features of the vehicle. In addition, heat build-up or extremely cold temperatures inside the vehicle can be fatal to children.

Symbols used throughout this manual

Cautions & Notices

CAUTION

This is a warning against something which, if ignored, may cause injury to people. You are informed about what you must or must not do in order to reduce the risk of injury to yourself and others.

NOTICE

This is a warning against something which, if ignored, may cause damage to the vehicle or its equipment. You are informed about what you must or must not do in order to avoid or reduce the risk of damage to your Lexus and its equipment.

Safety symbol



Throughout this manual, you will also see the symbol of a circle with a slash through it. This means “Do not”, “Do not do this”, or “Do not let this happen”.

1-1. Key information.....	28	1-4. Opening and closing the windows and moon roof.....	89
Keys	28	Power windows	89
1-2. Opening, closing and locking the doors and trunk.....	33	Moon roof.....	91
Smart entry & start system	33	1-5. Refueling	94
Wireless remote control	47	Opening the fuel tank cap.....	94
Doors.....	49	1-6. Theft deterrent system	97
Trunk.....	54	Engine immobilizer system	97
1-3. Adjustable components (seats, mirrors, steering wheel).....	59	Alarm	99
Front seats	59	1-7. Safety information	101
Power rear seat (5-seat models)	63	Correct driving posture.....	101
Power rear seat (4-seat models)	66	SRS airbags.....	103
Driving position memory	70	Child restraint systems.....	115
Rear seat position memory	74	Installing child restraints	119
Head restraint	76		
Seat belts.....	78		
Steering wheel	84		
Anti-glare inside rear view mirror.....	86		
Outside rear view mirrors	87		

1-1. Key information

Keys

The following keys are provided with the vehicle.

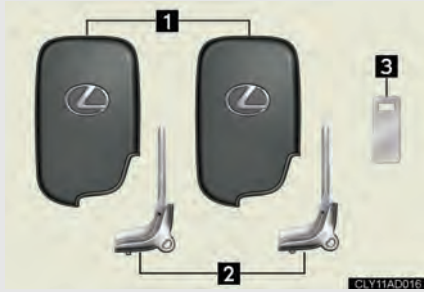

■ Card key (if equipped)



1 Electronic keys

- Operating the smart entry & start system (→P. 33)
- Operating the wireless remote control function (→P. 47)

2 Mechanical keys

3 Key number plate

1 Electronic key

Operating the smart entry & start system (→P. 33)

2 Mechanical key

The card key comes with an information card that includes instructions for use. Lexus recommends that you carry the information card with the card key.

Using the mechanical key



Take out the mechanical key.

The mechanical key can only be inserted in one direction, as the key only has grooves on one side. If the key cannot be inserted in a lock cylinder, turn it over and re-attempt to insert it.

After using the mechanical key, store it in the electronic key. Carry the mechanical key together with the electronic key. If the electronic key battery depletes or the entry function does not operate properly, you will need the mechanical key. (→P. 534)

■ Card key

- The mechanical key that is stored inside the card key should be used only if a problem arises, such as when the key does not operate properly.
- If it is difficult to take out the mechanical key, push down the lock release button using a pen tip etc. If it is difficult to pull it out, use a coin etc.



- To store the mechanical key in the card key, insert it inside while pressing the lock release button.



- If the battery cover is not installed and the battery falls out or if the battery was removed because the key got wet, reinstall the battery with the positive terminal facing the Lexus emblem.

- The card key is not waterproof.

■ When required to leave a key to the vehicle with a parking attendant

Turn the trunk opener main switch OFF and lock the glove box as circumstances demand. (→P. 55, 383)

Remove the mechanical key for your own use and provide the attendant with the electronic key only.

■ Key number plate

Keep the plate in a safe place such as your wallet, not in the vehicle. In the event that a mechanical key is lost, a new key can be made by your Lexus dealer, using the key number plate. (→P. 533)

■ Certification for the keys

Este equipamento está homologado pela ANATEL de acordo com os procedimentos regulamentados pela Resolução 242/2000 e atende aos requisitos técnicos aplicados.

Este equipamento opera em caráter secundário, isto é, não tem direito a proteção contra interferência prejudicial, mesmo de estações do mesmo tipo, e não pode causar interferência a sistemas operando em caráter primário.



For electronic keys



For card key

 NOTICE**■ To prevent key damage**

Observe the following.

- Do not drop the keys, subject them to strong shocks or bend them.
- Do not expose the keys to high temperatures for a long period of time.
- Do not get the keys wet or wash them in an ultrasonic washer etc.
- Do not attach metallic or magnetic materials to the keys or place the keys close to such materials.
- Do not disassemble the keys.
- Do not place the keys near objects that produce magnetic fields, such as TVs, audio systems, glass top ranges, or medical electrical equipment, such as low-frequency therapy equipment.

■ Precautions for handling the card keys

- Do not apply excess force when inserting the mechanical key to the card key. Doing so may damage the card key.
- If the battery or card key terminals get wet, the battery may corrode. If the key is dropped into water, or if drinking water etc. is spilled on the key, immediately remove the battery cover and wipe the battery and terminals. (To remove the battery cover, lightly grasp it and pull.) If the battery is corroded, have your Lexus dealer replace the battery.
- Do not crush the battery cover or use a screwdriver to remove the battery cover. Forcibly removing the battery cover may bend or damage the key.
- If the battery cover is frequently removed, the battery cover may become loose.
- When installing the battery, make sure to check the direction of the battery. Installing the battery in the wrong direction may cause the battery to deplete rapidly.
- The surface of the card key may be damaged, or its coating may peel off in the following situations.
 - The card key is carried together with hard objects, such as coins or keys.
 - The card key is scraped with a sharp object, such as a tip of mechanical pencil.
 - The surface of the card key is wiped with thinners or benzene.

1-2. Opening, closing and locking the doors and trunk Smart entry & start system

The following operations can be performed simply by carrying the electronic key (including the card key) on your person, for example in your pocket.

(The driver should always carry the electronic key.)

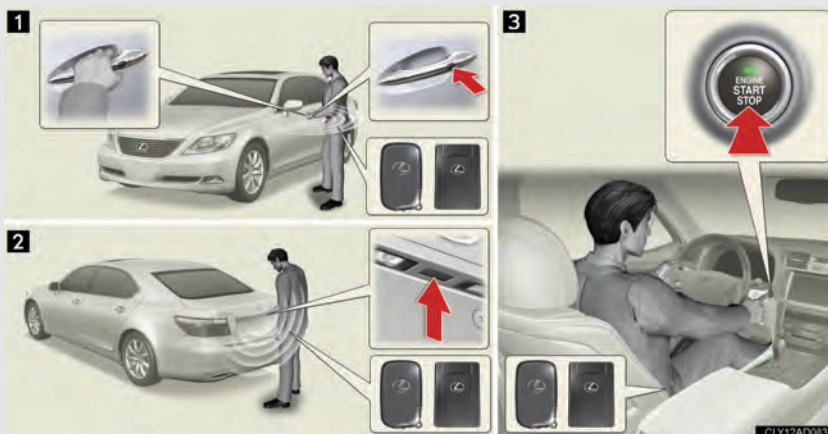

1 Locks and unlocks the doors (→P. 34)

2 Opens the trunk (→P. 34)

3 Starts and stops the engine (→P. 135)

Locking and unlocking the doors



Press the lock button to lock the door.

Pressing and holding the button closes the windows.

The moon roof will also close. (if equipped)



Grip the handle to unlock the door.

Make sure to touch the sensor on the back of the handle.

The door cannot be unlocked for 3 seconds after the door is locked.

Opening the trunk



Press the button.

Antenna location and effective range

Antenna location

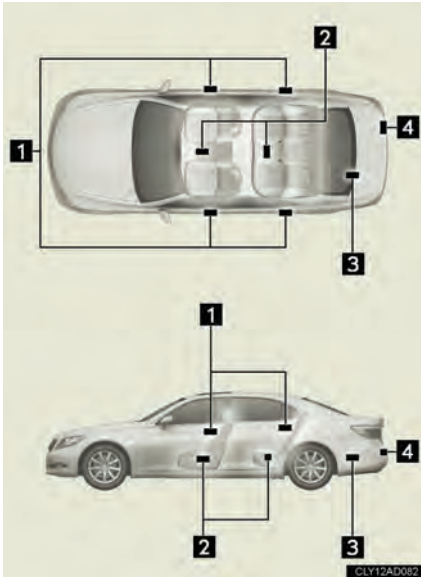

- 1 Antennas outside cabin
- 2 Antennas inside cabin
- 3 Antenna inside trunk
- 4 Antenna outside trunk

1

Before driving

■ **Effective range (areas within which the electronic key is detected)**

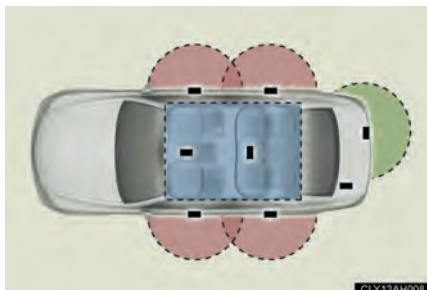

- When locking or unlocking the doors

The system can be operated when the electronic key is within about 70 cm (2.3 ft.) of an outside door handles. (Only the doors detecting the key can be operated.)

- When unlocking the trunk

The system can be operated when the electronic key is within about 70 cm (2.3 ft.) of the trunk release button.

- When starting the engine or changing “ENGINE START STOP” switch modes

The system can be operated when the electronic key is inside the vehicle.

■ Operation signals

Doors: The emergency flashers flash to indicate that the doors have been locked/unlocked. (Locked: Once; Unlocked: Twice)

Windows and moon roof: A buzzer sounds to indicate that the windows and moon roof are operating.

■ Door lock buzzer

If an attempt to lock the doors is made when a door is not fully closed, a buzzer sounds continuously. Fully close the door to stop the buzzer, and lock the vehicle once more.

■ Adjusting the volume of the buzzer

The operation signal buzzer and door lock buzzer can be set to the desired volume.

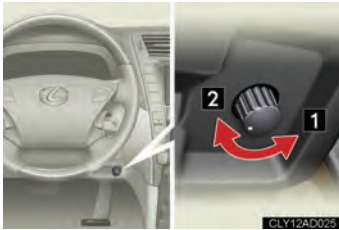

1 Increases the volume.

2 Decreases the volume.

The buzzer can be turned off by turning the knob fully clockwise.

■ Conditions affecting operation

The smart entry & start system uses weak radio waves. In the following situations, the communication between the electronic key and the vehicle may be affected, preventing the smart entry & start system, wireless remote control and engine immobilizer system from operating properly:

(Ways of coping: →P. 534)





- When the electronic key battery is depleted
- Near a TV tower, electric power plant, gas station, radio station, large display, airport or other facility that generates strong radio waves or electrical noise
- When carrying a portable radio, cellular phone, cordless phone or other wireless communication devices

- When the electronic key is in contact with, or is covered by the following metallic objects
 - Cards to which aluminum foil is attached
 - Cigarette boxes that have aluminum foil inside
 - Metallic wallets or bags
 - Coins
 - Hand warmers made of metal
 - Media such as CDs and DVDs
- When multiple electronic keys are in the vicinity
- When another wireless key (that emits radio waves) is being used nearby
- When carrying the electronic key together with the following devices that emit radio waves
 - Another vehicle's electronic key or a wireless key that emits radio waves
 - Personal computers or personal digital assistants (PDAs)
 - Digital audio players
 - Portable game systems
- If window tint with a metallic content or metallic objects are attached to the rear window



■ Switching the door unlock function

It is possible to set which doors the entry function unlocks.

STEP 1 Turn the “ENGINE START STOP” switch OFF.

STEP 2 When the indicator light on the key surface is not on, press and hold  ,  , or  for about 5 seconds while pressing and holding  .

The setting changes each time an operation is performed, as shown below. (When changing the setting continuously, release the buttons, wait for at least 5 seconds, and repeat step 2.)

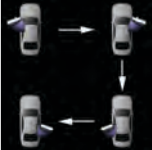
Multi-information display	Unlocking doors	Beep
	Hold a door handle to unlock all doors	Exterior: Beeps twice Interior: Rings once
	Hold the driver's door handle to unlock only the driver's door	Exterior: Beeps 3 times Interior: Rings once
	Hold a passenger's door handle to unlock all the doors	
	Hold the door handle to unlock the front and rear doors on your side	Exterior: Beeps 4 times Interior: Rings once
	Hold the door handle to unlock the door	Exterior: Beeps once Interior: Rings once

STEP 3 Unlock the doors using the wireless remote control and open one of the doors.

If a door is not opened within 30 seconds after the  button is pressed, the doors will be locked again and the alarm will automatically be set.

In case that the alarm is triggered, immediately stop the alarm.
(→P. 99)

■ Battery-saving function

In the following circumstances, the entry function is disabled in order to prevent the vehicle battery from discharging and electronic key battery from depleting.

- When the entry function has not been used for a month or more
- When the electronic key has been left within approximately 2 m (6 ft.) of the vehicle for 10 minutes or more

The system will resume operation when...

- The vehicle is locked using the door handle lock switch when carrying the electronic key on your person.
- The vehicle is locked/unlocked using the wireless remote control function.
(→P. 47)
- The vehicle is locked/unlocked using the mechanical key. (→P. 534)

■ Electronic key battery depletion

(→P. 475)

- To avoid serious deterioration, do not leave the electronic key within 1 m (3 ft.) of the following electrical appliances.
 - TVs
 - Personal computers
 - Cellular phones, cordless phones and battery chargers
 - Recharging cellular phones or cordless phones
 - Glass top ranges
 - Table lamps

■ To operate the system properly

Make sure to carry the electronic key when operating the system. Do not get the electronic key too close to the vehicle when operating the system from the outside of the vehicle.

Depending on the position and holding condition of the electronic key, the key may not be detected correctly and the system may not operate properly. (The alarm may go off accidentally, or the door lock prevention may not function.)

■ Note for the entry function

- Even when the electronic key is within the effective range (detection areas), the system may not operate properly in the following cases.
 - The electronic key is too close to the window or outside door handle, near the ground, or in a high place when the doors are locked or unlocked.
 - The electronic key is near the ground or in a high place, or too close to the rear bumper center when the trunk is unlocked.
 - The electronic key is on the instrument panel, rear package tray or floor, or in the glove box when the engine is started or “ENGINE START STOP” switch modes are changed.
- As long as the electronic key is within the effective range, the doors may be locked or unlocked by anyone.
- Even if the electronic key is not inside the vehicle, it may be possible to start the engine if the electronic key is near the window.
- The doors may unlock if a large amount of water splashes on the door handle, such as in the rain or in a car wash when the electronic key is within the effective range. (The door will automatically be locked after approximately 30 seconds if the doors are not opened and closed.)
- Gripping the door handle when wearing a glove may not unlock the door.
- If the wireless remote control is used to lock the doors when the electronic key is near the vehicle, there is a possibility that the door may not be unlocked by the entry function. (Use the wireless remote control to unlock the doors.)
- A sudden approach to the effective range or door handle may prevent the doors from being unlocked. In this case, return the door handle to the original position and check that the doors unlock before pulling the door handle again.

■ When the vehicle is not driven for extended periods

To prevent theft of the vehicle, do not leave the electronic key within 2 m (6 ft.) of the vehicle.

■ Security feature

If a door is not opened within approximately 30 seconds after the vehicle is unlocked, the anti-theft system automatically locks the vehicle again.

■ Alarms and warning indicators

A combination of exterior and interior alarms as well as warnings displayed on the multi-information display are used to prevent theft of the vehicle and unforeseeable accidents resulting from erroneous operation. Perform the appropriate correction procedure described in the following table.

Alarm	Situation	Correction procedure
Exterior alarm sounds once for 2 seconds.	An attempt was made to lock the doors using the entry function while the electronic key was still inside the passenger compartment.	Retrieve the electronic key from the passenger compartment and lock the doors again.
	The trunk was closed with the electronic key inside and all doors were locked.	Retrieve the electronic key from the trunk and close the trunk lid.
Exterior alarm sounds once for 60 seconds.	An attempt was made to exit the vehicle and lock the doors while carrying the electronic key without first turning the "ENGINE START STOP" switch OFF.	Turn the "ENGINE START STOP" switch OFF and lock the doors again.
Exterior alarm sounds once for 10 seconds.	An attempt was made to lock the vehicle while a door was open.	Close all of the doors and lock the doors again.

Alarm	Situation	Correction procedure
Interior alarm pings continuously.	The “ENGINE START STOP” switch was turned to ACCESSORY mode while the driver's door was open (or the driver's door was opened while the “ENGINE START STOP” switch was in ACCESSORY mode).	Turn the “ENGINE START STOP” switch OFF and close the driver's door.
	The “ENGINE START STOP” switch was turned OFF while the driver's door was open.	Close the driver's door.
Interior alarm sounds continuously. *1	When the “ENGINE START STOP” switch is in IGNITION ON or ACCESSORY mode, an attempt was made to open the door and exit the vehicle, and the shift lever was not in P.	Shift the shift lever to P and turn the “ENGINE START STOP” switch OFF.
Interior and exterior alarms sound continuously. *1	When the “ENGINE START STOP” switch is in IGNITION ON or ACCESSORY mode, the driver's door was closed after the key was carried outside the vehicle, and the shift lever was not in P.	Shift the shift lever to P, turn the “ENGINE START STOP” switch OFF and close the driver's door again.

Alarm	Situation	Correction procedure
Interior alarm pings once. ^{*1}	The electronic key has a low battery.	Replace the electronic key battery.
	An attempt was made to start the engine without the electronic key being present, or the electronic key was not functioning normally.	Start the engine with the electronic key present. ^{*2}
Interior alarm pings once and exterior alarm sounds 3 times. ^{*1}	The driver's door was closed after the key was carried outside the vehicle, and the "ENGINE START STOP" switch was not turned OFF.	Turn the "ENGINE START STOP" switch OFF and close the driver's door again.
	An occupant carried the electronic key outside the vehicle and closed the door while the "ENGINE START STOP" switch was not OFF.	Bring the electronic key back into the vehicle.

^{*1}: A warning message will be shown on the multi-information display in the instrument cluster.

^{*2}: If the engine does not start when the electronic key is inside the vehicle, the electronic key battery may be depleted or there may be difficulties receiving the signal from the key. (→P. 37)

■ If the smart entry & start system does not operate properly

- Locking and unlocking the doors and trunk: Use the mechanical key. (→P. 534)
- Starting the engine: →P. 535

■ When the electronic key battery is fully depleted

→P. 475

■ Customization

Settings (e.g. smart entry & start system) can be deactivated.
(→P. 556)

■ Certification for smart entry & start system

Este equipamento está homologado pela ANATEL de acordo com os procedimentos regulamentados pela Resolução 242/2000 e atende aos requisitos técnicos aplicados.

Este equipamento opera em caráter secundário, isto é, não tem direito a proteção contra interferência prejudicial, mesmo de estações do mesmo tipo, e não pode causar interferência a sistemas operando em caráter primário.



 **CAUTION**

■ **Caution regarding interference with electronic devices**

- People with implanted pacemakers or cardiac defibrillators should maintain a reasonable distance between themselves and from the smart entry & start system antennas. (→P. 35) The radio waves may affect the operation of such devices. If necessary, the entry function can be disabled. Ask your Lexus dealer for details, such as the frequency of radio waves and timing of emitting the radio waves. Then, consult your doctor to see if you should disable the entry function.
- Users of any electrical medical device other than implanted pacemakers and implanted cardiac defibrillators should consult the manufacturer of the device for information about its operation under the influence of radio waves.
Radio waves could have unexpected effects on the operation of such medical devices.

Ask your Lexus dealer for details for disabling the entry function.

1-2. Opening, closing and locking the doors and trunk Wireless remote control

The wireless remote control can be used to lock and unlock the vehicle and the trunk from outside the vehicle.



- 1 Locks all doors
- 2 Closes the windows (press and hold)
The moon roof will also close. (if equipped)
- 3 Unlocks all doors
- 4 Opens the windows (press and hold)
The moon roof will also open. (if equipped)
- 5 Opens the trunk (press and hold)
- 6 Sounds alarm (press and hold) (→P. 99)

■ Operation signals

Doors: The emergency flashers flash to indicate that the doors have been locked/unlocked. (Locked: Once; Unlocked: Twice)

Windows and moon roof: A buzzer sounds to indicate that the windows and moon roof are operating.

■ Door lock buzzer

If an attempt to lock the doors is made when a door is not fully closed, a buzzer sounds continuously. Fully close the door to stop the buzzer, and lock the vehicle once more.

■ Adjusting the volume of the buzzer

The operation signal buzzer and door lock buzzer can be set to the desired volume. (→P. 37)

■ Alarm

Using the wireless remote control to lock the door will set the alarm system.
(→P. 99)

■ Electronic key battery depletion

→P. 40

■ Security feature

→P. 42

■ If the wireless remote control does not operate properly

- Locking and unlocking the doors and trunk: Use the mechanical key. (→P. 534)
- Starting the engine: →P. 535

■ When the electronic key battery is fully depleted

→P. 475

■ Conditions affecting operation

→P. 37

■ Customization

Settings (e.g. trunk unlocking function) can be changed. (→P. 556)

1-2. Opening, closing and locking the doors and trunk

Doors

The vehicle can be locked and unlocked using the entry function, wireless remote control or door lock switch.

■ Entry function

→P. 34

■ Wireless remote control

→P. 47

■ Door lock switch

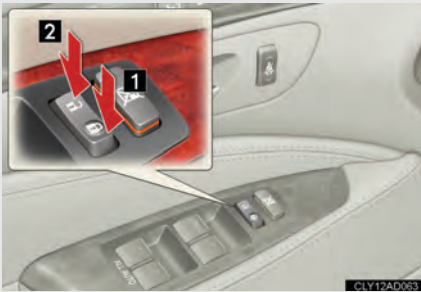

1 Locks all doors

2 Unlocks all doors

■ Inside lock button

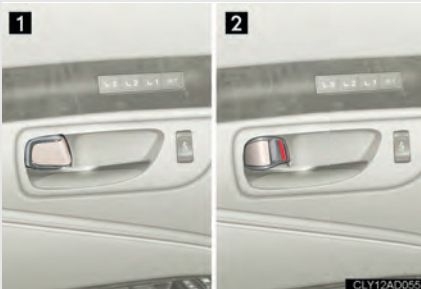

1 Locks the door

2 Unlocks the door

Pulling the door handle can open the driver's door even if the lock button is in the lock position.

Locking the driver's door from the outside without a key

STEP 1 Move the lock lever to the lock position.

STEP 2 Close the door while holding the door handle up.

The door cannot be locked if the "ENGINE START STOP" switch is in ACCESSORY or IGNITION ON mode, or the electronic key is left inside the vehicle.

The key may not be detected correctly and the door may be locked.

Rear door child-protector lock



The door cannot be opened from inside the vehicle when the locks are set.

These locks can be set to prevent children from opening the rear doors. Push down on each rear door switch to lock both rear doors.

Automatic door locking and unlocking systems

The following functions can be set or cancelled:

Function	Operation
Shift position linked door locking function	Shifting the shift lever out of P locks all doors.
Shift position linked door unlocking function	Shifting the shift lever to P unlocks all doors.
Speed linked door locking function	All doors are locked when the vehicle speed is approximately 20 km/h (12 mph) or higher.
Driver's door linked door unlocking function	All doors are unlocked when the driver's door is opened within 10 seconds after turning the "ENGINE START STOP" switch OFF.

■ Setting and canceling the functions

To switch between setting and canceling, follow the procedure below:

STEP 1 Close all the doors and switch the “ENGINE START STOP” switch to IGNITION ON mode. (Perform the step 2 within 20 seconds.)

STEP 2 Shift the shift lever to P or N, and press and hold the driver's door lock switch (1 or 2) for approximately 5 seconds and then release.

The shift lever and switch positions corresponding to the desired function to be set or canceled are shown as follows.



Function	Shift lever position	Switch position
Shift position linked door locking function	P	1
Shift position linked door unlocking function		2
Speed linked door locking function	N	1
Driver's door linked door unlocking function		2

When the setting or canceling operation is complete, all doors are locked and then unlocked.

■ Impact detection door lock release system

In the event that the vehicle is subject to a strong impact, all the doors are unlocked. Depending on the force of the impact or the type of accident, however, the system may not operate.

■ Door closer

In the event that a door is left slightly open, the door closer will automatically close it to the fully closed position.

- The door closer will operate regardless of “ENGINE START STOP” switch mode.
- The door closer will not function if the door has been closed while pulling the inside or outside door handle.
- The door can be opened by pulling the inside or outside door handle, even when the door closer is operating (except when the lock button is in the lock position or the child-protector lock is set).
- The motor sound may be heard for several seconds after the door closer closes the door. This does not indicate a malfunction.

■ Using the mechanical key

The doors can also be locked and unlocked with the mechanical key. (→P. 534)

■ Customization

Settings (e.g. unlocking function using a key) can be changed. (→P. 556)

 **CAUTION****■ To prevent an accident**

Observe the following precautions while driving the vehicle.

Failing to do so may result in a door opening and an occupant falling out, resulting in death or serious injury.

- Always use a seat belt.
- Always lock all doors.
- Ensure that all doors are properly closed.
- Driver's door: Do not pull on the inside door handle while the vehicle is in motion. The door will open even if it is locked.
- Set the rear door child protector locks when children are seated in the rear seat.

■ Door closer

In the event that a door is left slightly open, the door closer will automatically close it to the fully closed position.

If the child-protector lock is set, the door closer will not stop during operation even if an attempt is made to open the door from inside the vehicle. Be careful not to catch fingers or anything else in the door. Failure to do so may result in serious injury.

 **NOTICE****■ To prevent door closer malfunction**

Do not frequently repeat opening and closing of doors, or apply excessive force to a door while the door closer is operating.

1-2. Opening, closing and locking the doors and trunk

Trunk

■ Trunk opener



Press the opener switch.

The trunk lid automatically opens fully.

■ Entry function

→P. 34

■ Wireless remote control

→P. 47

Trunk closer switch



Pressing the switch closes the trunk lid automatically. (A buzzer sounds.)

Pressing the switch while the trunk lid is closing opens the trunk lid again.

Canceling the trunk opener feature



Turn the main switch in the glove box off to disable the trunk opener.

- 1** On
- 2** Off

The trunk lid cannot be opened even with the wireless remote control or the entry function.

■ Trunk handle



Use the trunk handle when closing the trunk.

■ Trunk easy closer

In the event that the trunk lid is left slightly open, the trunk easy closer will automatically close it to the fully closed position.

■ Function to prevent the trunk being locked with the electronic key inside (when all the doors are locked)

Closing the trunk lid with the electronic key left inside the trunk will sound an alarm. In this case, the trunk lid can be opened by pressing the button on the trunk lid.

■ Overload protection function

The trunk lid will not operate when excessive load is present on the top of the trunk lid.

■ Fall-down protection function (vehicles with a power trunk lid only)

While the trunk lid is opening automatically, applying excessive force to it will stop the opening operation to prevent the trunk lid from rapidly falling down.

■ Jam protection function

While the trunk lid is closing automatically, the trunk lid will stop closing and open if something gets caught.

■ Using the mechanical key

The trunk can be also opened using the mechanical key. (→P. 534)

■ Customization

Setting of power trunk lid function can be deactivated. (→P. 556)

 **CAUTION****■ Caution while driving**

Keep the trunk lid closed.

This not only keeps personal belongings from being thrown out, but also prevents exhaust gases from entering the vehicle.

■ When children are in the vehicle

- Never leave children unattended in the vehicle as they may lock themselves in the vehicle or trunk, which could cause the child to overheat or suffocate, resulting in death or serious injury.
- Do not allow a child to open or close the trunk lid. Doing so may cause the trunk lid to operate unexpectedly and part of the child's body may become caught.

■ Trunk easy closer

When the trunk lid is not completely closed, the trunk easy closer will automatically close it. Be careful not to catch fingers or anything else in the trunk lid. Failure to do so may result in serious injury.

■ Power trunk lid

- When the power trunk lid is operating, check the safety of the surrounding area and take extra care to prevent your fingers etc. from being caught in the trunk lid. Also pay attention to your personal belongings, such as bags or ties.
- Do not attach any accessories other than Lexus genuine parts to the trunk lid. Doing so may prevent the power trunk lid from operating automatically, resulting in a malfunction. It may also cause the trunk lid to fall down after it has fully opened, resulting in serious injury.
- Remove any heavy loads, such as snow, on the trunk lid before opening it. Failure to do so may cause the trunk lid to fall down due to the load after it opens.
- If any abnormality is detected while the power trunk lid is operating, such as when the trunk lid contacts an obstacle, the automatic operation may stop and change to manual operation. Before operating the power trunk lid, make sure that there are no obstacles.

■ Jam protection function

- Never use any part of your body to intentionally activate the jam protection function.
- The jam protection function may not work if something gets caught just before the trunk lid fully closes.

NOTICE

■ To prevent trunk easy closer malfunction

Do not apply force to the trunk lid while the trunk easy closer is operating.

■ To prevent damage to the power trunk lid

- Make sure that there is no luggage or snow on the trunk lid before operating the power trunk lid. In addition, make sure that there is no ice between the trunk lid and frame that prevents movement of the trunk lid. Operating the power trunk lid when excessive load is present on the trunk lid may cause a malfunction.
- Do not apply excessive force to the trunk lid while the power trunk lid is operating.

1-3. Adjustable components (seats, mirrors, steering wheel)

Front seats

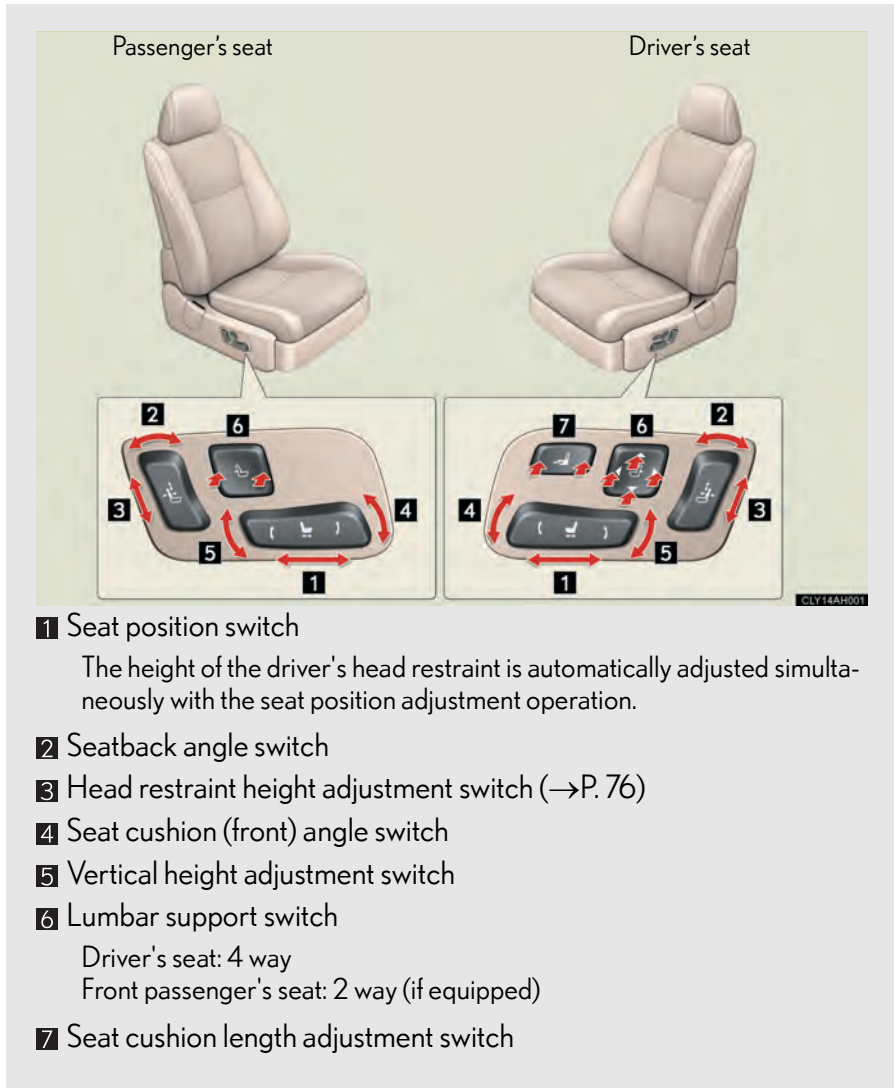

Seat operation switches on the side of the front passenger's seat



● Seatback angle switch

1 Forward

4-seat models: The head restraint rises and folds after the seat folds when the “ENGINE START STOP” switch is in IGNITION ON mode. The signal beeps when the operation is completed. If the switch is released during the operation, the head restraint will return to the neutral position.

2 Backward

4-seat models: If the head restraint is folded when the “ENGINE START STOP” switch is in IGNITION ON mode, it will return to the neutral position.

● Seat position switch

3 Forward

4 Backward

Operating the front passenger's seat from the rear seat (4-seat models)

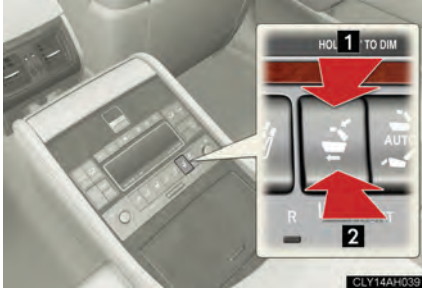

- 1 Moves the front passenger's seat forward

The signal beeps when the seat operation stops at the forward limit.

- 2 Moves the front passenger's seat backward

The seatback will return to the neutral position. If the head restraint is folded, it will rise before the seatback moves.

Switches on the side of the front passenger's seat (4-seat models)

In the following situations, the head restraint does not move even when the switch is operated:

- The "ENGINE START STOP" switch is OFF.
- The weight of an occupant or heavy object, etc. is detected in the front passenger's seat.
- The front passenger's seat belt is in use.
- The front passenger's door is open.

Operating the front passenger's seat from the rear seat (4-seat models)

The front passenger's seat can be operated when the "ENGINE START STOP" switch is in IGNITION ON mode. However, in the following situations, the front passenger's seat does not move even when the switch is operated:

- The weight of an occupant or heavy load etc. is detected on the front passenger's seat.
- The front passenger's seat belt is in use.
- The front passenger's door is open. (The front seat will not move forward.)

Seat cushion automatic length adjustment (driver's seat only)

The seat cushion length will automatically be adjusted to prevent the seat cushion from contacting the area around the instrument panel while the seat position is being adjusted.

■ When the retractable table is in use (4-seat models)

The seat operation will stop if a front seat is going to contact the retractable table while the seat is being moved backward. (A warning message will be shown on the multi-information display.)

CAUTION

■ Seat adjustment

To reduce the risk of sliding under the lap belt during a collision, do not recline the seat more than necessary.

If the seat is too reclined, the lap belt may slide past the hips and apply restraint forces directly to the abdomen, or your neck may contact the shoulder belt, increasing the risk of death or serious injury in the event of an accident.

Adjustments should not be made while driving as the seat may unexpectedly move and cause the driver to lose control of the vehicle.

■ Operating the front passenger's seat from the driver's seat or rear seat

Do not operate the front passenger's seat when a passenger is seated in it. In addition, do not let anyone sit down in the front passenger's seat while the seat is being operated or when the head restraint is being tilted forward. The front passenger may catch their legs between the instrument panel and seat, or the head restraint may interfere with their head, resulting in injury.

NOTICE

■ Operating the front passenger's seat from the driver's seat or rear seat

Before operating the front passenger's seat, make sure that there is no luggage or any other objects on the seat or in the footwell that could prevent its operation.

Failure to do so may result in excess force being applied, causing damage to the seat and/or the luggage.

Power rear seat (5-seat models)



1 Seat selection switch

The indicator light for the seat that can be operated comes on.

2 Seat position adjustment switch

3 Seatback upper angle adjustment switch

4 Head restraint height adjustment switch (→P. 76)

The seat return function linked to the door opening operation allows the seat to automatically return to the neutral position for easier access to and from the vehicle.

Returning the rear seat from the front seats



The seat will return to the neutral position while the button is pressed and held.

■ Cancelling the seat return function



Pressing the “C” button will disable the seat return function. When disabled, the seat will not return when the door is opened.

The indicator light comes on when the seat return function is disabled.

Pressing the button again will enable the seat return function.

Performing either of the following cancels the seat returning operation.

- Press the SET, M or C button.
- Press any of the seat adjustment switches.

■ Operating the seat return function after the “ENGINE START STOP” switch OFF

The seat will automatically return to the neutral position if the door is opened within 45 seconds after the engine is turned off.

 **CAUTION****■ Seat adjustment**

To reduce the risk of sliding under the lap belt during a collision, do not recline the seat more than necessary.

If the seat is too reclined, the lap belt may slide past the hips and apply restraint forces directly to the abdomen, or your neck may contact the shoulder belt, increasing the risk of death or serious injury in the event of an accident.

Adjustments should not be made while driving as the seat may unexpectedly move and cause the driver to lose control of the vehicle.

■ When adjusting the seat position

Keep sufficient footwell space to prevent your feet from being caught by the front seat.

■ When returning the rear seats to the neutral position

Wait until passengers have gotten off the rear seat before operating the switch to avoid injuring the passengers.

Power rear seat (4-seat models)



The right-hand rear seat is a relaxation seat, which is equipped with a seatback angle adjustment function and an ottoman.

1 Seat selection switch

The indicator light for the seat that can be operated comes on.

2 Seat position adjustment switch

3 Seatback upper angle adjustment switch

4 Head restraint height adjustment switch (→P. 76)

5 Seatback angle adjustment switch

6 Ottoman angle adjustment switch

7 Front passenger's seat control switch (→P. 61)

8 Relaxation mode switch

The seat return function linked to the door opening operation allows the seat to automatically return to the neutral position for easier access to and from the vehicle.

Returning the rear seat from the front seats



The seat will return to the neutral position while the button is pressed and held.

Relaxation mode operation

Relaxation mode can be entered by operating a switch. The front passenger seat will move forward, and then the seatback of the relaxation seat will recline and the ottoman will simultaneously rise.

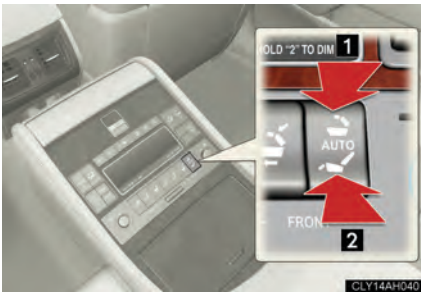

Pressing the switch will cause a beep to sound and operation will start.

- 1** Enters relaxation mode
- 2** Returns to the neutral position.

To stop the operation part-way through, press either side of the switch again, or press any other seat adjustment button.

■ Relaxation mode

Relaxation mode can be entered when the “ENGINE START STOP” switch is in IGNITION ON mode. However, in the following situations, relaxation mode cannot be entered even when the switch is operated:

- The weight of an occupant or heavy object etc. is detected on the front passenger's seat.
- The front passenger's seat belt is in use.
- The front passenger's door is open. (The front seat will not move forward.)

■ Cancelling the seat return operation



Pressing the “C” button will disable the seat return function. When disabled, the seat will not return when the door is opened.

The indicator light comes on when the seat return function is disabled.

Pressing the button again will enable the seat return function.

Performing either of the following cancels the seat returning operation.

- Press the SET, M or C button.
- Press any of the seat adjustment switch.

■ Operating the seat return function after the “ENGINE START STOP” switch OFF

- The rear seat can be returned to the neutral position as long as the relaxation mode switch is operated within 45 seconds after the “ENGINE START STOP” switch is turned OFF.
- The seat return function is available for 45 seconds after the “ENGINE START STOP” switch is turned OFF.

■ Seat operation automatic stop function

If the rear seat and front passenger seat are going to come in contact with each other while either of them is being operated, the signal will beep and seat operation will stop.

 **CAUTION**
■ Seat adjustment

To reduce the risk of sliding under the lap belt during a collision, do not recline the seat more than necessary.

If the seat is too reclined, the lap belt may slide past the hips and apply restraint forces directly to the abdomen, or your neck may contact the shoulder belt, increasing the risk of death or serious injury in the event of an accident.

Adjustments should not be made while driving as the seat may unexpectedly move and cause the driver to lose control of the vehicle.

■ When adjusting the seat position and ottoman angle

Keep sufficient footwell space to prevent your feet from being caught by the front seat.

■ When returning the rear seats to the neutral position

Wait until passengers have gotten off the rear seat before operating the switch to avoid injuring the passengers.

■ Using the ottoman

- Do not sit on the ottoman.

If someone sits on the ottoman, the seat belt cannot be fitted properly, and they may be thrown from the seat resulting in death or serious injury in the event of an accident or sudden braking.

- When getting in or out of the vehicle, retract the ottoman. If the ottoman is not retracted, it may cause a fall, resulting in injury.

 **NOTICE**
■ To prevent an ottoman malfunction

- Do not place any objects in the rear seat footwell that could prevent the operation of the ottoman.
- Do not place heavy luggage on the ottoman.

Driving position memory

Your preferred driving position (the position of the driver's seat and steering wheel, angle of the outside rear view mirrors and height of seat belt) can be memorized and recalled with the touch of a button. It is also possible to set this function to activate automatically when the doors are unlocked. Three different driving positions can be entered into memory.

■ Entering a position to memory

Check that the shift lever is set in P.

STEP 1 Switch to IGNITION ON mode.

STEP 2 Adjust the driver's seat, steering wheel, outside rear view mirrors and seat belt height to the desired positions.



While pushing the SET button, press button 1, 2 or 3 until the signal beeps.

If the selected button has already been preset, the previously recorded position will be overwritten.

■ Recalling the memorized position

Check that the shift lever is set in P.

STEP 1 Switch to IGNITION ON mode.



Press button 1, 2 or 3 to recall the memorized position.

Linking driving position memory with door unlock operation

Record your driving position to button 1, 2 or 3 before performing the following.

- Using the wireless remote control

STEP 1 Turn the “ENGINE START STOP” switch OFF and close the driver's door.



While pressing the desired button (1, 2 or 3), press  on the wireless remote control until the signal beeps.

The driving position is recalled when the driver's door is unlocked using the entry function or wireless remote control and the driver's door is opened.

STEP 3 Open one of the doors

If a door is not opened within 30 seconds after  is pressed, the doors will be locked again and the alarm will automatically be set.

In case that the alarm is triggered, immediately stop the alarm. (→P. 99)

- Using the door lock switch

Carry only the key (including card key) to which you want to link the driving position. If 2 or more keys are in the vehicle, the driving position cannot be linked properly.

STEP 1 Turn the “ENGINE START STOP” switch OFF and close the driver's door.



While pressing the desired button (1, 2 or 3), press the lock or unlock side on the door lock switch (either the driver or passenger side) until the signal beeps.

The driving position is recalled when the driver's door is unlocked using the entry function or wireless remote control and the driver's door is opened.

■ Canceling the linked door unlock operation

STEP 1 Turn the “ENGINE START STOP” switch OFF and close the driver's door.

STEP 2 Using the wireless remote control: While pressing the SET button, press **1** on the wireless remote control until the signal beeps.

Using the door lock switch: While pressing the SET button, press the lock or unlock side on the door lock switch until the signal beeps.

■ Operating the driving position memory after turning the “ENGINE START STOP” switch OFF

Memorized positions (except the steering wheel position) can be recalled by operating button “1”, “2” or “3” within 30 seconds after the driver's door has been opened even after the “ENGINE START STOP” switch is turned OFF.

■ To cancel seat position recall

Perform any one of the following operations.

- Press the SET button.
- Press button 1, 2 or 3.
- Adjust the seat using the switches (only cancels seat position recall).

■ When the retractable table is in use (4-seat models)

The seat operation will stop if a front seat is going to contact the retractable table while the seat is being moved backward. (A warning message will be shown on the multi-information display.)

 **CAUTION**

■ Seat adjustment caution

Take care during seat adjustment so that the seat does not strike the rear passenger or squeeze your body against the steering wheel.

Rear seat position memory

Your preferred rear seat position can be memorized and recalled with the touch of a button.

■ Entering a position to memory

STEP 1 Switch to IGNITION ON mode.

STEP 2 Adjust the rear seat to the desired position.

STEP 3



Press the SET button until the signal beeps.

If the preset is being used, the previously recorded seat position will be overwritten.

■ Recalling the memorized position



Press the M button until the signal beeps.

Relaxation seat: The memorized position will only be recalled if the ottoman is in a position higher than the memorized position. It will not move in an upward direction.

■ Seat return function linked to the door opening operation

When the door is opened, the rear seat will automatically return to the neutral position. This function is available for 45 seconds after the “ENGINE START STOP” switch is turned OFF.

■ Operating the rear seat position memory system after turning the engine off

The seat will automatically return to the neutral position as long as the door is opened within 45 seconds after the “ENGINE START STOP” switch is turned OFF.

■ Canceling the seat position recall or return function



Pressing the “C” button will disable the seat position recall or seat return function.

The indicator light comes on when the function is disabled.

Pressing the button again will enable the seat position recall or seat return function.

Performing either of the following cancels the seat returning operation.

- Press the “SET”, “M” or “C” button.
- Press any of the seat adjustment switches.

⚠ CAUTION

■ Seat adjustment caution

Take care during seat adjustment so that the rear passengers do not strike the front seats.

Head restraint

■ Front seats

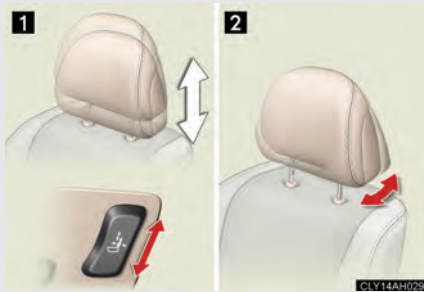

- 1 Vertical adjustment
→P. 59
- 2 Horizontal adjustment
4-seat models: Driver's seat only

■ Outside rear seats

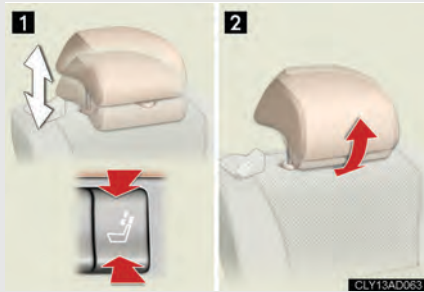

- 1 Vertical adjustment
5-seat models: →P. 63
4-seat models: →P. 66
- 2 Horizontal adjustment

■ Rear center seat (5-seat models)

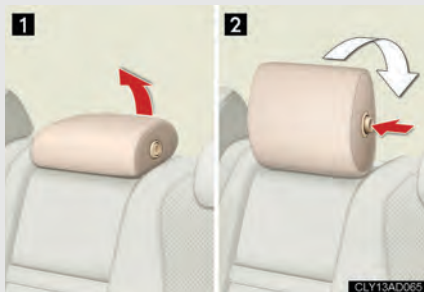

- 1 To use
- 2 To fold

■ Removing the head restraints

For removal and installation of the head restraint, contact your Lexus dealer.

■ Adjusting the height of the head restraints (except rear center seat)



Make sure that the head restraints are adjusted so that the center of the head restraint is closest to the top of your ears.

■ Head restraints of different seats

The head restraints are specially designed for the seats on which they are installed.

⚠ CAUTION

■ Head restraint precautions

Observe the following precautions regarding the head restraints. Failure to do so may result in death or serious injury.

- Adjust the head restraints to the correct position at all times.
- Do not drive with the head restraints removed.

Seat belts

Make sure that all occupants are wearing their seat belts before driving the vehicle.

■ Correct use of the seat belts



- Extend the shoulder belt so that it comes fully over the shoulder, but does not come into contact with the neck or slide off the shoulder.
- Position the lap belt as low as possible over the hips.
- Adjust the position of the seatback. Sit up straight and well back in the seat.
- Do not twist the seat belt.

■ Fastening and releasing the seat belt

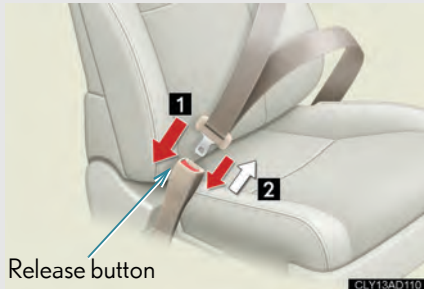

1 Fastening the belt

Push the tab into the buckle until a clicking sound is heard.

2 Releasing the belt

Press the release button. If the seat belt cannot be pulled out of the retractor, firmly pull the belt and release it.

■ Adjusting the seat belt shoulder anchor height (front seats)

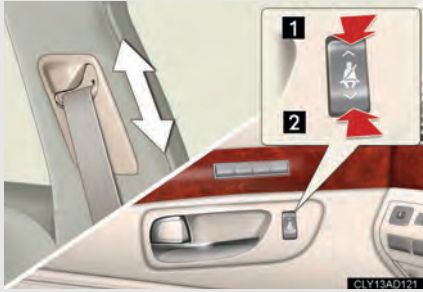

- 1 Up
- 2 Down

Seat belt comfort guide (outside rear seats)



If the shoulder belt sits close to a person's neck, slide the seat belt comfort guide forward.

Seat belt pretensioners (front and outside rear seats)



The pretensioner helps the seat belt to quickly restrain the occupant by retracting the seat belt when the vehicle is subjected to certain types of severe frontal collision.

The pretensioner may not activate in the event of a minor frontal impact, a side impact or a rear impact.

■ Emergency locking retractor (ELR)

The retractor will lock the belt during a sudden stop or on impact. It may also lock if you lean forward too quickly. A slow, easy motion will allow the belt to extend so that you can move around fully.

■ Automatic locking retractor (ALR)

When a rear passenger's shoulder belt is completely extended and then retracted even slightly, the belt is locked in that position and cannot be extended. This feature is used to hold the child restraint system (CRS) firmly. To free the belt again, fully retract the belt and then pull the belt out once more. (→P. 119)

■ Pregnant women



Obtain medical advice and wear the seat belt in the proper way. (→P. 78)

Women who are pregnant should position the lap belt as low as possible over the hips in the same manner as other occupants. Extend the shoulder belt completely over the shoulder and position the belt across the chest. Avoid belt contact over the rounding of the abdominal area.

If the seat belt is not worn properly, not only a pregnant woman, but also the fetus could suffer death or serious injury as a result of sudden braking or a collision.

■ People suffering illness

Obtain medical advice and wear the seat belt in the proper way.

■ Child seat belt usage

The seat belts of your vehicle were principally designed for persons of adult size.

- Use a child restraint system appropriate for the child, until the child becomes large enough to properly wear the vehicle's seat belt. (→P. 115)
- When the child becomes large enough to properly wear the vehicle's seat belt, follow the instructions on P. 78 regarding seat belt usage.

■ Automatic adjustment of the seat belt shoulder anchor height (driver's seat only)

A desired seat belt shoulder anchor height can be entered to memory and recalled automatically by the driving position memory. (→P. 70)

■ Replacing the belt after the pretensioner has been activated

The seat belts cannot be used after a pretensioner has been activated. After an accident, have the pretensioners inspected by your Lexus dealer. Make sure the pretensioners are replaced if they have been activated.

■ Seat belt regulations

If seat belt regulations exist in the country where you reside, please contact your Lexus dealer, for seat belt replacement or installation.

 **CAUTION**

■ **Wearing a seat belt**

Observe the following precautions to reduce the risk of injury in the event of sudden braking or an accident.

Failing to do so may cause death or serious injury.

- Ensure that all passengers wear a seat belt.
- Always wear a seat belt properly.
- Each seat belt should be used by one person only. Do not use a seat belt for more than one person at once, including children.
- Lexus recommends that children be seated in the rear seat and always use a seat belt and/or an appropriate child restraint system.
- To achieve a proper seating position, do not recline the seat more than necessary. The seat belt is most effective when the occupants are sitting up straight and well back in the seats.
- Do not wear the shoulder belt under your arm.
- Always wear your seat belt low and snug across your hips.

■ **Seat belt pretensioners**

Do not place anything, such as a cushion, on the front passenger's seat. Doing so will disperse the passenger's weight, which prevents the sensor from detecting the passenger's weight properly. As a result, the seat belt pretensioner for the front passenger's seat may not activate in the event of a collision.

 **CAUTION****■ Seat belt damage and wear**

- Do not damage the seat belts by allowing the belt, plate, or buckle to be jammed in the door.
- Inspect the seat belt system periodically. Check for cuts, fraying, and loose parts. Do not use a damaged seat belt until it is replaced. Damaged seat belts cannot protect an occupant from death or serious injury.
- Ensure that the belt and tab are locked and the belt is not twisted. If the seat belt does not function correctly, immediately contact your Lexus dealer.
- Replace the seat assembly, including the belts, if your vehicle has been involved in a serious accident, even if there is no obvious damage.
- Do not attempt to install, remove, modify, disassemble or dispose of the seat belts. Have any necessary repairs carried out by your Lexus dealer. Inappropriate handling of the pretensioner may prevent it from operating properly resulting in death or serious injury.

1-3. Adjustable components (seats, mirrors, steering wheel)

Steering wheel

The steering wheel can be adjusted to a comfortable position while the “ENGINE START STOP” switch is in ACCESSORY or IGNITION ON mode.

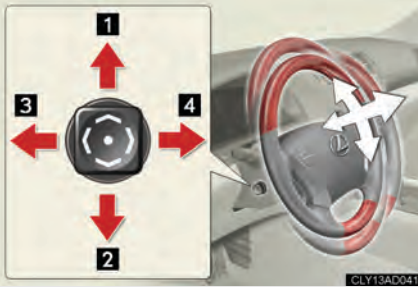

- 1 Up
- 2 Down
- 3 Away from the driver
- 4 Toward the driver

Auto tilt away



When the “ENGINE START STOP” switch is turned OFF, the steering wheel returns to its stowed position by moving up and away to enable easier driver entry and exit.

Switching to ACCESSORY or IGNITION ON mode will return the steering wheel to the original position.

■ Automatic adjustment of the steering position

A desired steering position can be entered to memory and recalled automatically by the driving position memory. (→P. 70)

 **CAUTION**

■ **Caution while driving**

Do not adjust the steering wheel while driving.

Doing so may cause the driver to mishandle the vehicle and cause an accident, resulting in death or serious injury.

1-3. Adjustable components (seats, mirrors, steering wheel)

Anti-glare inside rear view mirror

In automatic mode, sensors are used to detect the headlights of vehicles behind and automatically reduce the reflected light.



Turns automatic mode on/off

The indicator comes on when automatic mode is turned on.

The mirror will revert to automatic mode each time the "ENGINE START STOP" switch is turned on.

■ To prevent sensor error



To ensure that the sensors operate properly, do not touch or cover them.

⚠ CAUTION

■ Caution while driving

Do not adjust the position of the mirror while driving.

Doing so may lead to mishandling of the vehicle and cause an accident, resulting in death or serious injury.

Outside rear view mirrors

Mirror angle can be adjusted using the switch when the “ENGINE START STOP” switch is in ACCESSORY or IGNITION ON mode.

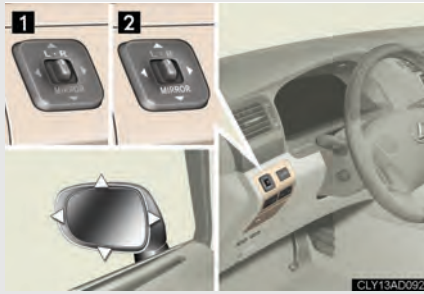

- 1 Selects a mirror to adjust (L: left or R: right)
- 2 Adjusts the mirror up, down, in, or out using the switch

Folding and extending the mirrors

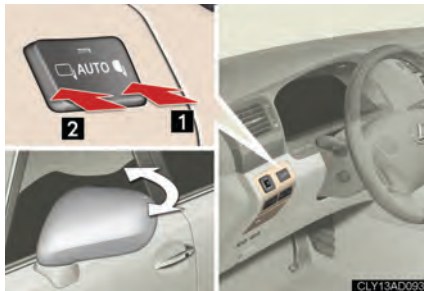

- 1 Folds the mirrors
- 2 Extends the mirrors

Putting the outside rear view mirror folding switch in the neutral position sets the mirrors in automatic mode. Automatic mode allows the folding or extending of the mirrors to be linked to locking/unlocking of the doors.

■ When the mirrors are fogged up

Turn on the mirror defoggers to defog the mirrors. (→P. 228)

■ Automatic adjustment of the mirror angle

A desired mirror face angle can be entered to memory and recalled automatically by the driving position memory. (→P. 70)

■ Linked mirror function when reversing

The outside rear view mirrors will automatically angle downwards when the vehicle is reversing in order to give a better view of the ground. However, this function will not operate when the mirror select switch is in the neutral position (between L and R).

■ Auto anti-glare function

When the anti-glare inside rear view mirror is set to automatic mode, the outside rear view mirrors will activate in conjunction with the anti-glare inside rear view mirror to reduce reflected light. (→P. 86)

CAUTION

■ When driving the vehicle

Observe the following precautions while driving.

Failing to do so may result in loss of control of the vehicle and cause an accident, resulting in death or serious injury.

- Do not adjust the mirrors while driving.
- Do not drive with the mirrors folded.
- Both the driver and passenger side mirrors must be extended and properly adjusted before driving.

■ When a mirror is moving

To avoid personal injury and mirror malfunction, be careful not to get your hand caught by the moving mirror.

■ When the mirror defoggers are operating

Do not touch the surface of the mirror, as it may be hot.

1-4. Opening and closing the windows and moon roof

Power windows

The power windows can be opened and closed using the following switches.

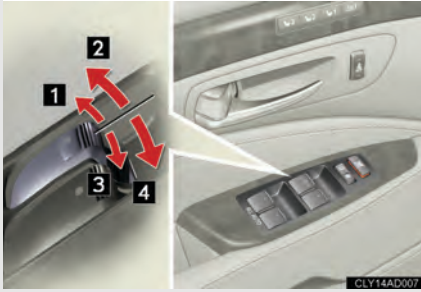

- 1 Closing
- 2 One-touch closing*
- 3 Opening
- 4 One-touch opening*

*: Pushing the switch in the opposite direction will stop window travel partway.

Lock switch



Press the switch down to lock passenger window switches.

Use this switch to prevent children from accidentally opening or closing a passenger window.

■ The power windows can be operated when

The "ENGINE START STOP" switch is in IGNITION ON mode.

■ Door lock linked window operation

- The power windows can be opened and closed using the wireless remote control or mechanical key. (→P. 47, 534)

- The power windows can be closed using the entry function. (→P. 34)

■ Operating the power windows after turning the "ENGINE START STOP" switch OFF

The power windows can be operated for approximately 45 seconds even after the "ENGINE START STOP" switch is switched to ACCESSORY mode or turned OFF. They cannot, however, be operated once either front door is opened.

■ Jam protection function

If an object becomes caught between the window and the window frame, window travel is stopped and the window is opened slightly.

■ Customization

Settings (e.g. linked door lock operation) can be changed. (→P. 556)

CAUTION

■ Closing the windows

Observe the following precautions.

Failing to do so may result in death or serious injury.

- Check to make sure that all passengers do not have any part of their body in a position where it could be caught when a window is being operated.

- Do not allow children to operate the power windows.

Closing a power window on someone can cause serious injury, and in some instances, even death.

■ Jam protection function

- Never use any part of your body to intentionally activate the jam protection function.

- The jam protection function may not work if something gets caught just before the window fully closes.

1-4. Opening and closing the windows and moon roof

Moon roof (if equipped)

Use the overhead switches to open, close, and tilt the moon roof up and down.

■ Opening and closing



1 Open

The moon roof stops slightly before the fully open position to reduce wind noise. Press the switch again to fully open.

2 Close

Lightly press either of the moon roof switches to stop the moon roof partway.

■ Tilting up and down



1 Tilt up

2 Tilt down

Lightly press either of the moon roof switches to stop the moon roof partway.

■ The moon roof can be operated when

The “ENGINE START STOP” switch is in IGNITION ON mode.

■ Moon roof open warning buzzer

The buzzer sounds and a message is shown on the multi-information display in the instrument panel when the “ENGINE START STOP” switch is turned OFF and the driver’s door is opened with the moon roof open.

■ Door lock linked moon roof operation

- The moon roof can be opened and closed using the wireless remote control or mechanical key. (→P. 47, 534)
- The moon roof can be closed using the entry function. (→P. 34)

■ Operating the moon roof after turning the “ENGINE START STOP” switch OFF

The moon roof can be operated for approximately 45 seconds even after the “ENGINE START STOP” switch is switched to ACCESSORY mode or turned OFF. It cannot, however, be operated once either front door is opened.

■ Jam protection function

If an object is detected between the moon roof and the frame while closing or tilting down, travel is stopped and the moon roof opens slightly.

■ When the moon roof does not close normally

Pressing and holding the CLOSE switch will close the moon roof.

■ Sunshade

The sunshade can be opened and closed manually. However, the sunshade will open automatically when the moon roof is opened.

■ Customization

Setting (e.g. linked door lock operation) can be changed. (→P. 556)

 **CAUTION****■ Opening the moon roof**

Observe the following precautions.

Failing to do so may cause death or serious injury.

- Do not allow any passengers to put their hands or heads outside the vehicle while it is moving.
- Do not sit on top of the moon roof.

■ Closing the moon roof

Observe the following precautions.

Failing to do so may result in death or serious injury.

- Check to make sure that all passengers do not have any part of their bodies in a position where they could be caught when the moon roof is being operated.
- Do not allow children to operate the moon roof.
Closing the moon roof on someone can cause death or serious injury.

■ Jam protection function

- Never use any part of your body to intentionally activate the jam protection function.
- The jam protection function may not work if something gets caught just before the moon roof fully closes.

1-5. Refueling

Opening the fuel tank cap

Perform the following steps to open the fuel tank cap.

■ Before refueling the vehicle

Close all the doors and windows, and turn the “ENGINE START STOP” switch OFF.

■ Opening the fuel tank cap



Press the opener switch.



Turn the fuel tank cap slowly to open.



Hang the fuel tank cap on the back of the fuel filler door.

Closing the fuel tank cap



When replacing the fuel tank cap, turn it until a clicking sound is heard.

After releasing your hand, the cap will turn slightly to the opposite direction.

1

Before driving

■ Fuel types

Unleaded gasoline, Research Octane Number 95 or higher

■ Fuel tank capacity

Approximately 84 L (22.1 gal., 18.4 Imp. gal.)

■ When the fuel filler door opener is inoperable

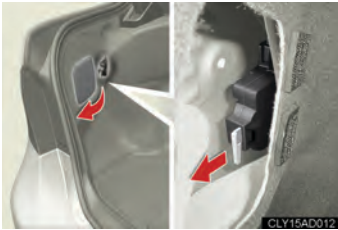

The lever can be used to open the fuel filler door if the fuel filler door cannot be opened using the inside switch.

 **CAUTION**
■ Refueling the vehicle

Observe the following precautions while refueling the vehicle. Failure to do so, may result in death or serious injury.

- After exiting the vehicle and before opening the fuel door, touch an unpainted metal surface to discharge any static electricity. It is important to discharge static electricity before refueling because sparks resulting from static electricity can cause fuel vapors to ignite while refueling.
- Always hold the grips on the fuel tank cap and turn it slowly to remove it. A whooshing sound may be heard when the fuel tank cap is loosened. Wait until the sound cannot be heard before fully removing the cap. In hot weather, pressurized fuel may spray out of the filler neck and cause injury.
- Do not allow anyone that has not discharged static electricity from their bodies to come close to an open fuel tank.
- Do not inhale vaporized fuel. Fuel contains substances that are harmful if inhaled.
- Do not smoke while refueling the vehicle. Doing so may cause the fuel to ignite and cause a fire.
- Do not return to the vehicle or touch any person or object that is statically charged. This may cause static electricity to build up, resulting in a possible ignition hazard.

■ When replacing the fuel cap

Do not use anything but a genuine Lexus fuel tank cap designed for your vehicle. Doing so may cause a fire or other incident which may result in death or serious injury.

 **NOTICE**
■ Refueling

Do not spill fuel during refueling. Doing so may damage the vehicle, such as causing the emission control system to operate abnormally or damaging fuel system components or the vehicle's painted surface.

1-6. Theft deterrent system

Engine immobilizer system

The vehicle's keys have built-in transponder chips that prevent the engine from starting if the key has not been previously registered in the vehicle's on-board computer.



The indicator light flashes after the “ENGINE START STOP” switch has been turned OFF to indicate that the system is operating.

1

Before driving

■ Conditions affecting operation

Depending on surrounding environment and conditions, the engine immobilizer system may not operate properly. This may prevent the engine from starting.
(→P. 37)

■ Certification for the engine immobilizer system

Este equipamento está homologado pela ANATEL de acordo com os procedimentos regulamentados pela Resolução 242/2000 e atende aos requisitos técnicos aplicados.

Este equipamento opera em caráter secundário, isto é, não tem direito a proteção contra interferência prejudicial, mesmo de estações do mesmo tipo, e não pode causar interferência a sistemas operando em caráter primário.



⚠ NOTICE

■ To prevent damage to the key

Do not modify, remove or disable the engine immobilizer system. If any unauthorized changes or modifications are made, the proper operation of the system cannot be guaranteed.

Alarm

The system sounds the alarm and flashes lights when forcible entry is detected.

■ Triggering of the alarm

The alarm is triggered in the following situations.

- A locked door or trunk is unlocked or opened in any way other than using the entry function, wireless remote control or key. (The doors will lock again automatically.)
- The hood is opened while the vehicle is locked.

■ Setting the alarm system

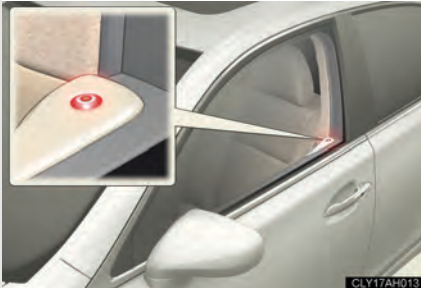

Close the doors, trunk and hood, and lock all doors.

The system will be set automatically after 30 seconds.

The indicator light changes from being on to flashing when the system is set.

■ Deactivating or stopping the alarm

Do one of the following to deactivate or stop the alarm.

- Unlock the doors or trunk.
- Start the engine. (The alarm will be deactivated or stopped after a few seconds.)

■ Items to check before locking the vehicle

To prevent unexpected triggering of the alarm and vehicle theft, make sure of the following.

- Nobody is in the vehicle.
- The windows and moon roof are closed before the alarm is set.
- No valuables or other personal items are left in the vehicle.

■ Triggering of the alarm

The alarm may be triggered in the following situations. (Stopping the alarm deactivates the alarm system.)

- A person inside the vehicle opens a door, the trunk or hood.
- The battery is recharged or replaced when the vehicle is locked.

■ Panic mode



When  is pressed for longer than about one second, an alarm will sound for about 30 seconds and the vehicle lights will flash to deter any person from trying to break into or damage your vehicle.

To stop the alarm, press any button on the wireless remote control.

Correct driving posture

Drive in a good posture as follows:



- 1 Sit upright and well back in the seat. (→P. 59)
- 2 Adjust the position of the seat forward or backward to ensure the pedals can be reached and easily depressed to the extent required. (→P. 59)
- 3 Adjust the seatback so that the controls are easily operable.
- 4 Adjust the tilt and telescopic positions of the steering wheel downward so the SRS airbag is facing your chest. (→ P. 84)
- 5 Adjust the head restraint in place with the center of the head restraint closest to the top of your ears. (→P. 76)
- 6 Wear the seat belt correctly. (→P. 78)

 **CAUTION**

■ **While driving**

- Do not adjust the position of the driver's seat while driving.
Doing so could cause the driver to lose control of the vehicle.
- Do not place a cushion between the driver or passenger and the seatback.
A cushion may prevent correct posture from being achieved, and reduce the effectiveness of the seat belt and head restraint, increasing the risk of death or serious injury to the driver or passenger.
- Do not place anything under the front seats.
Objects placed under the front seats may become jammed in the seat tracks and stop the seat from locking in place. This may lead to an accident. The adjustment mechanism may also be damaged.

■ **Adjusting the seat position**

- Take care when adjusting the seat position to ensure that other passengers are not injured by the moving seat.
- Do not put your hands under the seat or near the moving parts to avoid injury.
Fingers or hands may become jammed in the seat mechanism.

1-7. Safety information

SRS airbags

The SRS airbags inflate when the vehicle is subjected to certain types of severe impacts that may cause significant injury to the occupants. They work together with the seat belts to help reduce the risk of death or serious injury.

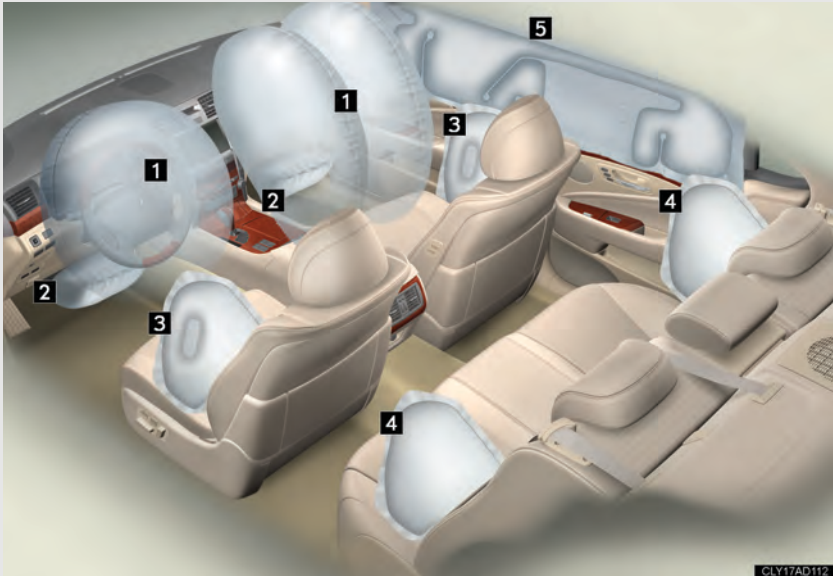

► SRS front airbags

1 SRS driver airbag/front passenger airbag

Can help protect the head and chest of the driver and front passenger from impact with interior components.

2 SRS knee airbags

Can help protect the knees of the driver and front passenger.

► Side and curtain shield airbags

3 Front SRS side airbags

Can help protect the torso of the front seat occupants.

- 4 Rear SRS side airbags
Can help protect the torso of outside rear seats occupants.
- 5 SRS curtain shield airbags
Can help protect primarily the head of outside occupants.

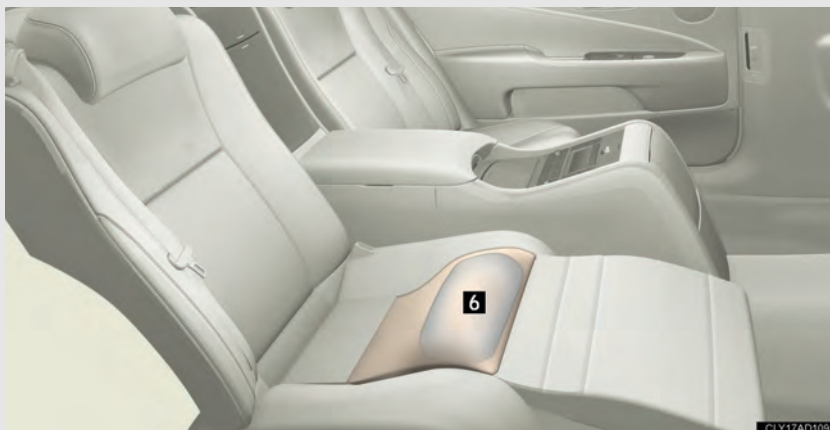

- 6 SRS seat cushion airbags (with relaxation seat only)
Can help restrain the relaxation seat occupant.

Airbag system components

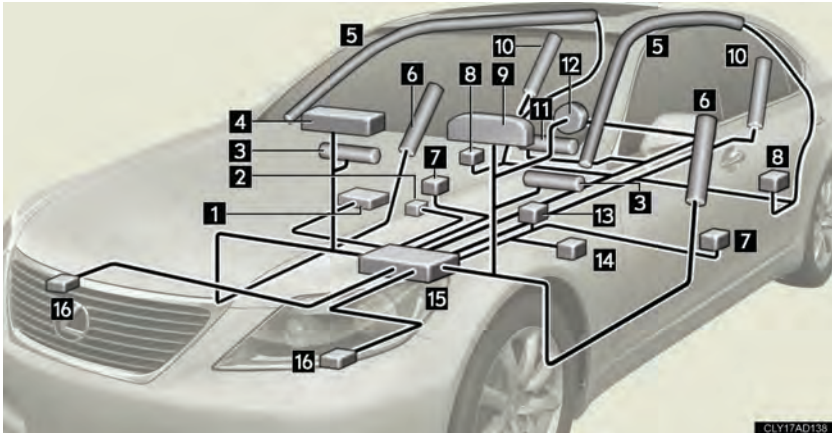

- | | |
|---|-------------------------------------|
| 1 Occupant detection sensor | 9 SRS warning light |
| 2 Front passenger's seat belt buckle switch | 10 Rear side airbags |
| 3 Knee airbags | 11 Seat cushion airbag |
| 4 Front passenger airbag | 12 Driver airbag |
| 5 Curtain shield airbags | 13 Driver's seat belt buckle switch |
| 6 Front side airbags | 14 Driver's seat position sensor |
| 7 Side and curtain shield airbag sensors | 15 Airbag sensor assembly |
| 8 Curtain shield airbag sensors | 16 Front airbag sensors |

The main SRS airbag system components are shown above. The SRS airbag system is controlled by the airbag sensor assembly. The airbag sensor assembly consists of a safing sensor and an airbag sensor.

In certain types of severe frontal or side impacts, the SRS airbag system triggers the airbag inflators. A chemical reaction in the inflators quickly fills the airbags with non-toxic gas to help restrain the motion of the occupants.

■ If the SRS airbags deploy (inflate)

- Bruising and slight abrasions may result from contact with a deploying (inflating) SRS airbag.
- A loud noise and white powder will be emitted.
- Parts of the airbag module (steering wheel hub, airbag cover and inflator) as well as the seats, and parts of the front pillar and roof side rail, may be hot for several minutes. The airbag itself may also be hot.
- The front windshield may crack.

■ Operating conditions (front airbags and seat cushion airbag)

- The SRS front airbags and seat cushion airbag will deploy if the severity of the frontal impact is above the designed threshold level, comparable to an approximate 30 km/h (18 mph) collision when the vehicle impacts straight into a fixed barrier that does not move or deform.

However, this threshold velocity will be considerably higher if the vehicle strikes an object, such as a parked vehicle or sign pole, which can move or deform on impact, or if the vehicle is involved in an underride collision (e.g. a collision in which the front of the vehicle “underrides”, or goes under, the bed of a truck, etc.).

- It is possible that in some collisions where the forward deceleration of the vehicle is very close to the designed threshold level, the SRS front airbags, seat cushion airbag and the seat belt pretensioners may not activate together.
- The SRS front passenger airbag will not activate, if there is no passenger sitting in the front passenger seat. However, the front passenger airbag may deploy, if luggage is put in the seat or the seat belt is buckled up, regardless of the presence of an occupant in the seat.

■ Conditions under which the SRS airbags may deploy (inflate), other than a collision (SRS front airbag and SRS seat cushion airbag)

The SRS front airbags and SRS seat cushion airbag may also deploy if a serious impact occurs to the underside of your vehicle. Some examples are shown in the illustration.

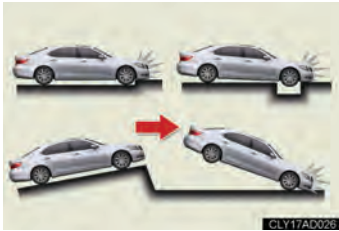

- Hitting a curb, edge of pavement or hard surface
- Falling into or jumping over a deep hole
- Landing hard or vehicle falling

■ Operating conditions (side and curtain shield airbags)

- The SRS front side airbags and curtain shield airbags are designed to inflate when the passenger compartment is subjected to certain types of severe impacts from the side.
- The SRS front side airbag on the passenger seat will not activate if there is no passenger sitting in the front passenger seat. However, the front side airbag on the passenger seat may deploy, if luggage is put in the seat or the seat belt is buckled up, regardless of the presence of an occupant in the seat.

■ Types of collisions that may not deploy the SRS airbag (front airbags and seat cushion airbag)

The SRS front airbags and seat cushion airbag are generally not designed to inflate if the vehicle is involved in a side or rear collision, if it rolls over, or if it is involved in a low-speed frontal collision. But, whenever a collision of any type causes sufficient forward deceleration of the vehicle, deployment of the SRS front airbags and seat cushion airbag may occur.

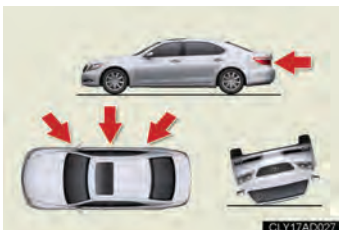

- Collision from the side
- Collision from the rear
- Vehicle rollover

■ Types of collisions that may not deploy the SRS airbag (side and curtain shield airbags)

The SRS side airbag and curtain shield airbag system may not activate if the vehicle is subjected to a collision from the side at certain angles, or a collision to the side of the vehicle body other than the passenger compartment.



- Collision from the side to the vehicle body other than the passenger compartment
- Collision from the side at an angle

The SRS side airbags and curtain shield airbags are not generally designed to inflate if the vehicle is involved in a frontal or rear collision, if it rolls over, or if it is involved in a low-speed side collision.



- Collision from the front
- Collision from the rear
- Vehicle rollover

■ When to contact your Lexus dealer

In the following cases, contact your Lexus dealer, as soon as possible. Do not disconnect the battery cables before contacting them.

- Any of the SRS airbags has been inflated.

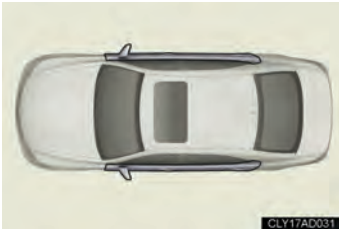
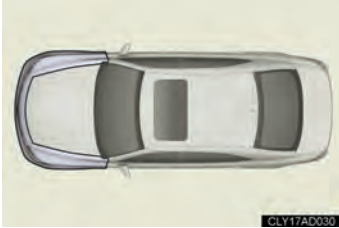

- The front of the vehicle is damaged or deformed, or was involved in an accident that was not severe enough to cause the SRS airbags to inflate.
- A portion of the doors is damaged or deformed, or the vehicle was involved in an accident that was not severe enough to cause the SRS side airbags and curtain shield airbags to inflate.
- The pad section of the steering wheel, dashboard near the front passenger airbag or lower portion of the instrument panel is scratched, cracked, or otherwise damaged.
- Relaxation seat: The seat cushion surface is scratched, cracked, or otherwise damaged.



- The surface of the seats with the side airbag is scratched, cracked, or otherwise damaged.
- The portion of the front pillars, rear pillars or roof side rail garnishes (padding) containing the curtain shield airbags inside is scratched, cracked, or otherwise damaged.

CAUTION

■ SRS airbag precautions

Observe the following precautions regarding the airbags. Failure to do so may cause death or serious injury.

- The driver and all passengers in the vehicle must wear their seat belts properly. The SRS airbags are supplemental devices to be used with the seat belts.
- The SRS driver airbag deploys with considerable force, and can cause death or serious injury especially if the driver is very close to the airbag.

Since the risk zone for driver airbag is the first 50 - 75 mm (2 - 3 in.) of inflation, placing yourself 250 mm (10 in.) from your driver airbag provides you with a clear margin of safety. This distance is measured from the center of the steering wheel to your breastbone. If you sit less than 250 mm (10 in.) away now, you can change your driving position in several ways:

- Move your seat to the rear as far as you can while still reaching the pedals comfortably.
- Slightly recline the back of the seat. Although vehicle designs vary, many drivers can achieve the 250 mm (10 in.) distance, even with the driver seat all the way forward, simply by reclining the back of the seat somewhat. If reclining the back of your seat makes it hard to see the road, raise yourself by using a firm, non-slippery cushion, or raise the seat if your vehicle has that feature.
- If your steering wheel is adjustable, tilt it downward. This points the airbag toward your chest instead of your head and neck.

The seat should be adjusted as recommended above, while still maintaining control of the foot pedals, steering wheel, and your view of the instrument panel controls.

⚠ CAUTION

■ SRS airbag precautions

- The SRS front passenger airbag also deploys with considerable force, and can cause death or serious injury especially if the front passenger is very close to the airbag. The front passenger seat should be as far from the airbag as possible with the seatback adjusted, so the front passenger sits upright.
- Improperly seated and/or restrained infants and children can be killed or seriously injured by a deploying airbag. An infant or child who is too small to use a seat belt should be properly secured using a child restraint system. Lexus strongly recommends that all infants and children be placed in the rear seats of the vehicle and properly restrained. The rear seats are the safest for infants and children. (→P.115)



- Do not sit on the edge of the seat or lean against the dashboard.



- Do not allow a child to sit on the knees of a front passenger while the vehicle is moving.
- Do not drive the vehicle while the driver or passenger have items resting on their knees.

 CAUTION

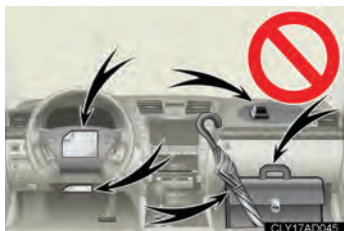
 SRS airbag precautions

- Do not lean against the door, the roof side rail or the front, side and rear pillars.
- Do not allow anyone to kneel on the passenger seats toward the door or put their head or hands outside the vehicle.
- Do not attach anything to or lean anything against areas such as the dashboard, steering wheel pad or lower portion of the instrument panel. These items can become projectiles when SRS driver, front passenger and knee airbags deploy.
- Do not attach anything to areas such as the door, windshield glass, side door glass, front and rear pillars, roof side rail or assist grip.
- Do not hang coat hangers or other hard objects on the coat hooks. All of these items could become projectiles and seriously injure or kill you, should the SRS curtain shield airbag deploy.

 **CAUTION****■ SRS airbag precautions**

- If the vinyl cover is put on the area where the SRS knee airbag will deploy, be sure to remove it.
- Do not use seat accessories which cover the parts where the SRS side airbags and seat cushion airbag inflate as they may interfere with inflation of the airbags.
- Do not strike or apply significant levels of force to the area of the SRS airbag components shown on P. 105.
Doing so can cause the SRS airbags to malfunction.
- Do not touch any of the component parts immediately after the SRS airbags have deployed (inflated) as they may be hot.
- If breathing becomes difficult after the SRS airbag has deployed, open a door or window to allow fresh air in, or leave the vehicle if it is safe to do so. Wash off any residue as soon as possible to prevent skin irritation.
- If the areas where the SRS airbags are stored, such as the steering wheel pad and front pillar garnish, are damaged or cracked, have them replaced by your Lexus dealer.
- Do not place anything, such as a cushion, on the front passenger's seat. Doing so will disperse the passenger's weight, which prevents the sensor from detecting the passenger's weight properly. As a result, the front passenger airbag may not deploy in the event of a collision.

 **CAUTION**

■ **Modification and disposal of SRS airbag system components**

Do not dispose of your vehicle or perform any of the following modifications without consulting your Lexus dealer.

The SRS airbags may malfunction or deploy (inflate) accidentally, causing death or serious injury.

- Installation, removal, disassembly and repair of the SRS airbags.
- Repairs, modifications, removal or replacement of the steering wheel, instrument panel, dashboard, seats or seat upholstery, front, side and rear pillars or roof side rail.
- Repairs or modifications of the front fender, front bumper, or side of the occupant compartment.
- Installation of snow plows, winches, etc. to the front grille (bull bars, kangaroo bar, etc.).
- Modifications to the vehicle's suspension system.
- Installation of electronic devices such as mobile two-way radios or CD players.

Child restraint systems

Lexus strongly urges the use of child restraint systems.

Points to remember

Studies have shown that installing a child restraint on a rear seat is much safer than installing one to the front passenger seat.

- Choose a child restraint system appropriate to the age and size of the child.
- For installation details, follow the instructions provided with the child restraint system.
General installation instructions are provided in this manual. (→P. 119)

Types of child restraints

Child restraint systems are classified into the following 3 types according to the age and size of the child.

▶ Baby seat (Infant seat)

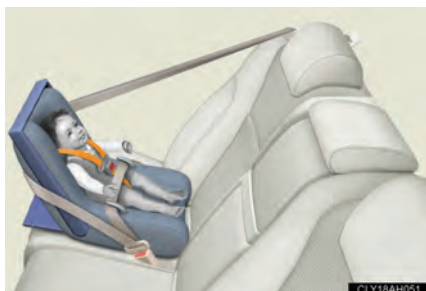

▶ Child seat (Convertible seat)



▶ Junior seat (Booster seat)



■ When installing the child restraint system on the rear outboard seats

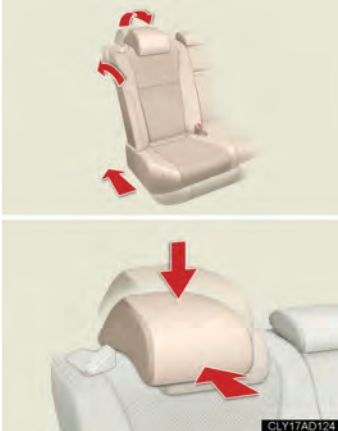

When using child restraint system(s) in the rear outboard seats, adjust the following:

- The upper seatback to the rearmost position
- 4-seat models: The seatback to the most upright position
- The seat cushion to the fully rearward position
- The head restraint to the lowest and rear-most position

■ When the child restraint system is not in use

Leave the child restraint system properly secured on the seat. Do not store the restraint loosely on a passenger seat or in the trunk.

■ Selecting an appropriate child restraint system

Get an appropriate child restraint system for the child. If the child is too large for a child restraint system, sit the child on a rear seat and use the vehicle's seat belt. (→P. 78)

⚠ CAUTION

■ Child restraint precautions

- For effective protection in automobile accidents and sudden stops, a child must be properly restrained, using a seat belt or child restraint system depending on the age and size of the child. Holding a child in your arms is not a substitute for a child restraint system. In an accident, the child can be crushed against the windshield, or between you and the vehicle's interior.
- Lexus strongly urges the use of a proper child restraint system that conforms to the size of the child, installed on the rear seat. According to accident statistics, the child is safer when properly restrained in the rear seat than in the front seat.

 **CAUTION**

■ Child restraint precautions

- Never install a rear-facing child restraint system on the front passenger seat. In the event of an accident, the force of the rapid inflation of the front passenger airbag can cause death or serious injury to the child if the rear-facing child restraint system is installed on the front passenger seat.
- A forward-facing child restraint system should be allowed to be installed on the front passenger seat only when it is unavoidable. Always move the seat as far back as possible, because the front passenger airbag could inflate with considerable speed and force. Otherwise, the child may be killed or seriously injured.
- Do not allow the child to lean his/her head or any part of his/her body against the door or the area of the seat, front pillar or roof side rail from which the side airbags or curtain shield airbags deploy even if the child is seated in the child restraint system. It is dangerous if the side airbags and curtain shield airbags inflate, and the impact could cause death or serious injury to the child.
- Make sure you have complied with all installation instructions provided by the child restraint manufacturer and that the system is properly secured. If it is not secured properly, it may cause death or serious injury to the child in the event of a sudden stop or accident.

Installing child restraints

Follow the child restraint system manufacturer's instructions. Firmly secure child restraints to the outside rear seats using a seat belt or a ISO-FIX rigid anchor. Attach the top strap when installing a child restraint.

1



1 Seat belts equipped with a child restraint locking mechanism (ALR/ELR belts on the rear seats)

2

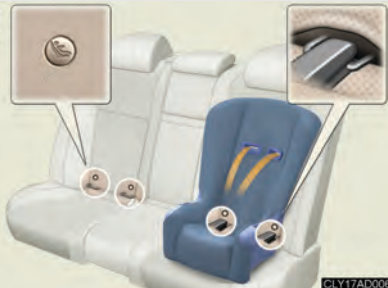

2 ISOFIX rigid anchor (ISOFIX child restraint system)

These exclusive fixing bars are provided for the rear outside seats. (Buttons displaying the location of the anchors are attached to the seats.)

3



3 Anchor bracket (for top strap)

Anchor brackets are provided for each rear seat.

Installing child restraints using a seat belt (child restraint lock function belt)

■ Rear-facing — Baby (infant) seat/child (convertible) seat

STEP 1



Place the child restraint system on the rear seat facing the rear of the vehicle.

STEP 2

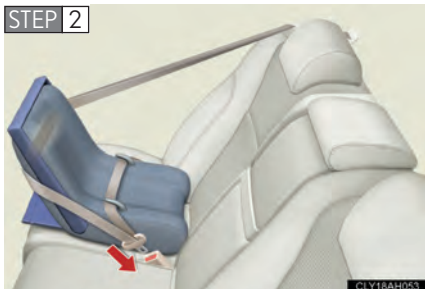

Run the seat belt through the child restraint system and insert the plate into the buckle. Make sure that the belt is not twisted.

■ Forward-facing — Child seat (convertible seat)

STEP 1



Place the child restraint system on the seat facing the front of the vehicle.

STEP 2



Run the seat belt through the child restraint system and insert the plate into the buckle. Make sure that the belt is not twisted.

STEP 3



Fully extend the shoulder belt and allow it to retract to put it in lock mode. In lock mode, the belt cannot be extended.

STEP 4



While pushing the child restraint system into the rear seat, allow the shoulder belt to retract until the child restraint system is securely in place.

After the shoulder belt has retracted to a point where there is no slack in the belt, pull the belt to check that it cannot be extended.

1

Before driving

■ Junior seat (booster seat)

STEP 1



Place the child restraint system on the seat facing the front of the vehicle.

STEP 2



Sit the child in the child restraint system. Fit the seat belt to the child restraint system according to the manufacturer's instructions and insert the plate into the buckle. Make sure that the belt is not twisted.

Check that the shoulder belt is correctly positioned over the child's shoulder, and that the lap belt is as low as possible. (→P. 78)

Removing a child restraint installed with a seat belt



Push the buckle release button and fully retract the seat belt.

Installation with ISOFIX rigid anchor (ISOFIX child restraint system)

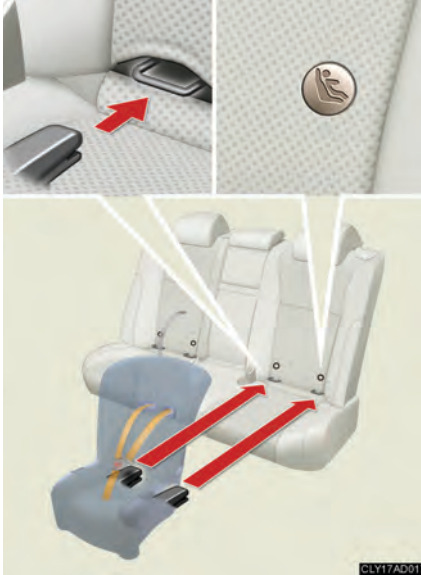

STEP 1 Widen the gap between the seat cushion and seatback slightly.

STEP 2 Latch the buckles onto the exclusive fixing bars.

If the child restraint has a top strap, the top strap should be latched onto the anchor.

1

Before driving

Child restraint systems with a top strap



STEP 1

Secure the child restraint using a seat belt or ISOFIX rigid anchors and move the head restraint in place at the lowest position. (→P. 76)



Open the anchor bracket cover, latch the hook onto the anchor bracket and tighten the top strap.

Make sure the top strap is securely latched.

■ When installing a child restraint system in the front passenger's seat

You need a locking clip to install the child restraint system in the front seat. Follow the instructions provided by the manufacturer of the system. If your child restraint system does not provide a locking clip, you can purchase the following item from your Lexus dealer.

Locking clip for child restraint system
(Part No. 73119-22010)

! CAUTION

■ When installing a junior (booster) seat

To prevent the belt from going into ALR lock mode, do not fully extend the shoulder belt. (→P. 80)

- ALR mode causes the belt to tighten only which could cause injury or discomfort to the child.
- Do not allow the child to play with the seat belt or the child could be killed or seriously injured.

⚠ CAUTION

■ When installing a child restraint system

Follow the directions given in the child restraint system installation manual and fix the child restraint system securely in place.

If the child restraint system is not correctly fixed in place, the child may be injured or even killed in the event of sudden braking or an accident.



- If the driver's seat interferes with the child restraint system and prevents it from being attached correctly, attach the child restraint system to the right-hand rear seat.
- Only put a forward-facing child restraint system on the front seat when unavoidable. When installing a forward-facing child restraint on the front passenger seat, move the seat as far back as possible. Failure to do so may result in death or serious injury if the airbags deploy (inflate).
- Never use a rear-facing child restraint system on the front passenger seat. The force of the rapid inflation of the front passenger airbag can cause death or serious injury to children in the event of an accident.
- A warning label on the passenger side instrument panel reminds you not to install a rear-facing child restraint system on the front passenger seat.

 **CAUTION**

■ **When installing a child restraint system**

- When a junior (booster) seat is installed, always ensure that the shoulder belt is positioned across the center of the child's shoulder. The belt should be kept away from the child's neck, but not so that it could fall off the child's shoulder. Failing to do so may result in death or serious injury in the event of an accident or sudden braking.
- Ensure that the belt and tab are securely locked and the seat belt is not twisted.
- Push and pull the child restraint system in different directions to be sure it is secure.
- Follow all installation instructions provided by the child restraint system manufacturer.

■ **To correctly attach a child restraint system to the anchors**

When using the lower anchors, be sure that there are no foreign objects around the anchors and that the seat belt is not caught behind the child restraint system. Make sure the child restraint system is securely attached, or it may cause death or serious injury to the child in the event of a sudden stop or accident.

2-1. Driving procedures	128	2-4. Using other driving	
Driving the vehicle	128	systems.....	167
Engine (ignition) switch	135	Cruise control	167
Automatic Transmission	139	Lexus parking	
Turn signal lever	143	assist-sensor	171
Parking brake	144	Rear view monitor system	179
Brake Hold.....	147	Driving assist systems	182
2-2. Instrument cluster	149	2-5. Driving information	188
Gauges and meters	149	Cargo and luggage.....	188
Indicators and		Winter driving tips	189
warning lights	152	Trailer towing	192
Multi-information display	155		
2-3. Operating the lights and			
windshield wipers	159		
Headlight switch	159		
Fog light switch	162		
Windshield wipers and			
washer	163		
Headlight cleaner switch	166		

2-1. Driving procedures

Driving the vehicle

The following procedures should be observed to ensure safe driving.

■ Starting the engine (→P. 135)

■ Driving

STEP 1 With the brake pedal depressed, shift the shift lever to D. (→P. 139)

STEP 2 Release the parking brake. (→P. 144)

STEP 3 Gradually release the brake pedal and gently depress the accelerator pedal to accelerate the vehicle.

■ Stopping

STEP 1 With the shift lever in D, depress the brake pedal.

STEP 2 If necessary, set the parking brake.

When the vehicle is stopped for an extended period of time, shift the shift lever to P or N. (→P. 139)

■ Parking the vehicle

STEP 1 With the shift lever in D, depress the brake pedal.

STEP 2 Set the parking brake. (→P. 144)

STEP 3 Shift the shift lever to P. (→P. 139)

STEP 4 Press the “ENGINE START STOP” switch and stop the engine.

STEP 5 Lock the door, making sure that you have the electronic key on your person.

Starting on a steep uphill

STEP 1 Set the parking brake and shift the shift lever to D.

STEP 2 Gently depress the accelerator pedal.

STEP 3 Release the parking brake.

■ Driving in the rain

- Drive carefully when it is raining, because visibility will be reduced, the windows may become fogged-up, and the road will be slippery.
- Drive carefully when it starts to rain, because the road surface will be especially slippery.
- Refrain from high speeds when driving on an expressway in the rain, because there may be a layer of water between the tires and the road surface, preventing the steering and brakes from operating properly.

■ Breaking in your new Lexus

To extend the life of the vehicle, the following precautions are recommended to observe:

- For the first 300 km (186 miles):
Avoid sudden stops.
- For the first 1000 km (621 miles):
 - Do not drive at extremely high speeds.
 - Avoid sudden acceleration.
 - Do not drive continuously in the low range in the “S” position.
 - Do not drive at a constant speed for extended periods.

■ Drum-in-disc type parking brake system

Your vehicle has a drum-in-disc type parking brake system. This type of brake system needs bedding-down of the brake shoes periodically or whenever the parking brake shoes and/or drum are replaced. Have your Lexus dealer perform the bedding down.

■ Operating your vehicle in a foreign country

Comply with the relevant vehicle registration laws and confirm the availability of the correct fuel. (→P. 548)

CAUTION

■ When starting the vehicle

Always keep your foot on the brake pedal while stopped with the engine running. This prevents the vehicle from creeping.

■ When driving the vehicle

- Do not drive if you are unfamiliar with the location of the brake and accelerator pedals to avoid depressing the wrong pedal.
- Accidentally depressing the accelerator pedal instead of the brake pedal will result in sudden acceleration that may lead to an accident that could result in death or serious injury.
- When backing up, you may twist your body around, leading to a difficulty in operating the pedals. Make sure to operate the pedals properly.
- Make sure to keep a correct driving posture even when moving the vehicle only slightly, allowing you to depress the brake and accelerator pedals properly.
- Depress the brake pedal using your right foot. Depressing the brake pedal using your left foot may delay response in an emergency, resulting in an accident.
- Do not drive the vehicle over or stop the vehicle near flammable materials.
- Do not let the vehicle roll backwards while the shift lever is in a driving position, or roll forward while the shift lever is in R.
Doing so may result in an accident or damage to the vehicle.
- If the smell of exhaust is noticed inside the vehicle, open the windows and check that the trunk is closed. Large amounts of exhaust in the vehicle can cause driver drowsiness and an accident, resulting in death or a serious health hazard. Have the vehicle inspected by your Lexus dealer immediately.
- Do not under any circumstances shift the shift lever to P or R while the vehicle is moving.
Doing so can cause significant damage to the transmission system and may result in a loss of vehicle control.
- Do not shift the shift lever to N while the vehicle is moving.
Doing so may cause insufficient engine braking and lead to an accident.
- Do not turn the engine off while driving.
The power steering system will not operate properly if the engine is not running.

 **CAUTION**

- Use engine braking (downshift) to maintain a safe speed when driving down a steep hill.
Using the brakes continuously may cause the brakes to overheat and lose effectiveness. (→P. 139)
 - When stopped on an inclined surface, use the brake pedal and parking brake to prevent the vehicle from rolling backward or forward and causing an accident.
 - Do not adjust the position of the steering wheel, the seat, or the inside or outside rear view mirrors while driving.
Doing so may result in a loss of vehicle control that can cause accidents that may result in death or serious injury.
 - Always check that all passengers' arms, heads or other parts of their bodies are not outside the vehicle, as this may result in death or serious injury.
- **When driving on slippery road surfaces**
- Sudden braking, acceleration and steering may cause tire slippage and reduce your ability to control the vehicle, resulting in an accident.
 - Sudden changes in engine speed, such as engine braking caused by up-shifting or down-shifting, may cause the vehicle to skid, resulting in an accident.
 - After driving through a puddle, lightly depress the brake pedal to make sure that the brakes are functioning properly. Wet brake pads may prevent the brakes from functioning properly. If the brakes on only one side are wet and not functioning properly, steering control may be affected, resulting in an accident.
- **When shifting the shift lever**
- Be careful not to shift the shift lever with the accelerator pedal depressed. This may lead to unexpected rapid acceleration of the vehicle that may cause an accident and result in death or serious injury.

CAUTION

■ When the vehicle is stopped

- Do not race the engine.
If the vehicle is in any gear other than P or N, the vehicle may accelerate suddenly and unexpectedly, and may cause an accident.
- Do not leave the vehicle with the engine running for a long time.
If such a situation cannot be avoided, park the vehicle in an open space and check that exhaust fumes do not enter the vehicle interior.
- Always keep a foot on the brake pedal while the engine is running to prevent an accident caused by the vehicle moving.

■ When the vehicle is parked

- Do not leave glasses, cigarette lighters, spray cans, or soft drink cans in the vehicle when it is in hot areas.
Doing so may result in the following.
 - Gas may leak from a cigarette lighter or spray can, and may lead to a fire.
 - The temperature inside the vehicle may cause the plastic lenses and plastic material of eye glasses to deform or crack.
 - Soft drink cans may fracture, causing the contents to spray over the interior of the vehicle, and may also cause a short circuit in the vehicle's electrical components.
- Always apply the parking brake, shift the shift lever to P, stop the engine and lock the vehicle.
Do not leave the vehicle unattended while the engine is running.
- Do not touch the exhaust pipes and the rear bumper diffusers while the engine is running or immediately after turning the engine off.
Doing so may cause burns.
- Do not leave the engine running in an area with snow build-up, or where it is snowing. If snowbanks build up around the vehicle while the engine is running, exhaust gases may collect and enter the vehicle. This may lead to death or a serious health hazard.

 **CAUTION****■ Exhaust gases**

Exhaust gases include harmful carbon monoxide (CO) that is colorless and odorless. Inhaling exhaust gases may lead to death or a serious health hazard.

- If the vehicle is in a poorly ventilated area, stop the engine. In a closed area, such as a garage, exhaust gases may collect and enter the vehicle. This may lead to death or a serious health hazard.
- The exhaust should be checked occasionally. If there is a hole or crack caused by corrosion, damage to a joint or abnormal exhaust noise, be sure to have the vehicle inspected and repaired by your Lexus dealer. Failure to do so may allow exhaust gases to enter the vehicle, resulting in death or a serious health hazard.

■ When taking a nap in the vehicle

Always turn the engine off. Otherwise, you may accidentally move the shift lever or depress the accelerator pedal, which could cause an accident or fire due to engine overheating. Additionally, if the vehicle is parked in a poorly ventilated area, exhaust gases may collect and enter the vehicle, leading to death or a serious health hazard.

■ When braking the vehicle

- If the electronically controlled brake system does not operate, do not follow other vehicles closely and avoid downhill or sharp turns that require braking. In this case, even though the brakes still operate, the brake pedal should be depressed more firmly than usual. Braking distance also becomes longer.
- The brake system consists of 3 individual hydraulic systems: if one of the systems fails, the others will still operate. In this case, the brake pedal should be depressed more firmly than usual and braking distance becomes longer. If this happens, do not continue to drive the vehicle. If the brake system warning light (red indicator) comes on together with buzzer sound while driving, immediately stop the vehicle in a safe place and contact your Lexus dealer.

 **NOTICE****■ When driving the vehicle**

Do not use the accelerator pedal or depress accelerator and brake pedals at the same time to hold the vehicle on a hill.

NOTICE

■ When parking the vehicle

Always put the shift lever in P.

Failure to do so may cause the vehicle to move or the vehicle may accelerate suddenly if the accelerator pedal is accidentally depressed.

■ Avoiding damage to vehicle parts

- Do not turn the steering wheel fully in either direction and hold it there for a long time.

Doing so may damage the power steering motor.

- When driving over bumps in the road, drive as slowly as possible to avoid damaging the wheels, underside of the vehicle, etc.

■ If you get a flat tire while driving

A flat or damaged tire may cause the following situations. Hold the steering wheel firmly and gradually press the brake pedal to slow down the vehicle.

- It may be difficult to control your vehicle.

- The vehicle will make abnormal sounds.

- The vehicle will behave abnormally.

Replace a flat tire with a new one. (→P. 520)

■ When encountering flooded roads

Do not drive on a road that has flooded after heavy rain etc. Doing so may cause the following serious damage to the vehicle.

- Engine stalling

- Short in electrical components

- Engine damage caused by water immersion

In the event that you drive on a flooded road and the vehicle is flooded, be sure to have your Lexus dealer check the following:

- Brake function

- Changes in quantity and quality of oil and fluid used for the engine, transmission, differential, etc.

- Lubricant condition for the propeller shaft, bearings and suspension joints (where possible) and the function of all joints, bearings, etc.

2-1. Driving procedures

Engine (ignition) switch

Modes can be switched by pressing the “ENGINE START STOP” switch when carrying the electronic key on your person. (The engine can be started in any mode by operating the switch at the same time as depressing the brake pedal.)

■ Starting the engine

STEP 1 Check that the parking brake is set.

STEP 2 Check that the shift lever is set in P.

STEP 3 Sit in the driver’s seat and firmly depress the brake pedal.

The “ENGINE START STOP” switch indicator turns green.

STEP 4

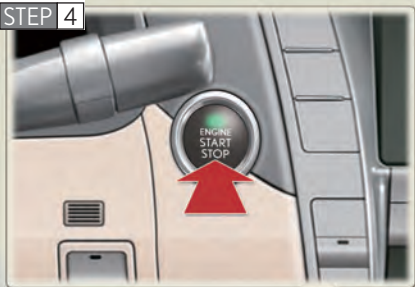

Press the “ENGINE START STOP” switch.

■ Changing “ENGINE START STOP” switch mode

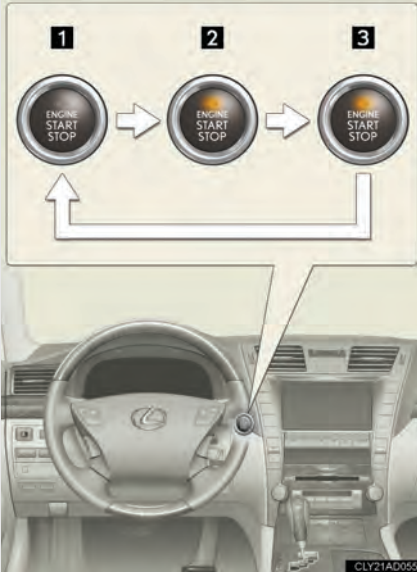

1 OFF *

Emergency flashers can be used.

2 ACCESSORY mode

Some electrical components such as the audio system can be used.

The “ENGINE START STOP” switch indicator turns amber.

3 IGNITION ON mode

All electrical components can be used.

The “ENGINE START STOP” switch indicator turns amber.

*: If the shift lever is in a position other than “P” when turning off the engine, the “ENGINE START STOP” switch will be switched to ACCESSORY mode, not to OFF.

■ If the engine does not start

The engine immobilizer system may not have been deactivated. (→P. 97)

■ When the steering lock cannot be released



The green indicator light on the “ENGINE START STOP” switch will flash and a message will be shown on the multi-information display. Press the “ENGINE START STOP” switch again while turning the steering wheel left and right.

■ When the “ENGINE START STOP” switch indicator flashes in amber

The system may be malfunctioning. Have the vehicle inspected by your Lexus dealer immediately.

■ Auto power off function

If the vehicle is left in ACCESSORY mode for more than an hour with the shift lever in P, the “ENGINE START STOP” switch will automatically turn OFF.

■ Electronic key battery depletion

→P. 40

■ When the electronic key battery is discharged

→P. 475

■ Conditions affecting operation

→P. 37

■ Note for the entry function

→P. 41

CAUTION

■ When starting the engine

Always start the engine while sitting in the driver's seat. Do not depress the accelerator pedal while starting the engine under any circumstances. Doing so may cause an accident resulting in death or serious injury.

■ Caution when driving

Do not touch the "ENGINE START STOP" switch while driving. Pressing and holding the "ENGINE START STOP" switch will stop the engine, which may lead to an unexpected accident.

NOTICE

■ To prevent the battery from being discharged

Do not leave the "ENGINE START STOP" switch in ACCESSORY or IGNITION ON mode for long periods of time without the engine running.

■ When starting the engine

- Do not race a cold engine.
- If the engine becomes difficult to start or stalls frequently, have the engine checked immediately.

2-1. Driving procedures

Automatic Transmission

Select a shift position appropriate for the driving conditions.

■ Shifting the shift lever

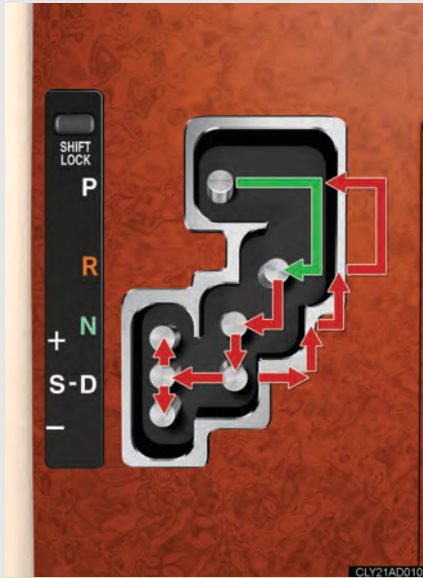

← While the “ENGINE START STOP” switch is in IGNITION ON mode, depress the brake pedal and move the shift lever.

■ Shift position uses

Shift position	Function
P	Parking the vehicle or starting the engine
R	Reversing
N	Neutral
D	Normal driving ^{*1}
S	S mode driving ^{*2} (→P. 140)

^{*1}: To improve fuel consumption and reduce noises, set the shift lever in the D position for normal driving.

^{*2}: Selecting shift ranges using S mode restricts the upper limit of the possible gear ranges, controls engine braking forces, and prevents unnecessary upshifting.

■ Selecting a driving mode

The following patterns can be selected to suit current driving and operating conditions.

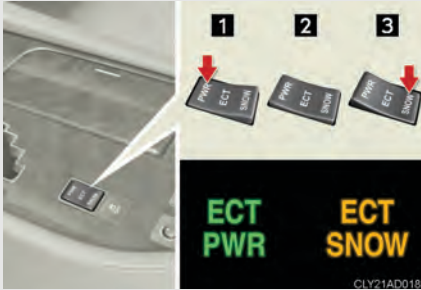

- 1 Power mode**
For powerful acceleration and driving in mountainous regions
- 2 Normal mode**
- 3 Snow mode**
For accelerating and driving on slippery road surfaces, such as on snow
Press SNOW to return to normal mode.

■ Changing shift ranges in S mode

Shift the shift lever to the S position and operate the shift lever.

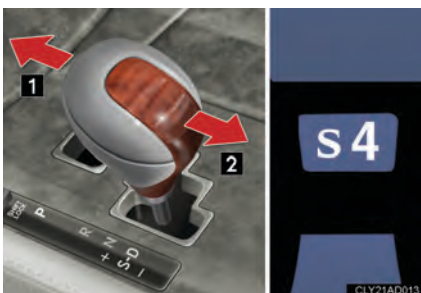

- 1 Upshifting**
- 2 Downshifting**

The initial shift range in S mode is automatically set to 4, 5, 6 or 7 according to vehicle speed. However, the initial shift range may be set to 2 or 3 if the AI-SHIFT has operated while the shift lever was in the D position. (→P.142)

■ Shift ranges and their functions

Shift range	Function
8	Automatically selecting gears between 1 and 8 according to vehicle speed and driving conditions
7	Automatically selecting gears between 1 and 7 according to vehicle speed and driving conditions
6	Automatically selecting gears between 1 and 6 according to vehicle speed and driving conditions
5	Automatically selecting gears between 1 and 5 according to vehicle speed and driving conditions
4	Automatically selecting gears between 1 and 4 according to vehicle speed and driving conditions
3	Automatically selecting gears between 1 and 3 according to vehicle speed and driving condition
2	Automatically selecting gears between 1 and 2 according to vehicle speed and driving conditions
1	Setting the gear at 1

A lower shift range will provide greater engine braking forces than a higher shift range.

■ S mode

- When the shift range is 6 or lower, holding the shift lever toward “+” sets the shift range to 8.
- When the shift range is 6 or higher, moving the shift lever toward “-” may change down by 2 shift ranges or more depending on driving conditions.
- To prevent the engine from over-revving, upshifting may automatically occur.

■ Downshifting restrictions warning buzzer (in the S mode)

To help ensure safety and driving performance, downshifting operation may sometimes be restricted. In some circumstances, downshifting may not be possible even when the shift lever is operated. (The warning buzzer will sound twice.)

■ When driving with the cruise control system

Engine brake will not operate in the S mode, even when downshifting to 7, 6, 5 or 4. (→P.167)

■ Snow mode automatic deactivation

Snow mode is automatically deactivated if the “ENGINE START STOP” switch is turned off after driving in snow mode.

■ If the shift lever cannot be shifted from P

→P. 530

■ AI-SHIFT

The AI-SHIFT automatically shifts the gear to the optimal position according to the driver performance and driving conditions.

The AI-SHIFT automatically operates when the shift lever is in the D position. (Shifting the shift lever to the S position cancels the function.)

2-1. Driving procedures

Turn signal lever



- 1 Right turn
- 2 Left turn
- 3 Move and hold the lever part-way to signal a lane change.
The right hand signal will flash until you release the lever.
- 4 Move and hold the lever part-way to signal a lane change.
The left hand signal will flash until you release the lever.

■ Turn signals can be operated when

The “ENGINE START STOP” switch is in IGNITION ON mode.

■ If the indicators flash faster than usual

Check that a light bulb in the front or rear turn signal lights has not burned out.

2-1. Driving procedures

Parking brake

For the parking brake, an electrical parking brake system is adopted.

■ Manual mode

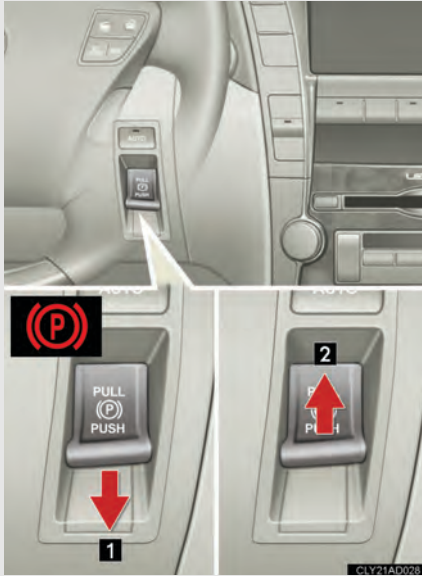

1 Sets the parking brake.

If the parking brake switch is operated when the “ENGINE START STOP” switch is not in IGNITION ON mode, the parking brake indicator light will come on and stay on for a while.

Press and hold the parking brake switch if an emergency occurs and it is necessary to operate the parking brake while driving.

2 Release the parking brake.

Operate the parking brake switch while depressing the brake pedal. Make sure that the parking brake indicator light goes off.

■ Automatic mode



On/off

The parking brake is set automatically according to shift lever operation.

Operate the shift lever with the brake pedal depressed.

- When the shift lever is moved out of P
The parking brake will be released.
- When the shift lever is moved into P
The parking brake will be set.

■ Parking brake operation

- When the “ENGINE START STOP” switch is not in IGNITION ON mode, the parking brake cannot be released using the parking brake switch.
- When the “ENGINE START STOP” switch is not in IGNITION ON mode, automatic mode (automatic brake setting and releasing) is not available.
- If the parking brake is operated repeatedly over a short period of time, the system may restrict operation to prevent overheating. If this happens, refrain from operating the parking brake. Normal operation will return after about 1 minute.

■ Parking brake indicator light

When the “ENGINE START STOP” switch is turned OFF with the parking brake set, the parking brake indicator light will come on and stay on for about 15 seconds. This does not indicate a malfunction.

■ Parking brake operation sound

When the parking brake operates, a motor sound (whirring sound) may be heard. This does not indicate a malfunction.

■ When there is a malfunction in the system

Warning lights and/or warning messages will turn on or flash. (→P. 512, 517)
Depending on the condition, the parking brake indicator light may flash.

NOTICE

■ When parking the vehicle

Before you leave the vehicle, set the parking brake, shift the shift lever to P and make sure that the vehicle does not move.

■ When the system malfunctions

Stop the vehicle in a safe place and check the warning messages.

■ When the parking brake cannot be released due to a malfunction

Use the parking brake release tool to manually release the parking brake.
(→P. 531)

Driving the vehicle with the parking brake set will lead to brake components overheating, which may affect braking performance and increase brake wear.

2-1. Driving procedures

Brake Hold

The brake hold system keeps the brake applied when the shift lever is in D, S or N with the system on and the brake pedal has been depressed to stop the vehicle. The system releases the brake when the accelerator pedal is depressed with the shift lever in D or S to allow smooth start off.



Turns the brake hold system on.

The brake hold standby indicator comes on. While the system is holding the brake, the brake hold operated indicator light comes on.

■ Brake hold system operating conditions

The brake hold system cannot be turned on in the following conditions.

- The trunk or hood is not closed.
- The driver's door is not closed.
- The driver is not wearing the seat belt.

If any of the conditions above are detected when the brake hold system is enabled, the system will turn off and the brake hold operated indicator light will go off. In addition, if any of the conditions are detected while the system is holding the brake, a warning buzzer will sound and a message will be shown on the multi-information display. The parking brake will then be set automatically.

■ Brake hold function

- If the brake pedal is left released for a period of about 3 minutes after the system has started holding the brake, the parking brake will be set automatically. In this case, a warning buzzer sounds and a message is shown on the multi-information display.
- To turn the system off while the system is holding the brake, firmly depress the brake pedal and press the button again.
- The brake hold function may not hold the vehicle when the vehicle is on a steep incline. In this situation, it may be necessary for the driver to apply the brakes. The multi-information display will inform the driver of this situation.

■ When the parking brake is set automatically while the system is holding the brakes

The parking brake will not be released automatically. Release the parking brake by operating the parking brake switch, making sure that the parking brake indicator light goes off. (→P. 144)

■ When there is a malfunction in the system

Warning lights and/or warning messages will turn on or flash. (→P. 512, 517)

CAUTION

■ When stopped on a slippery road

The system cannot stop the vehicle when the gripping ability of the tires has been exceeded. Do not use the system when stopped on a slippery road.

NOTICE

■ When parking the vehicle

The brake hold system is not designed for use when parking the vehicle for a long period of time. Turning the “ENGINE START STOP” switch OFF while the system is holding the brake may release the brake, which would cause the vehicle to move. When operating the “ENGINE START STOP” switch, depress the brake pedal, set the parking brake and shift the shift lever to P.

2-2. Instrument cluster

Gauges and meters



The following gauges, meters and display illuminate when the “ENGINE START STOP” switch is in IGNITION ON mode.

- 1 Tachometer**
Displays the engine speed in revolutions per minute.
- 2 Multi-information display**
→P. 155
- 3 Speedometer**
Displays the vehicle speed.
- 4 Fuel gauge**
Displays the quantity of fuel remaining in the tank.
- 5 Trip meter and trip meter reset buttons**
- 6 Odometer**
Displays the total distance the vehicle has been driven.
- 7 Trip meter**
Displays the distance the vehicle has been driven since the meter was last reset. Trip meters A and B can be used to record and display different distances independently.

- 8 Instrument panel light control buttons
- 9 Engine coolant temperature gauge
Displays the engine coolant temperature.

Trip meter and trip meter reset buttons

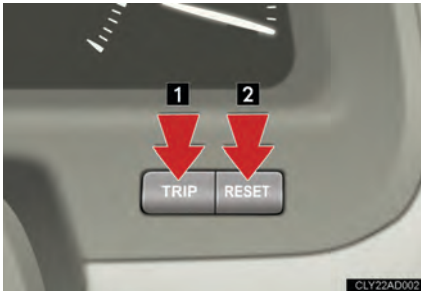

- 1 Changes the display.
- 2 Resets the trip meter currently displayed to "0".

Instrument panel light control buttons

The brightness of the instrument panel lights can be adjusted.

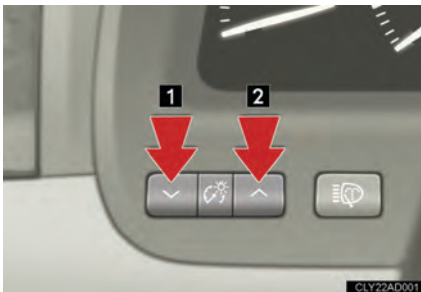

- 1 Darker
- 2 Brighter

 NOTICE**■ To prevent damage to the engine and its components**

- Do not let the indicator needle of the tachometer enter the red zone, which indicates the maximum engine speed.
- The engine may be overheating if the temperature gauge is in the red zone (H). In this case, immediately stop the vehicle in a safe place, check the engine after it has cooled completely. (→P. 541)

2-2. Instrument cluster

Indicators and warning lights

The indicator and warning lights on the instrument cluster and center panel inform the driver of the status of the vehicle's various systems.

► Instrument cluster



► Center panel



■ Indicators

The indicators inform the driver of the operating state of the vehicle's various systems.



Turn signal indicator
(→P. 143)



Headlight high beam indicator (→P. 159)



Tail light indicator
(→P. 159)



Front fog light indicator
(→P. 162)



Rear fog light indicator
(→P. 162)



ECT SNOW indicator
(→P. 140)



ECT PWR indicator
(→P. 140)



Cruise control indicator
(→P. 167)



^{*} AFS OFF indicator
(→P. 160)



^{*} Slip indicator
(→P. 183)



^{*} Brake hold standby indicator (→P. 147)



^{*} Brake hold operated indicator (→P. 147)



Parking brake indicator
(→P. 144)

■ Warning lights

Warning lights inform the driver of malfunctions in any of the vehicle's systems. (→P. 512)



- *: These lights turn on when the “ENGINE START STOP” switch is turned to IGNITION ON mode to indicate that a system check is being performed. They will turn off after the engine is started, or after a few seconds. There may be a malfunction in a system if a light does not come on, or if the lights do not turn off. Have the vehicle inspected by your Lexus dealer, for details.

⚠ CAUTION

■ If a safety system warning light does not come on

Should a safety system light such as ABS and SRS airbag warning light not come on when you start the engine, this could mean that these systems are not available to help protect you in an accident, which could result in death or serious injury. Have the vehicle inspected by your Lexus dealer immediately if this occurs.

Multi-information display

The multi-information display presents the driver with a variety of driving-related data, including the current outside air temperature.



- Trip information (→P. 156)

Displays cruising range, fuel consumption and other cruising-related information.

- Lexus parking assist-sensor display (→P. 171)

Automatically displayed when using Lexus parking assist-sensor.

- Shift position and shift range (→P. 139)

- Warning messages (→P. 517)

Automatically displayed when a malfunction occurs in one of the vehicle's systems.

Trip information

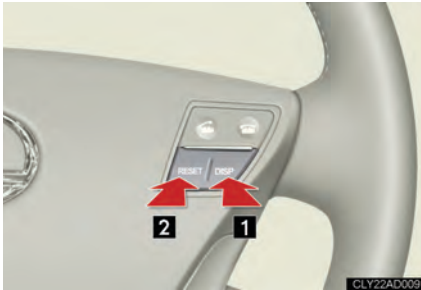

1 DISP switch

Display items can be switched by pressing the DISP switch.

2 RESET switch

■ Outside temperature

Displays the outside air temperature.

The temperature range that can be displayed is from -40°C (-40°F) to 50°C (122°F).

■ Cruising range

Displays the estimated maximum distance that can be driven with the quantity of fuel remaining.

- This distance is computed based on your average fuel consumption. As a result, the actual distance that can be driven may differ from that displayed.
- When only a small amount of fuel is added to the tank, the display may not be updated.

■ Average fuel consumption

Displays the average fuel consumption since the function was reset.

The function can be reset by pressing the RESET switch when the average fuel consumption is displayed.

■ Current fuel consumption

Displays the current rate of fuel consumption.

■ Average fuel consumption after refueling

Displays the average fuel consumption since the vehicle was last refueled.

■ Distance after refueling

Displays the distance the vehicle has been driven since the vehicle was last refueled.

■ Elapsed time

Displays the elapsed time since it was last reset

The function can be reset by pressing the RESET switch when the elapsed time is displayed.

■ Average vehicle speed

Displays the average vehicle speed since the engine was started or the function was reset.

The function can be reset by pressing the RESET switch when the average vehicle speed is displayed.

■ System check display

After switching the “ENGINE START STOP” switch to IGNITION ON mode, SYSTEM CHECK is displayed while system operation is checked. When the system check is complete, the normal screen will return.

■ To turn off the background images on the trip information screen

When information is displayed together with a background image, press the “DISP” switch for 1 second or more.

Pressing the switch again for longer than 1 second turns on the background images.

■ Liquid crystal display

Small spots or light spots may appear on the display. This phenomenon is characteristic of liquid crystal displays, and there is no problem to continue using the display.

■ Customization

Setting of available languages can be changed. (→P. 556)



NOTICE

■ **The multi-information display at low temperatures**

Allow the interior of the vehicle to warm up before using the liquid crystal information display. At extremely low temperatures, the information display monitor may respond slowly, and display changes may be delayed.

2-3. Operating the lights and windshield wipers

Headlight switch

The headlights can be operated manually or automatically.



- The front position, tail, license plate and instrument panel lights turn on.
- ☏ The headlights and all lights listed above turn on.
- AUTO** The headlights and front position lights turn on and off automatically. (When the “ENGINE START STOP” switch is in IGNITION ON mode)

Turning on the high beam headlights

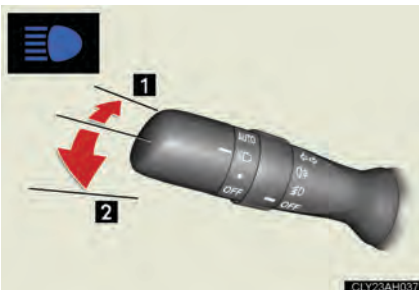

- 1 With the headlights on, push the lever away from you to turn on the high beams.
Pull the lever toward you to the center position to turn the high beams off.
- 2 Pull the lever toward you to turn on the high beams.
Release to turn them off. You can flash the high beams with the headlights on or off.

AFS

AFS (Adaptive Front-lighting System) improves visibility at intersections and on curves by automatically adjusting the direction of light axis of the headlights according to vehicle speed and the degree of the tire angle that are controlled by steering input.

Operates at speeds of 10 km/h (6 mph) or higher.

■ Deactivating AFS

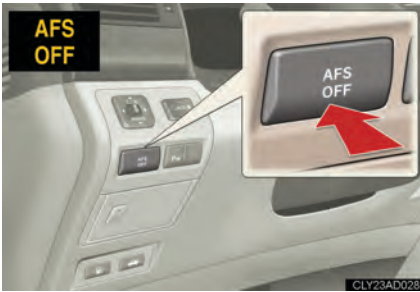

On/off

The indicator turns on when the AFS is deactivated.

■ Headlight control sensor

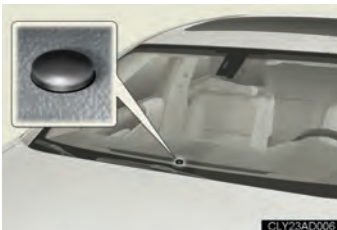

The sensor may not function properly if an object is placed on the sensor, or anything that blocks the sensor is affixed to the windshield.

Doing so interferes with the sensor detecting the level of ambient light and may cause the automatic headlight system to malfunction.

■ Automatic light off system

- When the light switch is in the  position: The headlights turn off automatically if the “ENGINE START STOP” switch is turned to ACCESSORY mode or OFF.
- When the light switch is in the **AUTO** position: The headlights turn off automatically if the “ENGINE START STOP” switch is turned to ACCESSORY mode or OFF and the driver's door is opened.

To turn the lights on again, switch to IGNITION ON mode, or turn the light switch OFF once and then back to the ● or  position.

■ Light reminder buzzer

A buzzer sounds when the “ENGINE START STOP” switch is turned OFF or switched to ACCESSORY mode and the driver's door is opened while the lights are turned on.

■ Automatic headlight leveling system

The level of the headlights is automatically adjusted according to the number of passengers and the loading condition of the vehicle to ensure that the headlights do not interfere with other road users.

■ If the AFS OFF indicator flashes...

It may indicate a malfunction in the system. Contact your Lexus dealer.

■ Customization

Settings (e.g. light sensor sensitivity) can be changed. (→P. 556)

NOTICE

■ To prevent the battery from being discharged

Do not leave the lights on longer than necessary when the engine is not running.

2-3. Operating the lights and windshield wipers

Fog light switch

The fog lights improve visibility in difficult driving conditions, such as in rain or fog. They can be used when the headlights or front position lights are turned on. (The rear fog lights can be used when the front fog lights are turned on.)

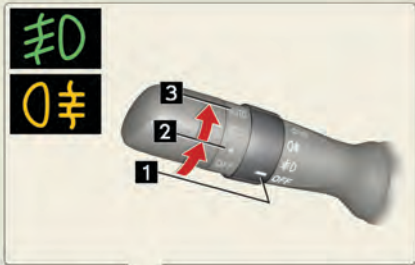

- 1 Off
- 2 Front fog lights on
- 3 Both front and rear fog lights on (Rotating the switch again turns only the rear fog lights off.)

Releasing the switch returns the ring to the  position.



2-3. Operating the lights and windshield wipers

Windshield wipers and washer

With AUTO selected, the wipers will operate automatically when the sensor detects falling rain. The system automatically adjusts wiper timing in accordance with rain volume and vehicle speed.

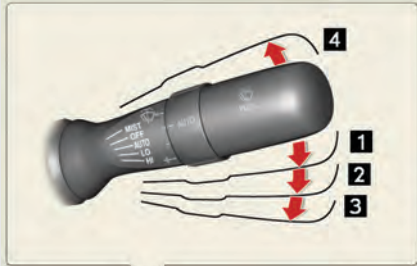

- 1 Rain-sensing wiper operation
- 2 Low speed wiper operation
- 3 High speed wiper operation
- 4 Temporary operation



- 5 Wash/wipe operation

Wipers operate automatically. (After operating several times, the wipers operate one more time after a short delay to prevent dripping.)

If the headlights are on, the headlight cleaner will operate once.

■ The windshield wiper and washer can be operated when

The “ENGINE START STOP” switch is in IGNITION ON mode.

■ Effects of vehicle speed on wiper operation

With the settings other than AUTO also, the time until drop prevention wiper sweep occurs is changes depending on vehicle speed.

With LO selected, wiper operation will be switched from low speed to intermittent wiper operation only when the vehicle is stationary.

(However, the mode cannot be switched when the adjustment dial for the sensor sensitivity is set the lowest position.)

■ AUTO mode

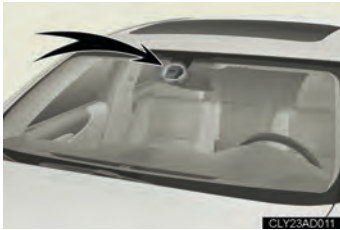

The sensor judges the amount of raindrops.

An optical sensor is adopted. It may not operate properly when sunlight from the rising or setting of the sun intermittently strikes the windshield, or if bugs etc. are present on the windshield.

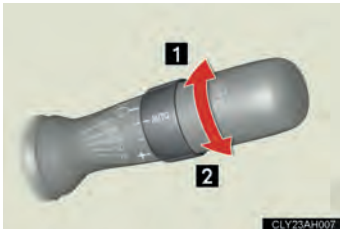

The sensitivity of the sensor can be adjusted by turning the knob.

- 1 Decreases the sensitivity (-)
- 2 Increases the sensitivity (+)

■ If no windshield washer fluid sprays

Check that the washer nozzles are not blocked and if there is washer fluid in the windshield washer fluid reservoir.

 CAUTION**■ Caution regarding the use of windshield wipers in AUTO mode**

The windshield wipers may operate unexpectedly if the sensor is touched or the windshield is subject to vibration in AUTO mode. Take care that your fingers or anything else do not become caught in the windshield wipers.

 NOTICE**■ When the windshield is dry**

Do not use the wipers, as they may damage the windshield.

■ When the no washer fluid tank is empty

Damage to the washer fluid pump may be caused if the lever is pulled toward you and held continually.

2-3. Operating the lights and windshield wipers

Headlight cleaner switch

Washer fluid can be sprayed on the headlights.



Press the switch to clean the headlights.

■ The headlight cleaner can be operated when

When the “ENGINE START STOP” switch is in IGNITION ON mode and the headlight switch is turned on.

■ Windshield washer linked operation

When the windshield washer is operated with the “ENGINE START STOP” switch in IGNITION ON mode and the headlights on, the headlight cleaner will operate once. (→P. 163)

NOTICE

■ When the washer fluid tank is empty

Damage to the washer fluid pump may be caused if the switch is pressed continually.

Cruise control

Use cruise control to maintain a set speed without using the accelerator.



■ Set the vehicle speed



Press the ON-OFF button to activate the cruise control.

Press the button once more to deactivate the cruise control.



Accelerate or decelerate to the desired speed and push the lever down to set the speed.

■ Adjusting the speed setting



- 1 Increase speed.
- 2 Decrease speed.

Hold the lever until the desired speed setting is obtained.

Fine adjustment of the set speed can be made by lightly pushing the lever up or down and releasing it.

■ Canceling and resuming regular acceleration



- 1 Cancel

Push the lever towards you to cancel cruise control.

The speed setting is also canceled when the brakes are applied.

- 2 Resume

To resume cruise control and return to the set speed, push the lever up.

Resuming is available when vehicle speed is approximately 40 km/h (25 mph) or more.

■ Cruise control can be set when

- The shift lever is in D or the 4, 5, 6, 7 or 8 range of S position.
- Vehicle speed is between approximately 40 km/h and 200 km/h (25 mph and 125 mph).

■ Accelerating

The vehicle can be accelerated normally.

■ Automatic cruise control cancellation

The cruise control will stop maintaining the vehicle speed in any of the following situations:

- Actual vehicle speed falls more than 16 km/h (10 mph) below the preset vehicle speed.

At this time, the memorized set speed is not retained.

- Actual vehicle speed is below 40 km/h (25 mph).
- VSC is activated.

■ If the cruise control indicator light flashes

Press the "ON-OFF" button once to deactivate the system, and then press the button again to reactivate the system.

If the cruise control speed cannot be set or if the cruise control cancels immediately after being activated, there may be a malfunction in the cruise control system. Contact your Lexus dealer, and have your Lexus inspected.

 **CAUTION**

■ **To avoid operating the cruise control by mistake**

Keep the ON-OFF button off when not in use.

■ **Situations unsuitable for cruise control**

Do not use cruise control in any of the following situations.

Doing so may result in control of the vehicle being lost and could cause serious or fatal accident.

- In heavy traffic
- On roads with sharp bends
- On slippery roads, such as those covered with rain, ice or snow
- On winding roads
- On steep hills

Vehicle speed may exceed the set speed when driving down a steep hill.

2-4. Using other driving systems

Lexus parking assist-sensor

The distance to obstacles measured by the sensors is communicated via the multi-information display and a buzzer when parallel parking or maneuvering into a garage. Always check the surrounding area when using this system.

■ Types of sensors



- 1 Front side sensors
- 2 Front corner sensors
- 3 Front center sensors
- 4 Rear corner sensors
- 5 Rear center sensors

■ Lexus parking assist-sensor switch



On/off

When on, the indicator light comes on and the buzzer sounds to inform the driver that the system is operational.

Press the button to switch the on/off mode.

Display

When the sensors detect an obstacle, the graphic is shown on the multi-information display and touch screen according to position and distance to the obstacle.

Multi-information display

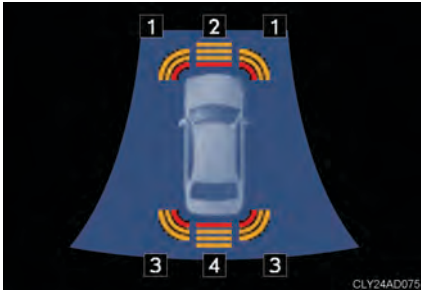

- 1 Front side sensors and front corner sensors operation
- 2 Front center sensors operation
- 3 Rear corner sensors operation
- 4 Rear center sensors operation

Touch screen



When the vehicle is moving forward

The graphic is automatically displayed when an obstacle is detected. The screen can be set so that the graphic is not displayed. (→P.176)







When the vehicle is moving backward

A simplified image is displayed on the right upper corner when an obstacle is detected.



The distance display and buzzer

When a sensor detects an obstacle, the direction of and the approximate distance to the obstacle are displayed and the buzzer sounds.

Center sensors

Level	1	2	3	4
Display example of front center sensor				
Buzzer	Slow	Medium	Fast	Continuous

Corner sensors and side sensors

Level	1	2	3	4
Display example of front right sensor	-			
Buzzer	-	Medium	Fast	Continuous

■ Detection level and approximate distance to an obstacle

Level	1	2	3	4
Front side sensors	-	50 to 37.5 cm (1.5 to 1.1 ft.)	37.5 to 30 cm (1.1 to 1.0 ft.)	30 cm (1.0 ft.) or less
Front corner sensors	-	60 to 37.5 cm (1.8 to 1.1 ft.)	37.5 to 30 cm (1.1 to 1.0 ft.)	30 cm (1.0 ft.) or less
Front center sensors	100 to 50 cm (3.0 to 1.5 ft.)	50 to 37.5 cm (1.5 to 1.1 ft.)	37.5 to 30 cm (1.1 to 1.0 ft.)	30 cm (1.0 ft.) or less
Rear corner sensors	-	60 to 37.5 cm (1.8 to 1.1 ft.)	37.5 to 25 cm (1.1 to 0.8 ft.)	25 cm (0.8 ft.) or less
Rear center sensors	150 to 60 cm (4.5 to 2.0 ft.)	60 to 45 cm (2.0 to 1.4 ft.)	45 to 35 cm (1.4 to 1.1 ft.)	35 cm (1.1 ft.) or less

Sensors that operate and detection range

The following diagrams show the sensor detection range. Note that sensors may not be able to detect obstacles that are extremely close to the vehicle.

Sensors that operate

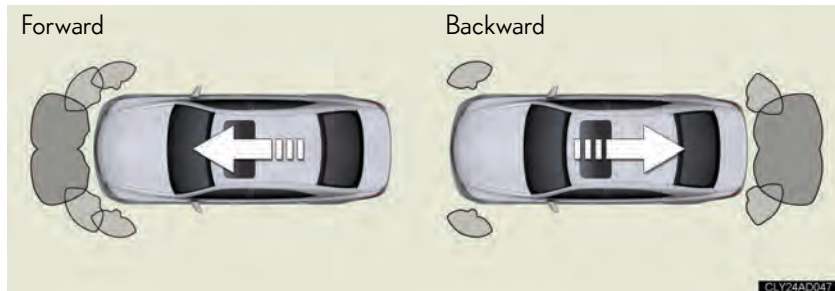

Detection range of the sensors

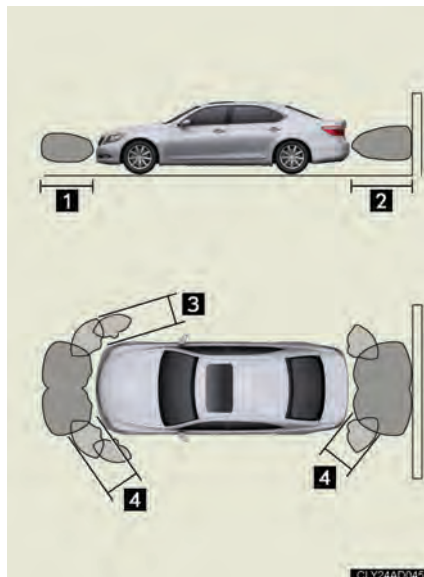

- 1 Approx. 100 cm (3.0 ft.)
- 2 Approx. 150 cm (4.5 ft.)
- 3 Approx. 50 cm (1.5 ft.)
- 4 Approx. 60 cm (2.0 ft.)

The diagram shows the detection range of the sensors. Note that the sensors may not be able to detect obstacles that are extremely close to the vehicle.

The range of the sensors may change depending on the shape of the object etc.



Customization of the Lexus parking assist-sensor

The buzzer volume, display and buzzer timing and display of the graphic on the screen can be customized.

Press  to display the information screen, and touch .



■ Buzzer volume

STEP 1 Touch .

STEP 2 Touch a switch (from  to ) to adjust the buzzer volume, and touch .

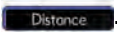
■ Display and buzzer timing

STEP 1 Touch .

STEP 2 Set the display and buzzer timing for the front and the rear center sensors. When  or  is touched, the triangle marks move between green (turns on at level 1) and orange (turns on at level 2) to select the timing.

■ Display of the graphic on the screen when the vehicle is moving forward

Touch . When this switch is touched, display setting switches between on and off.

■ Sensor detection information

- Certain vehicle conditions and the surrounding environment may affect the ability of a sensor to correctly detect an obstacle. Particular instances where this may occur are listed below.
 - There is dirt, snow or ice on a sensor.
 - A sensor is frozen.
 - A sensor is covered in any way.
 - The vehicle is leaning considerably to one side.
 - On an extremely bumpy road, on an incline, on gravel, or on grass.
 - The vicinity of the vehicle is noisy due to vehicle horns, motorcycle engines, air brakes of large vehicles, or other loud noises producing ultrasonic waves.
 - There is another vehicle equipped with parking assist sensors in the vicinity.
 - A sensor is coated with a sheet of spray or heavy rain.
 - The vehicle is equipped with a fender pole or radio antenna.
 - Towing eyelets are installed.
 - A bumper or sensor receives a strong impact.
 - The vehicle is approaching a tall or right-angled curb.
 - In harsh sunlight or intense cold weather.
 - A non-genuine Lexus suspension (lowered suspension, etc.) is installed.

In addition to the examples above, there are instances in which, because of their shapes, signs and other objects may be judged by a sensor to be closer than they are.

- The shape of the obstacle may prevent a sensor from detecting it. Pay particular attention to the following obstacles.
 - Wires, fences, ropes, etc.
 - Cotton, snow and other materials that absorb radio waves
 - Sharply-angled objects
 - Low obstacles
 - Tall obstacles with upper sections projecting outwards in the direction of your vehicle

■ If the display flashes and a message is displayed

→P. 517

CAUTION

■ Caution when using the Lexus parking assist-sensor

Observe the following precautions.

Failing to do so may result in the vehicle being unable to be driven safely and possibly cause an accident.

- Do not use the sensor at speeds in excess of 10 km/h (6 mph).
- Do not attach any accessories within the sensor range.

NOTICE

■ Notes when washing the vehicle

Do not apply intensive bursts of water or steam to the sensor area.
Doing so may result in the sensor malfunctioning.

2-4. Using other driving systems

Rear view monitor system

The rear view monitor system assists the driver by displaying an image of the area behind the vehicle. The image is displayed in reverse on the screen. This reversed image is a similar image to the one on the inside rear view mirror.



The rear view image is displayed when the shift lever is in the R position.

If the shift lever is shifted out of R, the screen returns to the previous one.

2

When driving

■ Displayed area

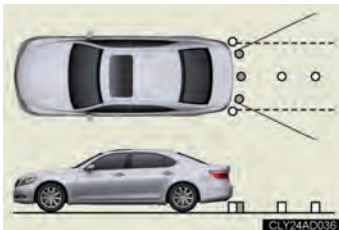

The area covered by the camera is limited. Objects that are close to either corner of the bumper or under the bumper cannot be seen on the screen.

The area displayed on the screen may vary according to vehicle orientation or road conditions.



■ Rear view monitor system camera



In the following cases, it may become difficult to see the images on the screen, even when the system is functioning correctly.

- The vehicle is in a dark area, such as at night.
- The temperature near the lens is extremely high or low.
- Water droplets are on the camera lens or humidity is high, such as when it rains.
- Foreign matter, such as snow or mud, adheres to the camera lens.
- The sun or headlights are shining directly into the camera lens.

■ Smear effect



If a bright light, such as sunlight reflected off the vehicle body, is picked up by the camera, a smear effect* characteristic to the camera may occur.

*: Smear effect — A phenomenon that occurs when a bright light is picked up by the camera; when transmitted by the camera, the light source appears to have a vertical streak above and below it.

 **CAUTION**

- **When using the rear view monitor system, observe the following precautions to avoid an accident that could result in death or serious injuries.**
 - Never depend solely on the monitor system when reversing.
 - Always check visually and with the mirrors to confirm your intended path is clear.
 - Depicted distances between objects and flat surfaces differ from actual distances.
 - Do not use the system if the trunk is open.
- **Conditions which may affect the rear view monitor system**
 - If the back of the vehicle has been hit, the camera's position and mounting angle may have changed. Have the vehicle inspected by your Lexus dealer.
 - Rapid temperature changes, such as when hot water is poured on the vehicle in cold weather, may cause the system to function abnormally.
 - If the camera lens is dirty, it cannot transmit a clear image. Rinse with water and wipe with a soft cloth. If extremely dirty, wash with a mild cleanser and rinse.
 - The displayed image may be darker and moving images may be slightly distorted when the system is cold.

Driving assist systems

To help enhance driving safety and performance, the following systems operate automatically in response to various driving situations. Be aware, however, that these systems are supplementary and should not be relied upon too heavily when operating the vehicle.

■ ABS (Anti-lock Brake System)

Helps to prevent wheel lock when the brakes are applied suddenly, or if the brakes are applied while driving on a slippery road surface

■ Brake assist

Generates an increased level of braking force after the brake pedal is depressed, when the system detects a panic stop situation.

■ VSC (Vehicle Stability Control)

Helps the driver to control skidding when swerving suddenly or turning on slippery road surfaces.

■ TRC (Traction Control)

Maintains drive power and prevents the rear wheels from spinning when starting the vehicle or accelerating on slippery roads.

■ Hill-start assist control

Prevents the vehicle from rolling backwards when starting on an incline or slippery slope.

■ EPS (Electric Power Steering)

Employs an electric motor to reduce the amount of effort needed to turn the steering wheel.

■ VDIM (Vehicle Dynamics Integrated Management)

Provides integrated control of the ABS, brake assist, TRC, VSC, hill-start assist control and EPS systems.

Maintains vehicle stability when swerving on slippery road surfaces by controlling the brakes, engine output and steering assist.

When the VSC/TRC/hill-start assist control systems are operating



If the vehicle is in danger of slipping, rolling backwards when starting on an incline, or the rear wheels spin, the indicator flashes to indicate that the VSC/TRC/hill-start assist control systems have been engaged.

A buzzer (intermittent) sounds to indicate that VSC is operating.

The stop lights and high mounted stoplight turn on when the hill-start assist control system is operating.

The slip indicator light flashes as well when ABS is operating.

Disabling TRC and/or VSC

If the vehicle gets stuck in fresh snow or mud, TRC and VSC may reduce power from the engine to the wheels. You may need to turn the system off to enable you to rock the vehicle in order to free it.



● Turning off TRC

Quickly press and release the switch to turn off TRC.

The slip indicator light should come on.

Press the switch again to turn the system back on.

● Turning off TRC and VSC

Press and hold the switch for more than 3 seconds while the vehicle is stopped to turn off TRC and VSC.

The slip indicator light will come on and message will be shown on the multi-information display.

Press the switch again to turn the system back on.

■ Automatic reactivation of TRC and VSC

Turning the “ENGINE START STOP” switch OFF after turning off the TRC and VSC systems will automatically re-enable them.

■ Automatic TRC reactivation

If only the TRC system is turned off, the TRC system will turn on when vehicle speed increases.

■ Automatic TRC/VSC reactivation

If the TRC/VSC systems are turned off, the systems will not turn on even when vehicle speed increases.

■ Sounds and vibrations caused by the ABS, brake assist, VSC, TRC and hill-start assist control systems

- A sound may be heard from the engine compartment when the engine is started or just after the vehicle begins to move. This sound does not indicate that a malfunction has occurred in any of these systems.
- Any of the following conditions may occur when the above systems are operating. None of these indicates that a malfunction has occurred.
 - Vibrations may be felt through the vehicle body and steering.
 - A motor sound may be heard after the vehicle comes to a stop.

■ Hill-start assist control is operational when

- The shift lever is in the D or S position.
- The brake pedal is not depressed.

■ EPS operation sound

When the steering wheel operates, a motor sound (whirring sound) may be heard. This does not indicate a malfunction.

■ Reduced effectiveness of EPS

The effectiveness of EPS is reduced to prevent the system from overheating when there is frequent steering input over an extended period of time. The steering wheel may feel heavy as a result. Should this occur, refrain from excessive steering input or stop the vehicle and turn the engine off. The system should return to normal within 10 minutes.

CAUTION

■ The ABS does not operate effectively when

- The limits of tire gripping performance have been exceeded.
- The vehicle hydroplanes while driving at high speed on a wet or slick road.

■ Stopping distance when the ABS is operating on the wet or slick roads

The ABS is not designed to shorten the vehicle's stopping distance. Always maintain a safe distance from the vehicle in front of you in the following situations.

- When driving on dirt, gravel or snow-covered roads
- When driving with tire chains
- When driving over bumps in the road
- When driving over roads with potholes or roads with uneven roads

■ TRC may not operate effectively when

Directional control and power may not be achievable while driving on slippery road surfaces, even if the TRC system is operating.

Do not drive the vehicle in conditions where stability and power may be lost.

■ If the hill- start assist control does not operate effectively

The hill start assist control may not operate effectively on steep inclines and roads covered in ice.

■ When the VSC is activated

The slip indicator light flashes and a warning buzzer sounds. Always drive carefully. Reckless driving may cause an accident. Exercise particular care when the indicator light flashes and a buzzer sounds.

■ When TRC and VSC are off

Be especially careful and drive at a speed appropriate to the road conditions. As these are systems to ensure vehicle stability and driving force, do not turn off TRC and VSC unless necessary.

 **CAUTION****■ Replacing tires**

Make sure that all tires are of the same size, brand, tread pattern and total load capacity. In addition, make sure that the tires are inflated to the appropriate tire pressure level.

The ABS and VSC systems will not function correctly if different tires are fitted on the vehicle.

Contact your Lexus dealer for further information when replacing tires or wheels.

■ Handling of tires and suspension

Using tires with any kind of problem or modifying the suspension will affect the driving assist systems, and may cause the system to malfunction.

Cargo and luggage

Take notice of the following information about storage precautions, cargo capacity and load.

- Stow cargo and luggage in the trunk whenever possible.
- Be sure all items are secured in place.
- Be careful to keep the vehicle level. Placing the weight as far forward as possible helps maintain vehicle balance.
- For better fuel economy, do not carry unnecessary weight.

CAUTION

■ Things that must not be carried in the trunk

The following things may cause a fire if loaded in the trunk.

- Receptacles containing gasoline
- Aerosol cans

■ Storage precautions

● Do not place cargo or luggage in or on the following locations as items may get under the brake or accelerator pedal and prevent them from being depressed properly, block the driver's vision, or hit the driver or passengers, causing an accident.

- At the feet of the driver
- On the front passenger or rear seats (when stacking items)
- Package tray
- Instrument panel
- Dashboard

● Secure all items in the occupant compartment, as they may shift and injure someone during an accident or sudden braking.

■ Load and distribution

- Do not overload your vehicle.
- Do not apply loads unevenly.
Improper loading may cause deterioration of steering or braking control which may cause death or serious injury.

2-5. Driving information

Winter driving tips

Carry out the necessary preparations and inspections before driving the vehicle in winter. Always drive the vehicle in a manner appropriate to the prevailing weather conditions.

■ Pre-winter preparations

- Use fluids that are appropriate to the prevailing outside temperatures.
 - Engine oil
 - Engine coolant
 - Washer fluid
- Have a service technician inspect the level and specific gravity of battery electrolyte.
- Have the vehicle fitted with four snow tires or purchase a set of tire chains for the rear tires.

Ensure that all tires are the same size and brand, and that chains match the size of the tires.

■ Before driving the vehicle

Perform the following according to the driving conditions.

- Do not try to forcibly open a window or move a wiper that is frozen. Pour warm water over the frozen area to melt the ice. Wipe away the water immediately to prevent it from freezing.
- To ensure proper operation of the climate control system fan, remove any snow that has accumulated on the air inlet vents in front of the windshield.
- Remove any ice that has accumulated on the vehicle chassis.
- Periodically check for and remove any excess ice or snow that may have accumulated in the wheel well or on the brakes.

■ When driving the vehicle

Accelerate the vehicle slowly and drive at a reduced speed suitable to road conditions.

■ When parking the vehicle

Park the vehicle and move the shift lever to P without setting the parking brake. The parking brake may freeze up, preventing it from being released.

Selecting tire chains

Use the correct tire chain size when mounting the snow chains. Chain size is regulated for each tire size.

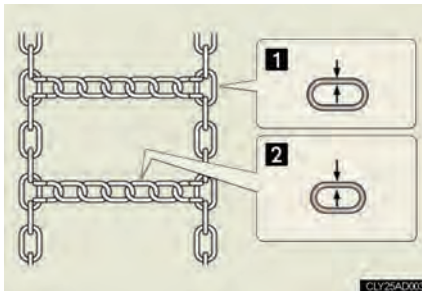

- Side chain
(3 mm [0.12 in.] in diameter)
- Cross chain
(4 mm [0.16 in.] in diameter)

Regulations on the use of snow chains

- Regulations regarding the use of tire chains vary according to location and type of road. Always check local regulations before installing chains.
- Install the chains on the rear tires.
- Retighten the chains after driving 0.5 - 1.0 km (1/4 - 1/2 mile).

■ Tire chains

Observe the following precautions when installing and removing chains.

- Install and remove tire chains in a safe location.
- Install tire chains on the rear tires. Do not install tire chains on front tires.
- Install tire chains following the instructions provided in the accompanying manual.

CAUTION

■ Driving with snow tires

Observe the following precautions to reduce the risk of accidents.

Failing to do so may result in a loss of vehicle control and cause death or serious injury.

- Use tires of the specified size.
- Maintain the recommended level of air pressure.
- Do not drive at speeds in excess of the speed limit or the speed limit specified for the snow tires being used.

■ Driving with tire chains

Observe the following precautions to reduce the risk of accidents.

Failing to do so may result in the vehicle being unable to be driven safely, and may cause death or serious injury.

- Do not drive in excess of the speed limit specified for the tire chains being used or 50 km/h (30 mph), whichever is lower.
- Avoid driving on bumpy road surfaces or over potholes.
- Avoid sudden turns and braking, as use of chains may adversely affect vehicle handling.
- Slow down sufficiently before entering a curve to ensure that vehicle control is maintained.

2-5. Driving information

Trailer towing

Lexus does not recommend towing a trailer with your vehicle. Lexus also does not recommend the installation of a tow hitch or the use of a tow hitch carrier for a wheelchair, scooter, bicycle, etc. Your Lexus is not designed for trailer towing or for the use of tow hitch mounted carriers.

Towing capacity: 0 kg (0 lb.)



3-1. Using the touch	
screen	196
Touch screen	196
Setting the touch screen	198
3-2. Using the air	
conditioning system	
and defogger	204
Front air conditioning system	
(without rear air	
conditioning system).....	204
Front air conditioning system	
(with rear air conditioning	
system)	212
Rear air conditioning	
system.....	221
Rear window and outside	
rear view mirror	
defoggers	228
Windshield wiper de-icer....	229
3-3. Using the audio	
system	230
Audio system type	230
Using the radio	233
Using the CD player	238
Playing MP3 and	
WMA discs	246
Using the DVD player	254
Playing DVD video/audio	257
Playing a video CD	270
DVD player and DVD video	
disc information	274
Optimal use of the audio/	
video system.....	278
Using the AUX adapter	282
Using the rear seat audio	
controls.....	283
Using the steering wheel	
audio switches	287
3-4. Using the rear seat	
entertainment	
system	289
Rear seat entertainment	
system features	289
Using the radio.....	297
Using the front	
DVD changer	298
Using the rear	
DVD player	299
Playing an audio	
CD/CD text	301
Playing WMA (front	
DVD changer only)/	
MP3 discs	302
Playing a DVD video/	
audio.....	303
Playing a video CD	316
DVD player and DVD video	
disc information	320
Using the video mode	331
Changing other setting	333

3-5. Using the hands-free system	
(for cellular phone)	335
Hands-free system	
(for cellular phone).....	335
Using a Bluetooth®	
phone.....	339
Setting the hands-free system	
(for cellular phone).....	351

3-6. Using the interior lights	377
Interior lights list	377
• Interior lights	379
• Personal lights	379

3-7. Using the storage features	381
List of storage features	381
• Glove box.....	383
• Coin holder.....	384
• Door pockets	385
• Cup holders.....	386
• Console box	387
• Cool box	389
• Auxiliary boxes.....	392

3-8. Other interior features	395
Sun visors.....	395
Vanity mirror.....	396
Clock	397
Outside temperature	
display.....	399
Ashtrays	400
Cigarette lighter	401
Power outlet.....	403
Heated steering wheel.....	405
Climate control seats.....	407
Armrest (5-seat models)	410
Rear seat relaxation system	
(4-seat models).....	411
Retractable table	413
Rear sunshade.....	415
Rear door sunshades.....	418
Trunk storage extension.....	421
Coat hooks.....	423
Floor mat.....	424
Trunk features	425

3-1. Using the touch screen

Touch screen

By touching the screen with your finger, you can control the audio system and air conditioning system, and adjust the screen display, etc.

Press  to display the “Information” screen.



Button/switch	Page
“CLIMATE”	P. 204, 212
“AUDIO”	P. 230
“INFO” (Displaying the “Information” screen)	P. 196
“DISP” (Adjusting the display)	P. 199
“Telephone”	P. 339
“LEXUS Park Assist”	P. 171
“Screen setting”	P. 198
“Beep off”	P. 198
“Adjust clock”	P. 397

The initial screen



If the “ENGINE START STOP” switch is set to ACCESSORY or IGNITION ON mode, the initial screen will be displayed for a few seconds as the system starts up.

■ To avoid damaging the touch screen

- Touch the screen lightly with your finger. If there is no response, remove your finger from the screen and try again.
- Remove any dirt on the screen by wiping with a soft cloth. Do not use detergent.

■ When using the touch screen

- If the screen is cold, the display may be dark, or the system may seem to be operating slightly slower than normal.
- The screen may seem dark and hard to see when viewed through sunglasses. Change your angle of viewing, adjust the display on the “Display” screen, or remove your sunglasses.

3-1. Using the touch screen

Setting the touch screen

You can change the touch screen to your desired settings.

Turning off the beep sound

The beep that sounds when a touch screen switch is touched can be turned off.

STEP 1 Press  .



Touch  .

Adjusting the display

STEP 1 Press



STEP 2 Adjust the display as desired using **R** / **G** and **-** / **+**.

If you do not touch the screen for 20 seconds, the system will return to the previous screen.

► With CD mode



► With DVD mode



	R	G
Colour	Red	Green
	-	+
Tone	Lighter	Darker
Contrast	Weaker	Stronger
Brightness	Darker	Brighter

■ “Day mode”



When the headlights are turned on, the screen dims. However, the screen can be switched to “Day Mode”.

The screen will stay in “Day Mode” when the headlights are turned on until  is touched again.

■ To turn off the picture display

If  is touched, the screen display is turned off, and guidance is by voice only.

■ Opening or closing the rear display (if equipped)



Touching  opens or closes the rear display.

Screen settings

The following screen settings can be changed.



1 Automatic transition

20 seconds after audio system use, the system will return the display to the previous screen.

2 Switch colour

You can select the switch color.

3 Rear system lock (if equipped)

The operation lock on the rear seat entertainment system can be turned on or off.

4 Personal data deletion

The following personal data is deleted:

- User selection settings
- Phone book data
- Dialed numbers and received calls
- Speed dial
- Bluetooth[®] phone data
- Security code

■ Setting automatic transition

STEP 1 Press  .

STEP 2 Touch  on the “Information” screen.

STEP 3 Touch  or  on the “Screen Setting” screen.

STEP 4 Touch  .

■ Setting the switch color

STEP 1 Press  .

STEP 2 Touch  on the “Information” screen.

STEP 3 Touch  or  on the “Screen setting” screen.

STEP 4 Touch  .

■ Setting the rear system lock

STEP 1 Press  .

STEP 2 Touch  on the “Information” screen.

STEP 3 Touch  or  on the “Screen setting” screen.

STEP 4 Touch  .

■ To delete personal data

STEP 1 Press  .

STEP 2 Touch  on the “Information” screen.

STEP 3 Touch  on the “Screen setting” screen.



Touch  .

Check carefully beforehand, as data cannot be retrieved once deleted.

■ When deleting personal data

Data can only be deleted when the vehicle is stopped.

■ When selling the vehicle

Be sure to delete both the call history and personal data.

■ If you touch

The display returns to the previous screen.

3-2. Using the air conditioning system and defogger Front air conditioning system (without rear air conditioning system)

Airflow and outlets are automatically adjusted according to the temperature setting.

Press  to display the air conditioning operation screen.

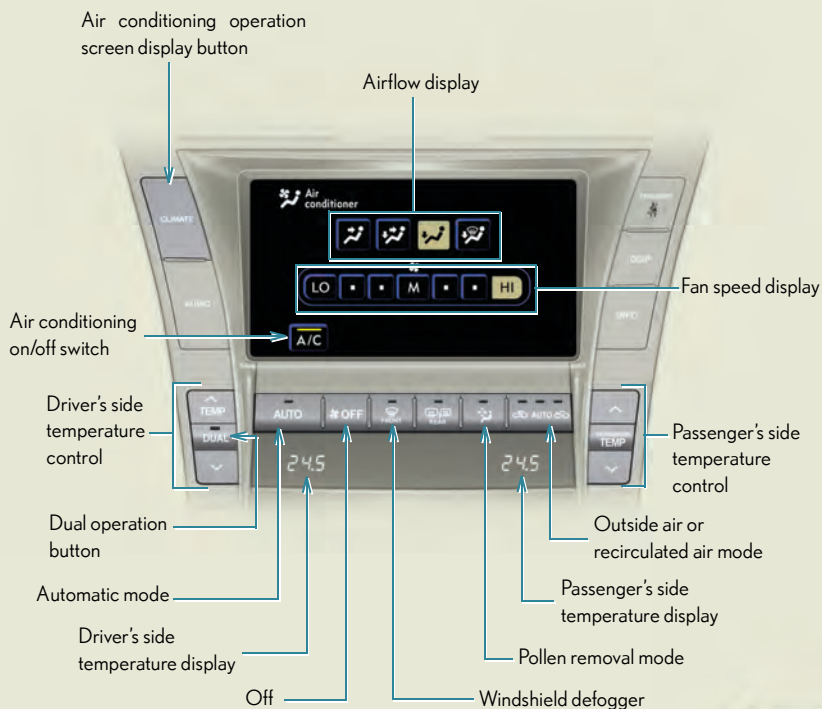

CLY32AD063

Using the automatic mode

STEP 1 Press .

➔ The air conditioning system will begin to operate. Air outlets and fan speed are automatically adjusted according to the temperature setting.

STEP 2 Press  to switch to automatic air intake mode.

➔ The air conditioning system automatically switches between outside air and recirculated air modes.

STEP 3 Press \wedge on  to increase the temperature and \vee to decrease the temperature.

The temperature for the driver and passenger seats can be set separately.



Adjusting the settings

■ Adjusting the temperature setting

Press \wedge on  to increase the temperature and \vee to decrease the temperature.

The air conditioning system switches between dual and simultaneous modes each time  is pressed.

Dual mode (the indicator on  is on.): The temperature for the left-hand seat and right-hand seat can be adjusted separately. Operating the passenger's side temperature control will enter dual mode.

Simultaneous mode (the indicator on  is off.): Only  (driver's side) can be used to adjust the temperature for all seats.

■ Adjusting the fan speed

Touch any switch of  (decrease ↔ increase) on the operation screen.

Press  to turn the fan off.

■ Changing the air outlets



Touch any mode on the operation screen.

Air flows as shown below according to the mode selected.

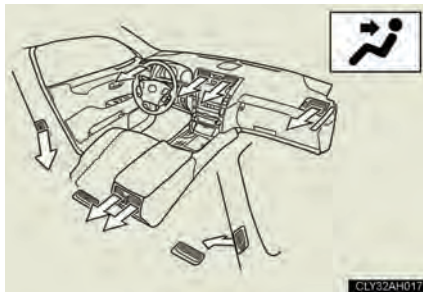

Upper body

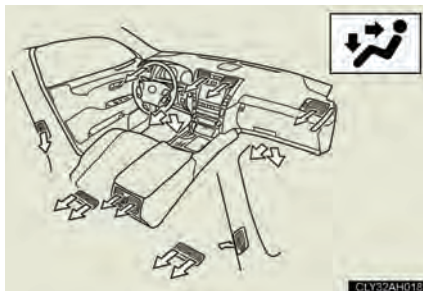

Upper body and feet

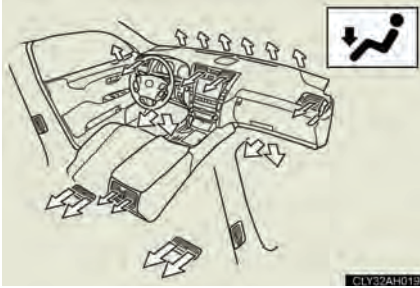

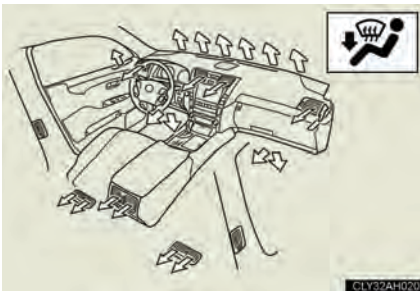

Feet



Feet and front windshield

■ Switching between outside air and recirculated air modes

Press  .

The mode switches between  (recycles air inside the vehicle), "AUTO" and  (introduces air from outside the vehicle) modes each time the button is pressed.

When the air intake control system is switched to automatic mode, it operates automatically.

Defogging the windshield

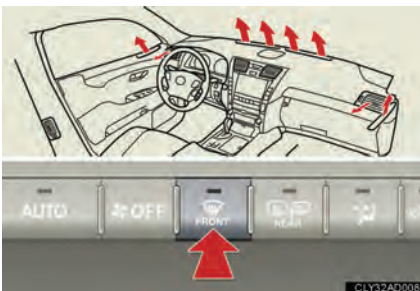

Press  .

The air conditioning system control operates automatically.

Pollen removal mode

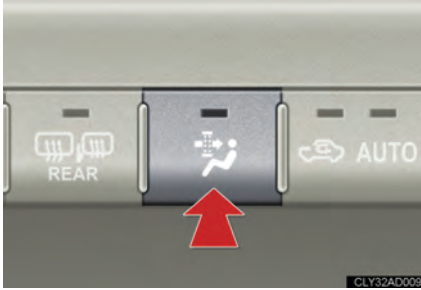

Press .

Outside air mode switches to  (recirculated air) mode. Pollen is removed from the air and the air flows to the upper part of the body.

Usually the system will turn off automatically after approximately 3 minutes.

To stop the operation, press  again.

Adjusting the sensitivity of the air intake control in automatic mode

STEP 1 Press  until the “Smog sensor” screen appears while the vehicle is stopped.

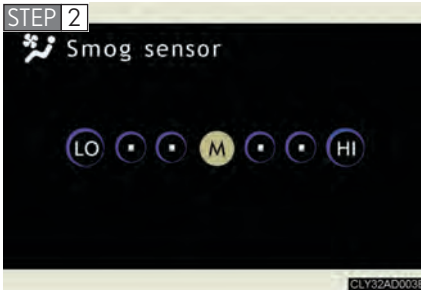

Touch any switch of  (lower sensitivity ↔ higher sensitivity) on the operation screen.

Adjusting the position and opening and closing the air outlets

► Front center outlets

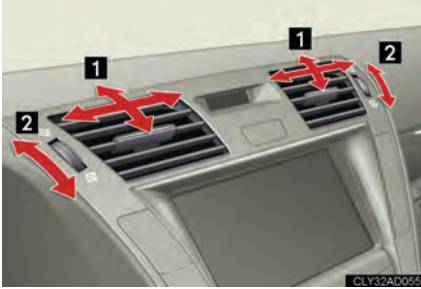

- 1** Direct air flow to the left or right, up or down.
- 2** Turn the knob to open or close the vent.

► Front side outlets

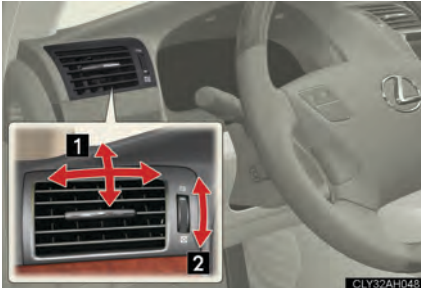

- 1** Direct air flow to the left or right, up or down.
- 2** Turn the knob to open or close the vent.

► Rear center outlets

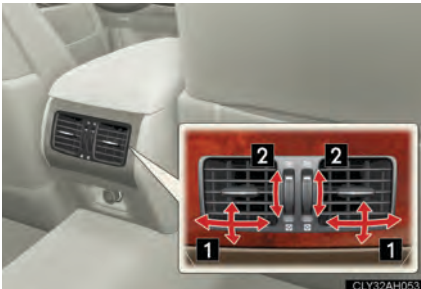

- 1** Direct air flow to the left or right, up or down.
- 2** Turn the knob to open or close the vent.

► Rear side outlets



- 1 Direct air flow to the left or right, up or down.
- 2 Turn the knob to open or close the vent.

■ Using the automatic mode

Fan speed is adjusted automatically in accordance with the temperature setting and ambient conditions. As a result, the following may occur.

- The system may switch automatically to recirculated mode when the coolest temperature setting is selected in summer.
- Immediately after  is pressed, the fan may stop for a while until warm or cool air is ready to flow.
- Cool air may flow to the area around the upper body when the heater is on.

■ Using the system in recirculated air mode

The windows will fog up more easily if the recirculated air mode is used for an extended period.

■ Window defogger feature

Recirculated air mode may automatically switch to  (outside air) mode in situations where the windows need to be defogged.

■ When outside temperature approaches 0°C (32°F)



The air conditioning system may not operate even when  is touched.

■ Automatic mode for air intake control

In automatic mode, the system detects exhaust gas and other pollutants and automatically switches between outside air and recirculated air modes.

When the air conditioning is off, and the fan is operating, turning the "AUTO" mode on will activate the air conditioning system.

■ Pollen removal mode

- When the outside air is cold, the following may occur.
 - Outside air mode does not switch to .
 - The air conditioning system operates automatically.
 - The operation cancels after 1 minute.
- In rainy weather, the windows may fog up. Press .

CAUTION

■ To prevent the windshield from fogging up

Do not use  during cool air operation in extremely humid weather. The difference between the temperature of the outside air and that of the windshield can cause the outer surface of the windshield to fog up, blocking your vision.

NOTICE

■ To prevent the battery from being discharged

Do not leave the air conditioning system on longer than necessary when the engine is off.

3-2. Using the air conditioning system and defogger Front air conditioning system (with rear air conditioning system)

Airflow and outlets are automatically adjusted according to the temperature setting.

Press  to display the air conditioning operation screen.

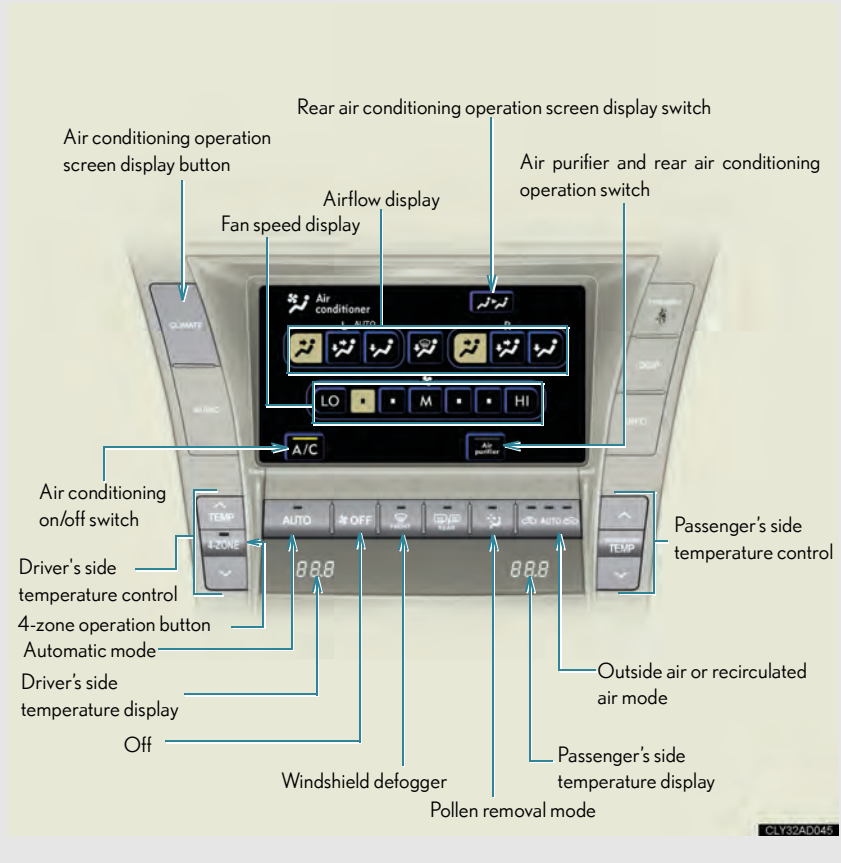

Using the automatic mode



STEP 1 Press  .

➔ The air conditioning system will begin to operate. Air outlets and fan speed are automatically adjusted according to the temperature setting.

“AUTO” will be displayed on the control panel.

STEP 2 Press  to switch to automatic air intake mode.



➔ The air conditioning system automatically switches between outside air and recirculated air modes.

STEP 3 Press  on  to increase the temperature and  to decrease the temperature.

Air outlets and fan speed for the right-hand and left-hand seats may be set separately depending on the temperature setting.



Adjusting the settings

■ Adjusting the temperature setting

Press  on  to increase the temperature and  to decrease the temperature.

The air conditioning system switches between individual and simultaneous modes each time  is pressed.

Individual mode (the indicator on  is on.): The temperature for the driver's, front passenger's and rear seats (→P. 221) can be adjusted separately. Operating the passenger's side temperature control will enter individual mode.

Simultaneous mode (the indicator on  is off.): Only  (driver's side) can be used to adjust the temperature for all seats.

■ Adjusting the fan speed

Touch any switch of  (decrease ↔ increase) on the operation screen.

Press  to turn the fan off.

■ Changing the air outlets



Touch any mode on the operation screen.

- 1 L: Left-hand front seat
- 2 R: Right-hand front seat

Different air outlets for the left-hand and right-hand front seats can be chosen.

Air flows as shown below according to the mode selected.

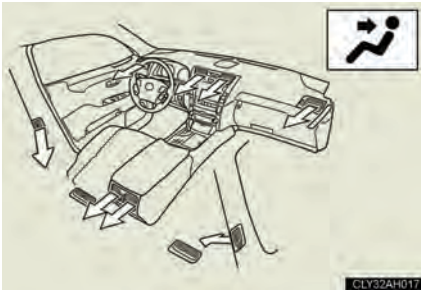

Upper body

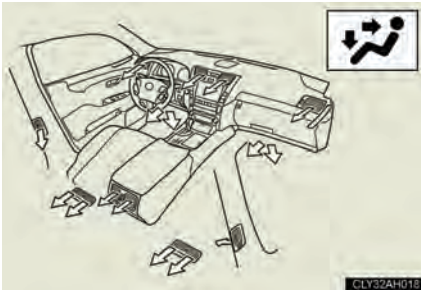

Upper body and feet

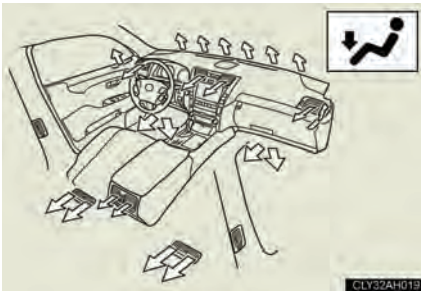

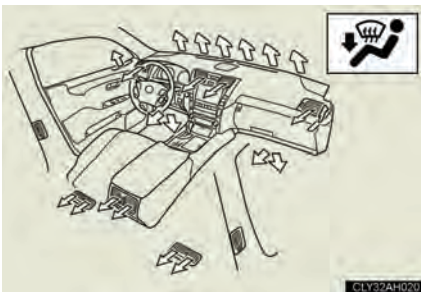

Feet



Feet and front windshield

■ Switching between outside air and recirculated air modes

Press .

The mode switches between  (recycles air inside the vehicle), "AUTO" and  (introduces air from outside the vehicle) modes each time the button is pressed.

When the air intake control system is switched to automatic mode, it operates automatically.

Turning the air purifier off

Touch  on the operation screen.

The air purifier will turn off when the indicator on the switch goes off. Air will not flow from the roof vents.



To turn the air purifier on, touch  again.

Changing the rear seat settings

■ Adjusting the temperature setting

STEP 1 Touch .



Touch  (increase) or  (decrease) on the operation screen. Operating the switch will enter individual mode.

1 L: Left-hand rear seat

2 R: Right-hand rear seat

The air conditioning system switches between individual and simultaneous modes each time  is pressed.

■ Adjusting the fan speed (air purifier and cooler from the roof vents)

STEP 1 Touch .

STEP 2 Touch any switch of  (decrease ↔ increase) on the operation screen.

According to the air outlets currently selected, the fan speed of either the cool air from the roof vents or air purifier will be adjusted.
(→P. 225)

Press  to turn the fan off.

Defogging the windshield

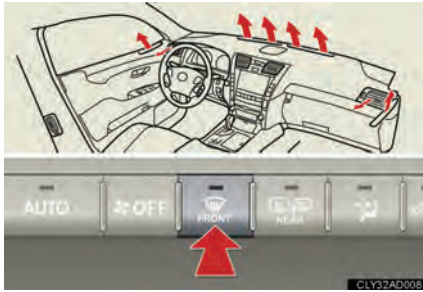

Press .

The air conditioning system control operates automatically.

Pollen removal mode



Press .

Outside air mode switches to  (recirculated air) mode. Pollen is removed from the air and the air flows to the upper part of the body.

Usually the system will turn off automatically after approximately 3 minutes.

To stop the operation, press  again.

Adjusting the sensitivity of the air intake control in automatic mode

STEP 1 Press  until the “Smog sensor” screen appears while the vehicle is stopped.

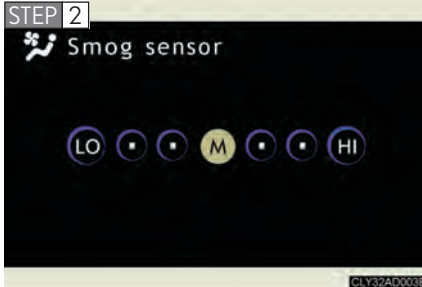

Touch any switch of  (lower sensitivity ↔ higher sensitivity) on the operation screen.

Adjusting the position and opening and closing the air outlets

► Front center outlets

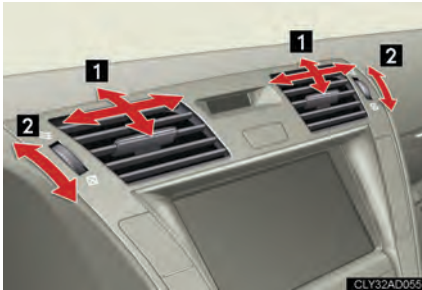

- 1 Direct air flow to the left or right, up or down.
- 2 Turn the knob to open or close the vent.

► Front side outlets

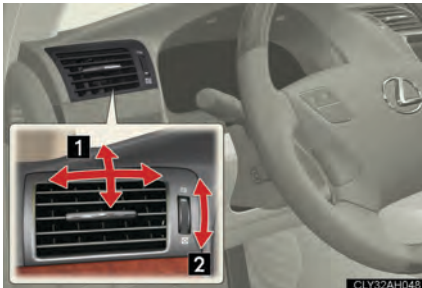

- 1 Direct air flow to the left or right, up or down.
- 2 Turn the knob to open or close the vent.

Air outlets of rear seat. (→P. 225)

■ Using the automatic mode

Fan speed is adjusted automatically in accordance with the temperature setting and ambient conditions. As a result, the following may occur.

- The system may switch automatically to recirculated mode when the coolest temperature setting is selected in summer.
- Immediately after  is pressed, the fan may stop for a while until warm or cool air is ready to flow.
- Cool air may flow to the area around the upper body when the heater is on.

■ Using the system in recirculated air mode

The windows will fog up more easily if the recirculated air mode is used for an extended period.

■ Window defogger feature

Recirculated air mode may automatically switch to  (outside air) mode in situations where the windows need to be defogged.

■ When outside temperature approaches 0°C (32°F)



The air conditioning system may not operate even when  is touched.

■ Automatic mode for air intake control

In automatic mode, the system detects exhaust gas and other pollutants and automatically switches between outside air and recirculated air modes.

When the air conditioning is off, and the fan is operating, turning the “AUTO” mode on will activate the air conditioning system.

■ Pollen removal mode

- When the outside air is cold, the following may occur.
 - Outside air mode does not switch to .
 - The air conditioning system operates automatically.
 - The operation cancels after 1 minute.
- In rainy weather, the windows may fog up. Press .

■ Air purifier

The air purifier will turn on when turning the rear air conditioning system on.

 CAUTION

■ **To prevent the windshield from fogging up**

Do not use  during cool air operation in extremely humid weather. The difference between the temperature of the outside air and that of the windshield can cause the outer surface of the windshield to fog up, blocking your vision.

 NOTICE

■ **To prevent the battery from being discharged**

Do not leave the air conditioning system on longer than necessary when the engine is off.

3-2. Using the air conditioning system and defogger Rear air conditioning system (if equipped)

Airflow and outlets are automatically adjusted according to the temperature setting.

► 5-seat models

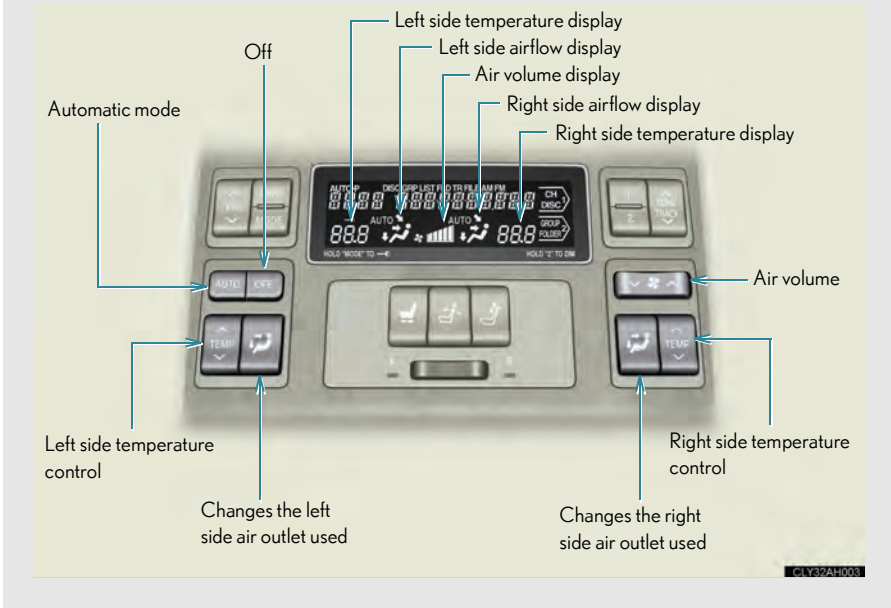

► 4-seat models

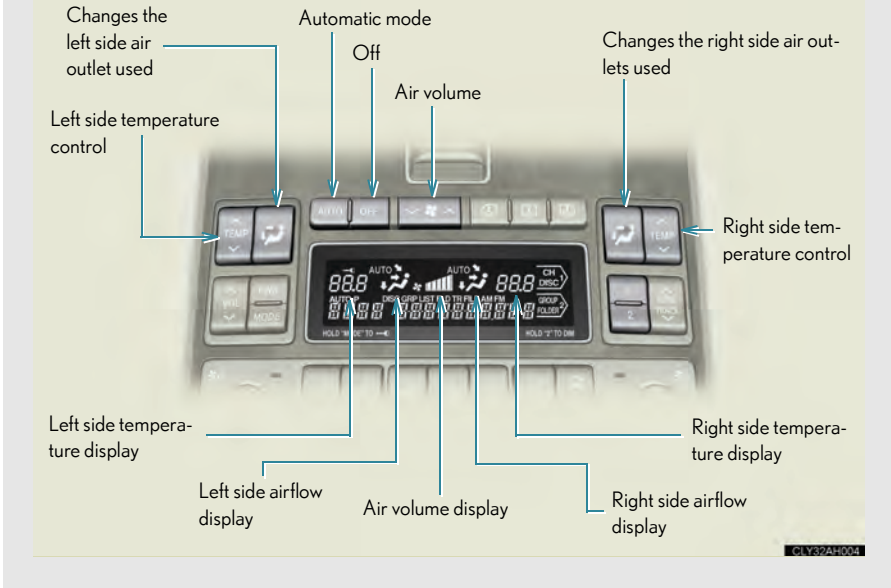



Using the automatic mode

STEP 1 Press .

➔ The air conditioning system and air purifier will operate, and air outlets and fan speed will be set automatically.

“AUTO” will be displayed on the control panel.

STEP 2 Press  on  to increase the temperature and  to decrease the temperature.

Air outlets and fan speed for the right-hand and left-hand seats may be set separately depending on the temperature setting.

Adjusting the settings

■ Adjusting the temperature setting

Press \wedge on  to increase the temperature and \vee to decrease the temperature.

Air outlets and fan speed for the right-hand and left-hand seats may be set separately depending on the temperature setting.

■ Changing the air outlets

Press .

The air outlets change as follows each time  is pressed.

Different air outlets for the right-hand and left-hand rear seats can be chosen.

Air flows as shown below according to the mode selected.

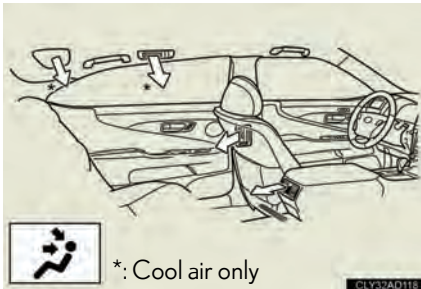

Upper body

When the indicator on  (on the front operation screen) is on

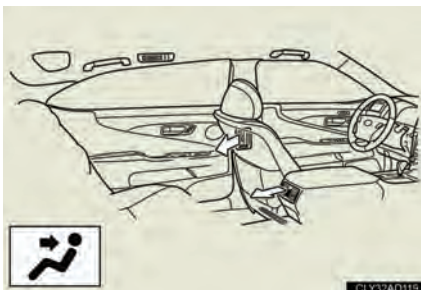

Upper body

When the indicator on  (on the front operation screen) is off



Upper body and feet

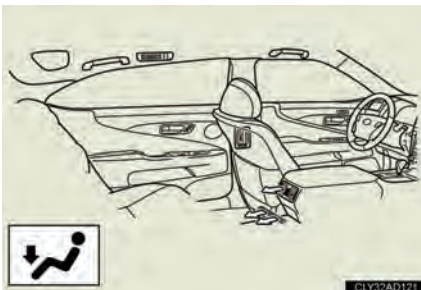

Feet

■ Adjusting the air volume

The volume of cool air or air from the air purifier can be adjusted according to the mode selected.

Press \wedge (increase) or \vee (decrease) on .

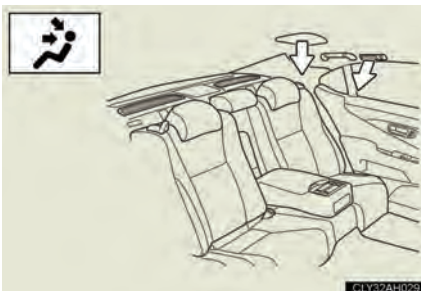

Cool air flows from roof vents.

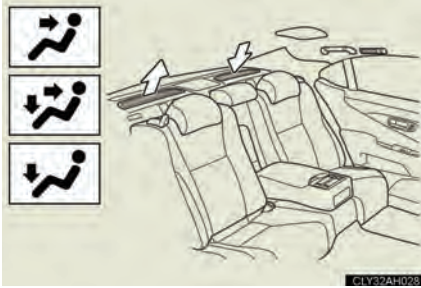

Air purifier operation (air flows from the rear package tray.)

Press  to turn the fan off.

Adjusting the position and opening and closing the air outlets

► Rear center outlets

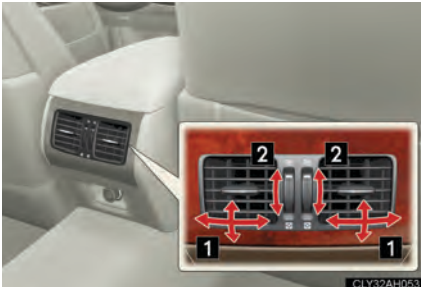

- 1 Direct air flow to the left or right, up or down.
- 2 Turn the knob to open or close the vent.

► Rear side outlets



- 1 Direct air flow to the left or right, up or down.
- 2 Turn the knob to open or close the vent.

► Roof side outlets

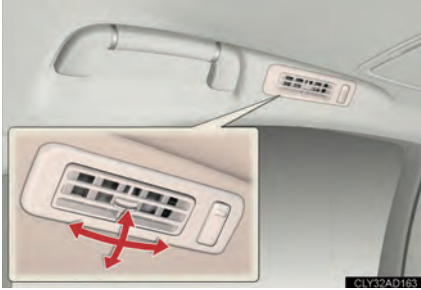

Direct air flow to the left or right, up or down.

■ Button lock function

► 5-seat models



To prevent inadvertent operation, the buttons on the rear armrest can be locked. Press **MODE** until you hear a beep to lock the buttons.

Pressing **MODE** again until you hear a beep will release the lock.

The indicator appears on the display when the buttons are locked.

► 4-seat models



■ Rear control panel illumination off function

▶ 5-seat models



Control panel illumination on the rear arm-rest can be turned off. Press **2** until you hear a beep to turn the illumination off. Pressing **2** again until you hear a beep will turn the illumination on.

▶ 4-seat models



■ Replacing the rear air conditioning filter

Replacing the air filter when using rear air conditioning or air purifier reduces air flow or deodorizing performance (→P. 472).

⚠ NOTICE

■ To prevent the battery from being discharged

Do not leave the air conditioning system on longer than necessary when the engine is off.

3-2. Using the air conditioning system and defogger

Rear window and outside rear view mirror defoggers

These features are used to defog the rear window, and to remove rain-drops, dew and frost from the outside rear view mirrors.



On/off

Press the button to turn on the rear window and outside rear view mirror defogger. The defoggers will automatically turn off after approximately 15 minutes.

Pressing the button again also turns the defoggers off.

CAUTION

■ When the outside rear view mirror defoggers are on

Do not touch the outside surface of the rear view mirrors, as they can become very hot and burn you.

3-2. Using the air conditioning system and defogger Windshield wiper de-icer (if equipped)

This feature is used to prevent ice from building up on the windshield and wiper blades.

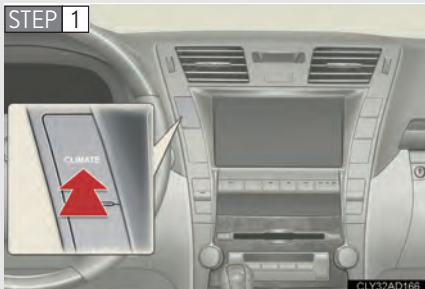

Press  to display the air conditioning operation screen.



On/off

Touch the switch to turn on the windshield wiper de-icer. The windshield wiper de-icer will automatically turn off after approximately 15 minutes.

Touching the switch again also turns the de-icer off.

CAUTION

■ When the windshield wiper de-icer is on

Do not touch the glass at the lower part of the windshield or to the side of the front pillars as the surfaces can become very hot and burn you.

3-3. Using the audio system

Audio system type

CD and (optional) DVD player with changer and AM/FM radio

Press  to display the audio operation screen.

This illustration below is for a vehicle equipped with DVD player.



The audio system appearance and screen may differ slightly for vehicles not equipped with the DVD player.

CD player: Plays audio CDs, CD text, MP3 discs and WMA discs.

DVD player: Plays audio CDs, CD text, video CDs, MP3 discs, WMA discs, DVD video discs and DVD audio discs.

Title	Page
Using the radio	P. 233
Using the CD player	P. 238
Playing MP3 and WMA discs	P. 246
Using the DVD player	P. 254
Playing DVD video/audio	P. 257
Playing a video CD	P. 270
DVD player and DVD video disc information	P. 274
Optimal use of the audio/video system	P. 278
Using the AUX adapter	P. 282
Using the rear seat audio controls	P. 283
Using the steering wheel audio switches	P. 287

■ Using cellular phones

Interference may be heard through the audio system's speakers if a cellular phone is being used inside or close to the vehicle while the audio system is operating.



NOTICE

■ **To prevent the battery from being discharged**

Do not leave the audio system on longer than necessary when the engine is off.

■ **To avoid damaging the audio/video system**

Take care not to spill drinks or other fluids on the audio system.

3-3. Using the audio system

Using the radio

Press **AM** or **FM** to choose either an AM or FM band.

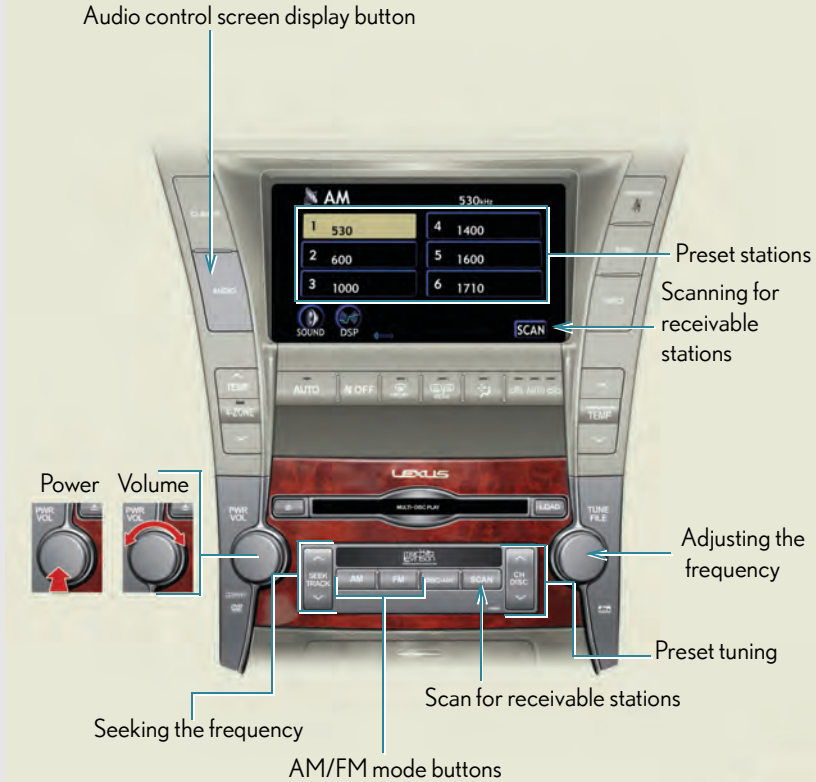

This illustration is for a vehicle equipped with the DVD player.

Setting station presets

STEP 1 Search for desired stations by turning  or pressing







STEP 2 Touch and hold one of the preset stations (1 - 6) until you hear a beep.

Scanning radio stations

■ Scanning the preset radio stations

▶ AM station

STEP 1 Touch  on the screen or press  until "P-SCAN" appears.
Preset stations will be played for a few seconds each.

STEP 2 When the desired station is reached, touch  or press  once again.



▶ FM station



STEP 1 Press  until "P-SCAN" appears.

STEP 2 When the desired station is reached, press  once again.

■ Scanning all radio stations within range

▶ AM station

STEP 1 Touch  on the screen or press  .
"SCAN" appears on the screen and all stations within range will be played for a few seconds each.

STEP 2 When the desired station is reached, touch  or press  once again.

▶ FM station

STEP 1 Press  .
"SCAN" appears on the screen and all stations with reception will be played for a few seconds each.

STEP 2 When the desired station is reached, press  once again.

RDS (Radio Data System)

This feature allows your radio to receive station identification information and program information (classical, jazz, etc.) from radio stations which broadcast this information.

Receiving RDS broadcasts

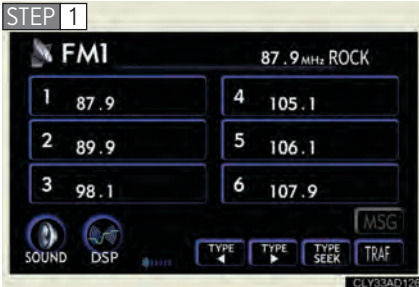

Touch **TYPE** or **TYPE** on the screen.

The type of program changes each time the button is pressed.

- ROCK
- EASYLIS (Easy listening)
- CLS/JAZZ (Classical music and Jazz)
- R & B (Rhythm and Blues)
- INFORM (Information)
- RELIGION
- MISC (Miscellaneous)
- ALARM (Emergency messages)

If the system receives no RDS stations, “NO PTY” appears on the display.

When a program is set, “TYPE SEEK” appears.

STEP 2 Touch **TYPE SEEK** on the screen or press \wedge or \vee on .

The radio seeks or scans the station by the relevant program type.

If no radio station of that type is found, "NOTHING" appears on the screen.

■ Displaying radio text messages



Touch **MSG** on the screen.

If "MSG" appears on the screen, a text message may be displayed.

■ Traffic announcement



Touch **TRAF** on the screen.

"TRAF SEEK" appears on the display, and the radio will start seeking any station broadcasting traffic program information.

If no traffic program station is found, "NOTHING" appears on the display.

■ When the battery is disconnected

All preset stations are erased.

■ Reception sensitivity

- Maintaining perfect radio reception at all times is difficult due to the continually changing position of the antenna, differences in signal strength and surrounding objects, such as trains, transmitters, etc.
- The radio antenna is mounted inside the rear window. To maintain clear radio reception, do not attach metallic window tinting or other metallic objects to the antenna wire mounted inside the rear window.

3-3. Using the audio system

Using the CD player

Insert a disc or press **DISC-ALL** with a disc inserted.

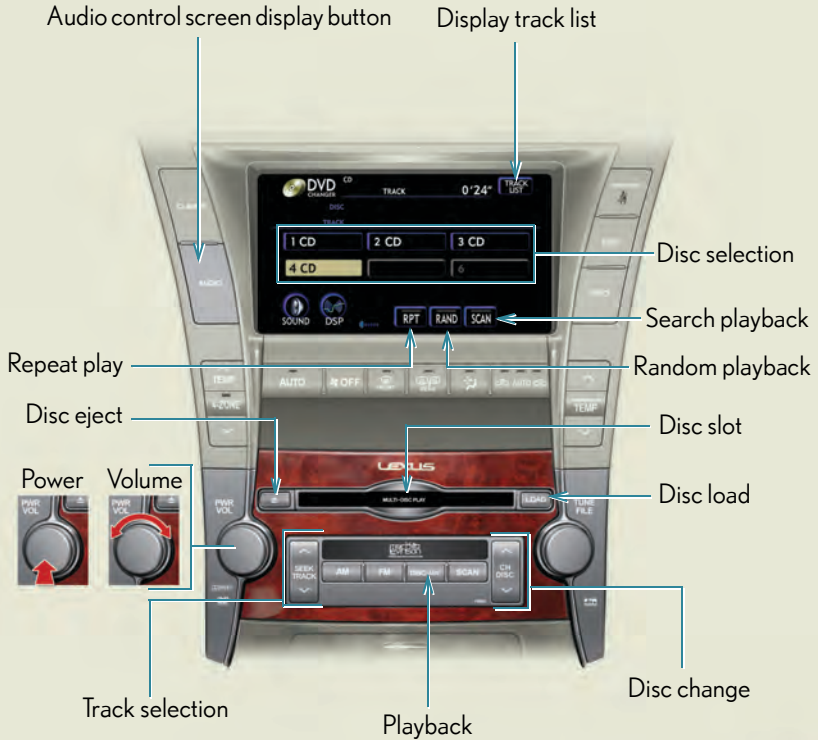

This illustration is for a vehicle equipped with the DVD player.

Loading a disc

■ Loading a single disc

STEP 1 Press .

STEP 2 When the indicator changes from flashing amber to green, insert a disc after the disc slot door opens.

■ Loading multiple discs

STEP 1 Press and hold  until you hear a beep.

STEP 2 When the indicator changes from flashing amber to green, insert a disc after the disc slot door opens.

STEP 3 After inserting a disc, wait until the indicator changes from flashing amber to green, then insert the next disc after the disc slot door has opened.

STEP 4 Repeat steps 2 and 3 until you have inserted all discs.

To cancel the operation, press the  or  button. If you do not insert a disc within 15 seconds, loading will be canceled automatically.

Ejecting discs

■ Ejecting a disc

STEP 1 To select the disc to be ejected, touch the desired disc on the screen or press \wedge or \vee on .

STEP 2 Press  and remove the disc.

■ Ejecting all discs

Press and hold  until you hear a beep, then remove the discs.

Selecting, fast forwarding and scanning tracks

■ Selecting a track

Press \wedge to move up and \vee to move down using  until the desired track number appears on the screen.

To fast forward or rewind, press and hold \wedge or \vee on .



■ Selecting a track from the track list

STEP 1 Touch  on the screen.

STEP 2



Touch the desired track number.

 or : changes the list by 6 track groups.

This function is available only when the vehicle is not moving.

■ Scanning a disc

STEP 1 Touch  on the screen.

“SCAN” appears on the screen.

The first 10 seconds of each track will be played.

STEP 2 Touch  once again when the desired track is reached.

Selecting a disc

■ Selecting a disc to play

Touch the desired disc on the screen or press \wedge or \vee on



(→P. 238)

■ Selecting loaded discs

STEP 1 Touch and hold **SCAN** on the screen until “D-SCAN” appears.

The first 10 seconds of the first track on each disc will be played.

STEP 2 Touch **SCAN** once again when the desired disc is reached.

Random playback

■ Current disc

Touch **RAND** on the screen.

Songs are played in random order.

■ All discs

Touch and hold **RAND** on the screen until “D-RAND” appears.

Tracks on all loaded discs are played in random order.

Repeating a track or a disc

■ Repeating a track

Touch **RPT** on the screen.

■ Repeating a disc

Touch **RPT** on the screen and hold until “D-RPT” appears.

■ **Canceling random, repeat and scan playback**

Touch **RAND**, **RPT**, or **SCAN** on the screen once again.

■ **Displaying the title and artist name**

If a CD-TEXT disc is inserted, the titles of the disc and track will be displayed. Up to 16 letters can be displayed.

■ **Error messages**

Refer to the following table and take the appropriate measures. If the problem is not rectified, take the vehicle to your Lexus dealer.

Message	Cause	Correction Procedures
No CD or No disc	There is no disc in the changer	Insert a disc
Check CD X or Check DISC X	<ul style="list-style-type: none"> • The disc X is dirty or damaged • The disc X is inserted upside down • The disc X is not playable with the player 	<ul style="list-style-type: none"> • Clean the disc • Insert the disc correctly • Confirm the disc is playable with the player
CD error or DVD error	<ul style="list-style-type: none"> • There is a malfunction within the system • Operation is stopped due to a high temperature inside the player 	<ul style="list-style-type: none"> • Eject the disc • Eject the disc and allow the player to cool down
NO MUSIC FILE	This indicates that no playable data is included in the disc	Eject the disc

■ Discs that can be used

Discs with the marks shown below can be used.

Playback may not be possible depending on recording format or disc features, or due to scratches, dirt or deterioration.



CDs with copy-protection features may not play correctly.

■ CD player protection feature

To protect the internal components, playback is automatically stopped when a problem is detected.

■ If discs are left inside the CD player or in the ejected position for extended periods

Discs may be damaged and may not play properly.

■ Lens cleaners

Do not use lens cleaners. Doing so may damage the CD player.

 NOTICE

■ Discs and adapters that cannot be used

Do not use the following types of discs, 8 cm (3 in.) disc adapters or Dual Disc. Doing so may damage the player and/or disc insert/eject function.



- Discs that have a diameter that is not 12 cm (4.7 in.).



- Low-quality or deformed discs.



- Discs with a transparent or translucent recording area.



- Discs that have tape, stickers or CD-R labels attached to them, or that have had the label peeled off.

 NOTICE**■ Player precautions**

Failure to follow the precautions below may result in damage to the discs or the player itself.

- Do not insert anything other than discs into the disc slot.
- Do not apply oil to the player.
- Store discs away from direct sunlight.
- Never try to disassemble any part of the player.



- Do not insert more than one disc at a time.

3-3. Using the audio system

Playing MP3 and WMA discs

Insert an MP3 or WMA disc or press **DISC/AUX** with a disc inserted.

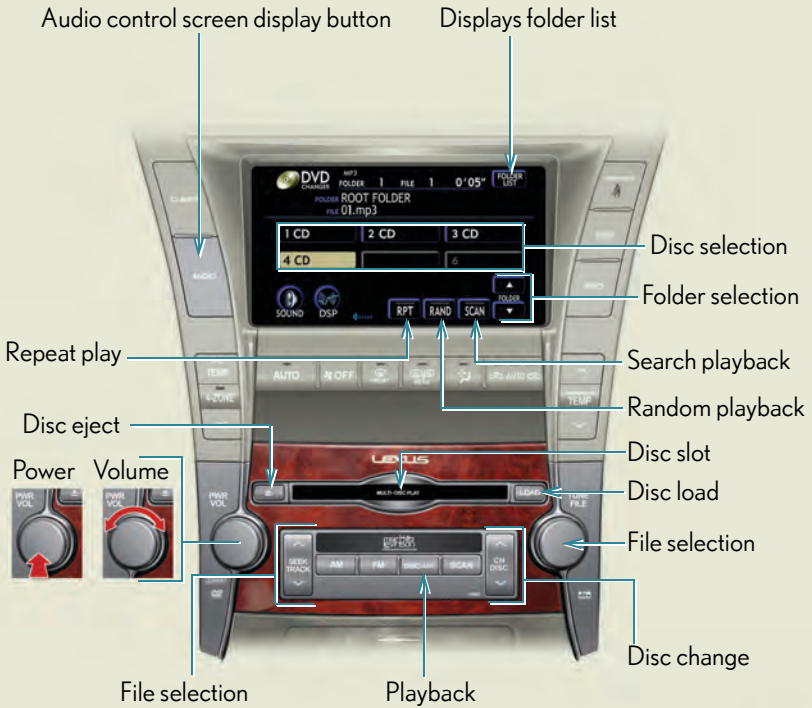



This illustration is for a vehicle equipped with the DVD player.

Loading, ejecting and selecting MP3 and WMA discs

→P. 238

Selecting a folder

■ Selecting a folder



Touch “FOLDER ” or “” on the screen to select the next/previous folder.

■ Selecting a folder from the folder list

STEP 1 Touch  on the screen.



Touch the desired folder number.



 or : changes the list by 6 folder groups.

: displays the details of the file currently playing.

: displays the file list.

This function is available only when the vehicle is not moving.

■ Selecting the desired folder by cueing the first file of each folder

Touch and hold  on the screen until “FLD·SCAN” appears. When the desired folder is reached, touch  once again.

Selecting and scanning files

■ Selecting one file at a time

Turn  or press \wedge or \vee on  to select the desired file.

■ Selecting a file from the file list



STEP 1 Touch  on the screen to turn the folder list on.



Touch  on the folder list screen.



Touch the desired file number.

 or : changes the list by 6 groups.

: displays the folder list.

: displays the details of the file currently playing.

This function is available only when the vehicle is not moving.

■ Selecting a desired file by cueing the files in the folder

Touch  on the screen.

When the desired file is reached, touch  once again.

Repeat play

■ Repeating a file

Touch **RPT** on the screen.

■ Repeating all of the files in a folder

Touch and hold **RPT** on the screen until the “FLD RPT” appears.

Random playback

■ Playing files from a particular folder in random order

Touch **RAND** on the screen.

■ Playing all the files on a disc in random order

Touch and hold **RAND** on the screen until “FLD RAND” appears.

■ Canceling random, repeat and scan playback

Touch **RAND**, **RPT** or **SCAN** on the screen once again.

■ Error messages

→P. 242

■ CD player protection feature

To protect the internal components, playback is automatically stopped when a problem is detected.

■ If discs are left inside the CD player or in the ejected position for extended periods

Discs may be damaged and may not play properly.

■ Lens cleaners

Do not use lens cleaners. Doing so may damage the CD player.

■ MP3 and WMA files

MP3 (MPEG Audio LAYER 3) is a standard audio compression format.

Files can be compressed to approximately 1/10 of their original size by using MP3 compression.

WMA (Windows Media TMAudio) is a Microsoft audio compression format.

This format compresses audio data to a size smaller than that of the MP3 format.

There is a limit to the MP3 and WMA file standards that can be used and to the media/formats on which the files are recorded.

● MP3 file compatibility

- Compatible standards
MP3 (MPEG1 LAYER3, MPEG2 LSF LAYER3)
- Compatible sampling frequencies
MPEG1 LAYER3: 32, 44.1, 48 (kHz)
MPEG2 LSF LAYER3: 16, 22.05, 24 (kHz)
- Compatible bit rates (compatible with VBR)
MPEG1 LAYER3: 64, 80, 96, 112, 128, 160, 192, 224, 256, 320 (kbps)
MPEG2 LSF LAYER3: 64, 80, 96, 112, 128, 144, 160 (kbps)
- Compatible channel modes: stereo, joint stereo, dual channel and monaural

- WMA file compatibility

- Compatible standards
WMA Ver. 7, 8, 9
- Compatible sampling frequencies
32, 44.1, 48 (kHz)
- Compatible bit rates (only compatible with 2-channel playback)
Ver. 7, 8: CBR 48, 64, 80, 96, 128, 160, 192 (kbps)
Ver. 9: CBR 48, 64, 80, 96, 128, 160, 192, 256, 320 (kbps)

- Compatible media

Media that can be used for MP3 and WMA playback are CD-Rs and CD-RWs.

Playback in some instances may not be possible if the CD-R or CD-RW is not finalized. Playback may not be possible or the audio may jump if the disc is scratched or marked with fingerprints.

- Compatible disc formats

The following disc formats can be used.

- Disc formats: CD-ROM Mode 1 and Mode 2
CD-ROM XA Mode 2, Form 1 and Form 2
- File formats: ISO9660 Level 1, Level 2, (Romeo, Joliet)
MP3 and WMA files written in any format other than those listed above may not play correctly, and their file names and folder names may not be displayed correctly.

Items related to standards and limitations are as follows:

- Maximum directory hierarchy: 8 levels (including the root)
- Maximum length of folder names/file names: 32 characters
- Maximum number of folders: 192 (including the root)
- Maximum number of files per disc: 255

- File names

The only files that can be recognized as MP3/WMA and played are those with the extension .mp3 or .wma.

- Discs containing multi-session recordings

As the audio system is compatible with multi-sessions, it is possible to play discs that contain MP3 and WMA files. However, only the first session can be played.

- ID3 and WMA tags

ID3 tags can be added to MP3 files, making it possible to record the track title, artist name, etc.

The system is compatible with ID3 Ver. 1.0, 1.1, and Ver. 2.2, 2.3 ID3 tags. (The number of characters is based on ID3 Ver. 1.0 and 1.1.)

WMA tags can be added to WMA files, making it possible to record the track title and artist name in the same way as with ID3 tags.

- MP3 and WMA playback

When a disc containing MP3 or WMA files is inserted, all files on the disc are first checked. Once the file check is finished, the first MP3 or WMA file is played. To make the file check finish more quickly, we recommend you do not write in any files other than MP3 or WMA files or create any unnecessary folders.

Discs that contain a mixture of music data and MP3 or WMA format data cannot be played.

- Extensions

If the file extensions .mp3 and .wma are used for files other than MP3 and WMA files, they may be mistakenly recognized and played as MP3 and WMA files. This may result in large amounts of interference and damage to the speakers.

● Playback

- To play MP3 files with steady sound quality, we recommend a fixed bit rate of at least 128 kbps and a sampling frequency of 44.1 kHz.
- CD-R or CD-RW playback may not be possible in some instances, depending on the characteristics of the disc.
- There is a wide variety of freeware and other encoding software for MP3 and WMA files on the market, and depending on the status of the encoding and the file format, poor sound quality or noise at the start of playback may result. In some cases, playback may not be possible at all.
- When files other than MP3 or WMA files are recorded on a disc, it may take more time to recognize the disc and in some cases, playback may not be possible at all.
- Microsoft, Windows, and Windows Media are the registered trademarks of Microsoft Corporation in the U.S. and other countries.

NOTICE

- **CDs and adapters that cannot be used (→P. 244)**
- **CD player precautions (→P. 245)**

3-3. Using the audio system

Using the DVD player (if equipped)

Insert a disc or press **DISC-ARM** with a disc inserted.

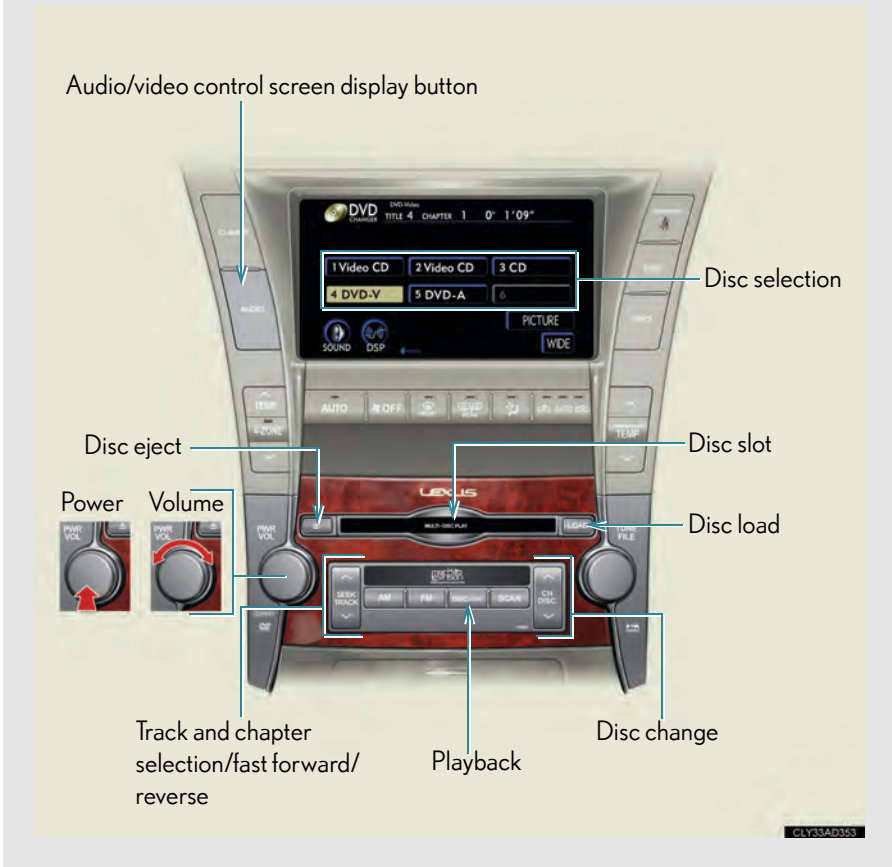

Loading a discs

■ Loading a single disc

STEP 1 Press **LOAD** .

STEP 2 When the indicator changes from flashing amber to green, insert a disc after the disc slot door opens.

■ Loading multiple discs

STEP 1 Press and hold **LOAD** until you hear a beep.

STEP 2 When the indicator changes from flashing amber to green, insert a disc after the disc slot door opens.

STEP 3 After inserting a disc, wait until the indicator changes from flashing amber to green, then insert the next disc after the disc slot door has opened.

STEP 4 Repeat steps 2 and 3 until you have inserted all discs.

To cancel the operation, press the **LOAD** or **DISC-AMP** button. If you do not insert a disc within 15 seconds, loading will be canceled automatically.

■ DVD hint screen



This screen appears when a DVD video, DVD audio or video CD is first selected with the “ENGINE START STOP” switch in ACCESSORY or IGNITION ON mode.

Touch **OK** once you have read the message.

Ejecting discs

Ejecting a disc

STEP 1 To select the disc to be ejected, touch the desired disc on the screen or press \wedge or \vee on .

STEP 2 Press  and remove the disc.

Ejecting all discs

Press and hold  until you hear a beep, then remove the discs.

Selecting a disc

To select a disc to play



Touch the desired disc on the screen or press \wedge or \vee on .

- Audio CD, CD text → P. 238
- MP3/WMA disc → P. 246
- DVD video/audio → P. 257
- Video CD → P. 270

3-3. Using the audio system

Playing DVD video/audio

For safety reasons, you can enjoy the visual contents of discs only when the vehicle is completely stopped with the “ENGINE START STOP” switch in ACCESSORY or IGNITION ON mode and the parking brake applied. While you are driving, only audio contents may be played.

When a DVD video disc or DVD audio disc is inserted while driving, the main story will automatically be played. However, some discs may not be played automatically.

Insert a disc or press  with a disc inserted.

■ Video control screen

Press  while the disc is playing, and the following screen appears.

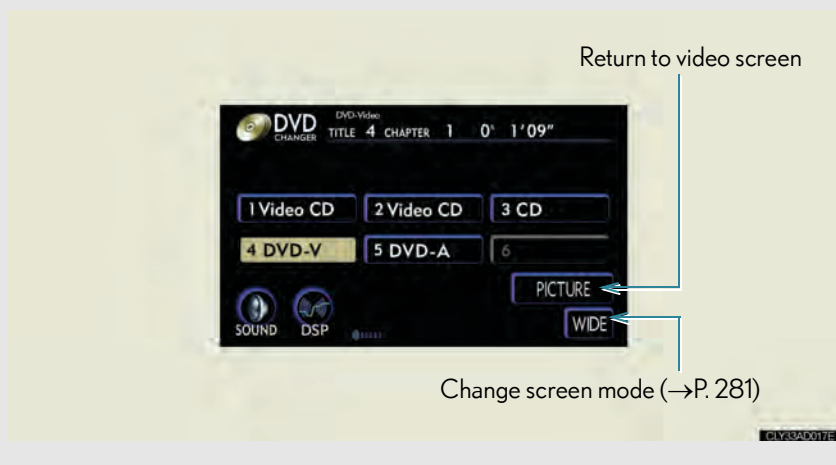

■ Control icon screen

Touch any part of the screen if no icons are shown while watching a video, and the following screen appears.

▶ DVD video mode

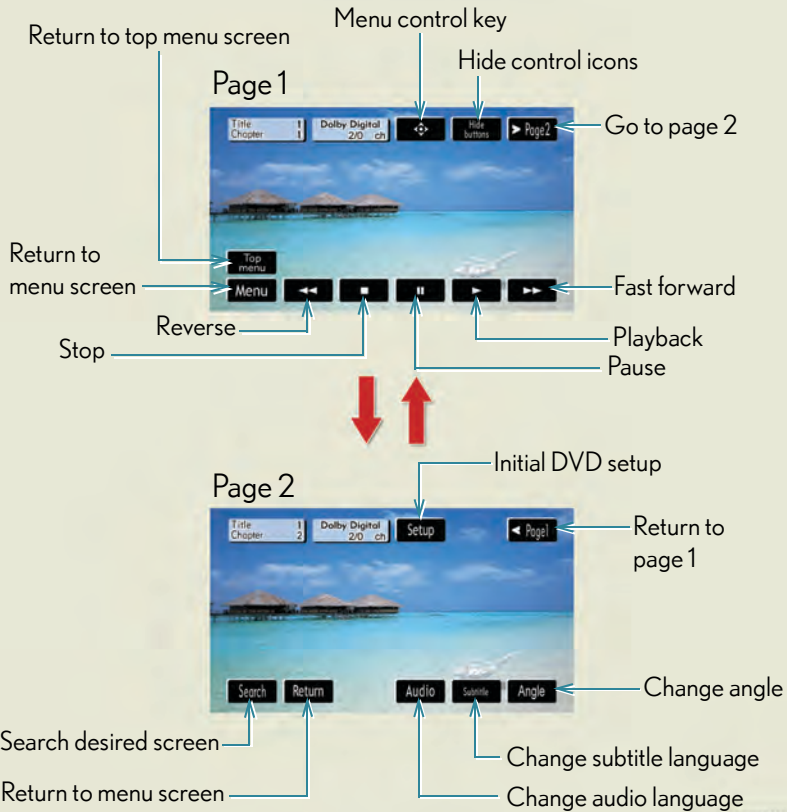

If  appears on the screen when you touch an icon, the operation relevant to that control is not permitted.

▶ DVD audio mode

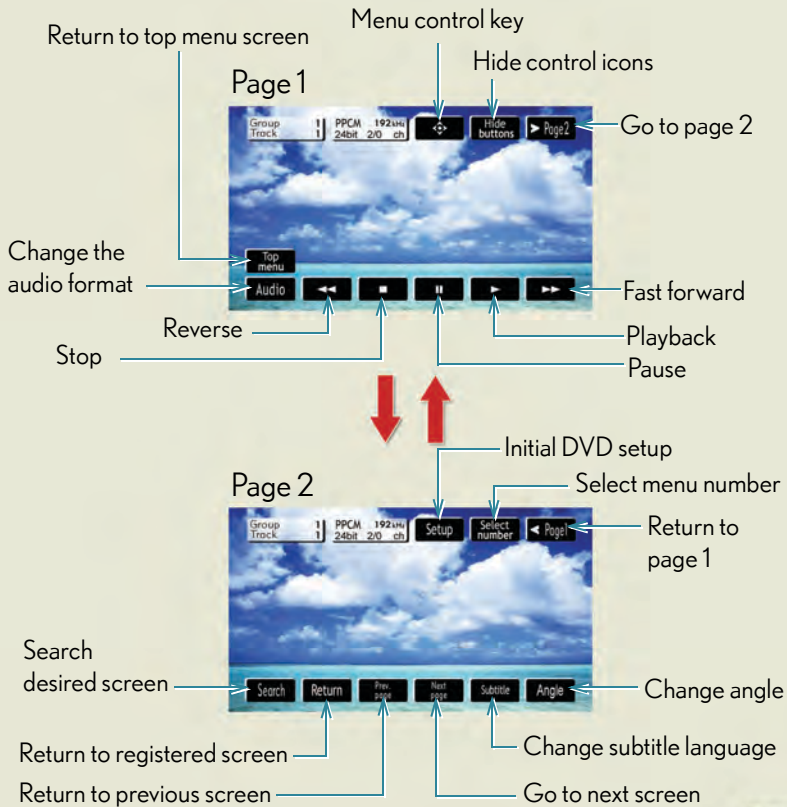



If  appears on the screen when you touch an icon, the operation relevant to that control is not permitted.

Loading, ejecting and selecting discs

→P. 255

Fast forwarding/reversing a disc

Touch and hold  or  on the screen or press and hold \wedge or \vee

on  until you hear a beep.

Slow playback

Touch  and then touch . Video is played slowly while you are touching .

Searching a desired screen

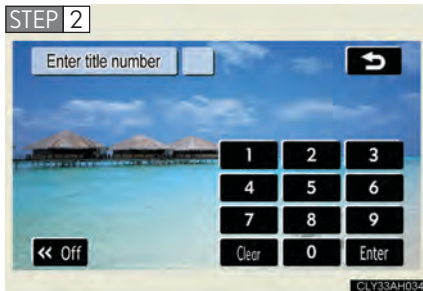

■ Searching by title (DVD video mode)

STEP 1 Touch  on the control icon screen.



Input the desired title number and then touch .

 **Clear**: deletes the last input number.

 **Off**: hides the icons. To display the icons, touch .

 **Return**: returns to the previous screen.

■ Searching by group (DVD audio mode)

STEP 1 Touch **Search** on the control icon screen.

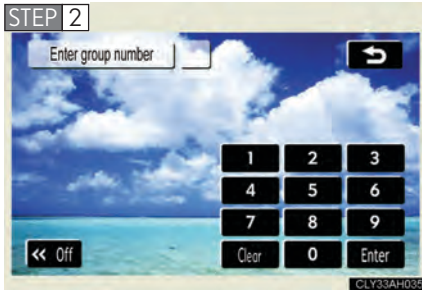

Input the group number and then touch **Enter**.

Clear: deletes the last input number.

<< Off: hides the icons. To display the icons, touch **>> On**.

↶: returns to the previous screen.

■ Playing a bonus group (DVD audio mode only, if the DVD has bonus options)

STEP 1 Touch **Search** on the control icon screen.

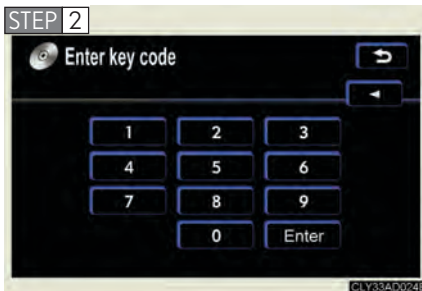

Input the desired bonus group number on the group search screen and touch **Enter**.

<: deletes the number.

↶: returns to the previous screen.

■ Searching by chapter/track

Press **^** or **v** on **SEEK TRACK** to select a chapter/track.



■ **Selecting a menu number (DVD audio mode only)**

STEP 1 Touch **Select number** on the control icon screen.

STEP 2

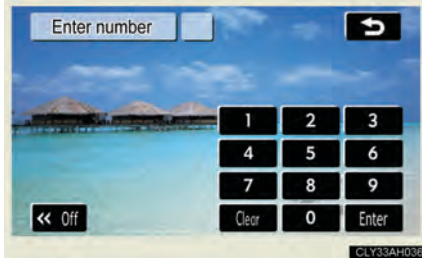

Input the desired menu number on the screen and touch **Enter**.

Using the DVD menu

STEP 1 Touch **Menu** or **Top menu** on the control icon screen.

Touch **Menu** if the menu control key does not appear on the menu screen.

STEP 2

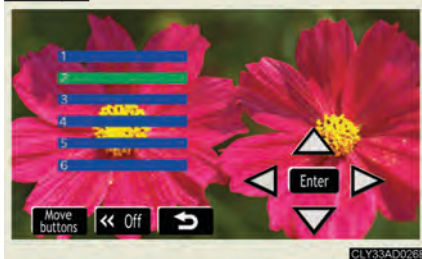

Touch **▲**, **▼**, **◀** or **▶** to select a menu item, then touch **Enter** to select.

Move buttons: moves icons up or down.

<< Off: hides icons. To display icons, touch **>> On**.

Back: returns to the previous screen.

Note that specific items or the operating method differs from one DVD to another. Refer to the manual that comes with the DVD disc. (The above image is an example.)

Changing the subtitle language

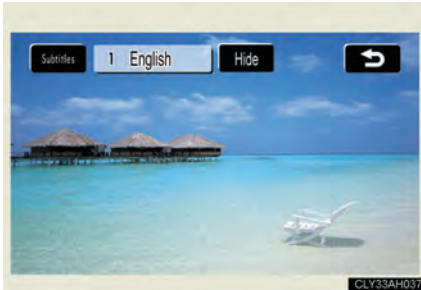

Touch **Subtitles** on the control icon screen.

Each time you touch the switch, the next available language is selected.

Hide: hide the control subtitle.

↩: returns to the previous screen.

Changing the audio language (DVD video only)

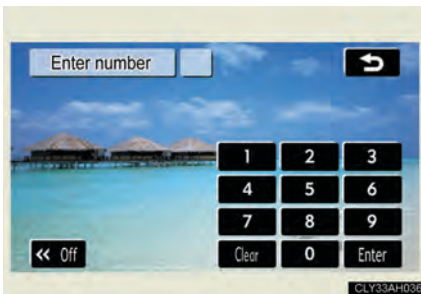

Touch **Audio** on the control icon screen.

Each time you touch the switch, the next available language is selected.

↩: returns to the previous screen.

Changing the audio format (DVD audio only)



Touch **Audio** on the control icon screen.

Each time you touch the switch, the next available audio format is selected.

↩: returns to the previous screen.

Changing the angle (If the angle option is available)

STEP 1 Touch **Angle** on the control icon screen.

STEP 2



Touch **Angle**.

Each time you touch the switch, the next available angle is selected.

: returns to the previous screen.

Initial DVD setup

■ Displaying “Setup menu” screen

STEP 1 Touch **Setup** on the control icon screen.

STEP 2



After you change the initial settings, touch **Enter**.

: restores default settings.

■ Setting audio language

STEP 1 Touch **Audio language** on the “Setup menu” screen.

STEP 2 Select the desired language.

If you cannot find the desired language, touch **Others** and input the desired language code. (→P. 267)

↩: returns to the previous screen.

■ Setting subtitle language

STEP 1 Touch **Subtitle language** on the “Setup menu” screen.

STEP 2 Select the desired language.

If you cannot find the desired language, touch **Others** and input the desired language code. (→P. 267)

↩: returns to the previous screen.

■ Setting menu language

STEP 1 Touch **DVD language** on the “Setup menu” screen.

STEP 2 Select the desired language.

If you cannot find the desired language, touch **Others** and input the desired language code. (→P. 267)

↩: returns to the previous screen.

■ Setting angle mark On or Off

If the DVD has angle options, you can turn the angle mark on or off.

Touch **Angle mark** on the “Setup menu” screen. Each time you touch the switch, the multi angle mark on the screen turns on or off alternately.

■ Parental lock

STEP 1 Touch **Parental lock** on the “Setup menu” screen.

STEP 2



Input the 4-digit personal code and then touch **Enter**.

If you enter wrong numbers, touch **←** to delete the numbers.

Touch **←** 10 times to reset the personal code.

STEP 3 Select a parental level (1 - 8). (→P. 276)

↩: returns to the previous screen.

■ Entering a language code

If you touch **Others** on the “Select audio language” screen, “Select subtitle language” screen or “Select DVD language” screen, you can select a language by entering the 4-digit language code if that language is available.

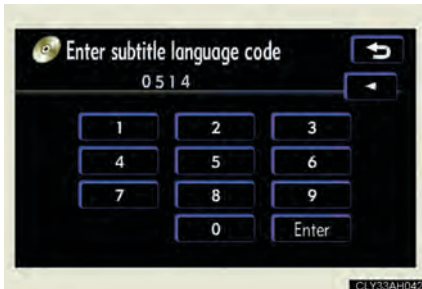

Input the 4-digit language code and then touch **Enter**.

←: deletes the last input digit.

↩: returns to the previous screen.

● Language codes

Code	Language	Code	Language	Code	Language
0514	English	0207	Bulgarian	0712	Galician
0618	French	0208	Bihari	0714	Guarani
0405	German	0209	Bislama	0721	Gujarati
0920	Italian	0214	Bengali	0801	Hausa
0519	Spanish	0215	Tibetan	0809	Hindi
2608	Chinese	0218	Breton	0818	Croatian
1412	Dutch	0301	Catalan	0821	Hungarian
1620	Portuguese	0315	Corsican	0825	Armenian
1922	Swedish	0319	Czech	0901	Interlingua
1821	Russian	0325	Welsh	0905	Interlingue
1115	Korean	0401	Danish	0911	Inupiak
0512	Greek	0426	Bhutani	0914	Indonesian
0101	Afar	0515	Esperanto	0919	Icelandic
0102	Abkhazian	0520	Estonian	0923	Hebrew
0106	Afrikaans	0521	Basque	1001	Japanese
0113	Amharic	0601	Persian	1009	Yiddish
0118	Arabic	0609	Finnish	1023	Javanese
0119	Assamese	0610	Fiji	1101	Georgian
0125	Aymara	0615	Faroese	1111	Kazakh
0126	Azerbaijani	0625	Frisian	1112	Greenlandic
0201	Bashkir	0701	Irish	1113	Cambodian
0205	Byelorussian	0704	Scots-Gaelic	1114	Kannada

Code	Language	Code	Language	Code	Language
1119	Kashmiri	1415	Norwegian	1914	Shona
1121	Kurdish	1503	Occitan	1915	Somali
1125	Kirghiz	1513	(Afan) Oromo	1917	Albanian
1201	Latin	1518	Oriya	1918	Serbian
1214	Lingala	1601	Panjabi	1919	Siswati
1215	Laothian	1612	Polish	1920	Sesotho
1220	Lithuanian	1619	Pashto, Pushto	1921	Sundanese
1222	Latvian	1721	Quechua	1923	Swahili
1307	Malagasy	1813	Rhaeto- Romance	2001	Tamil
1309	Maori	1814	Kirundi	2005	Telugu
1311	Macedonian	1815	Romanian	2007	Tajik
1312	Malayalam	1823	Kinyarwanda	2008	Thai
1314	Mongolian	1901	Sanskrit	2009	Tigrinya
1315	Moldavian	1904	Sindhi	2011	Turkmen
1318	Marathi	1907	Sangho	2012	Tagalog
1319	Malay	1908	Serbo- Croatian	2014	Setswana
1320	Maltese	1909	Sinhalese	2015	Tonga
1325	Burmese	1911	Slovak	2018	Turkish
1401	Nauru	1912	Slovenian	2019	Tsonga
1405	Nepali	1913	Samoan	2020	Tatar

Code	Language	Code	Language	Code	Language
2023	Twi	2209	Vietnamese	2515	Yoruba
2111	Ukrainian	2215	Volapük	2621	Zulu
2118	Urdu	2315	Wolof		
2126	Uzbek	2408	Xhosa		

■ Error messages

If “Region code error” is displayed, check the region code printed on the DVD matches the player’s region code.

If a different message is displayed: →P. 242

3-3. Using the audio system

Playing a video CD

For safety reasons, you can enjoy the visual contents of discs only when the vehicle is completely stopped with the “ENGINE START STOP” switch in ACCESSORY or IGNITION ON mode and the parking brake applied. While you are driving, only audio contents may be played.

Insert a disc or press  with a disc inserted.

■ Video control screen

Press  while the disc is playing, and the following screen appears.

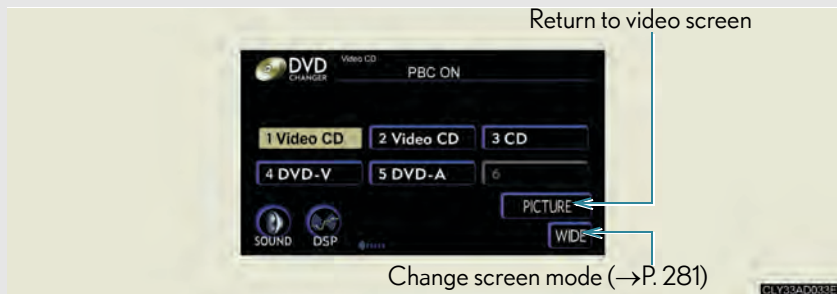

Control icon screen

Touch any part of the screen if no icons are shown while watching a video CD, and the following screen appears.

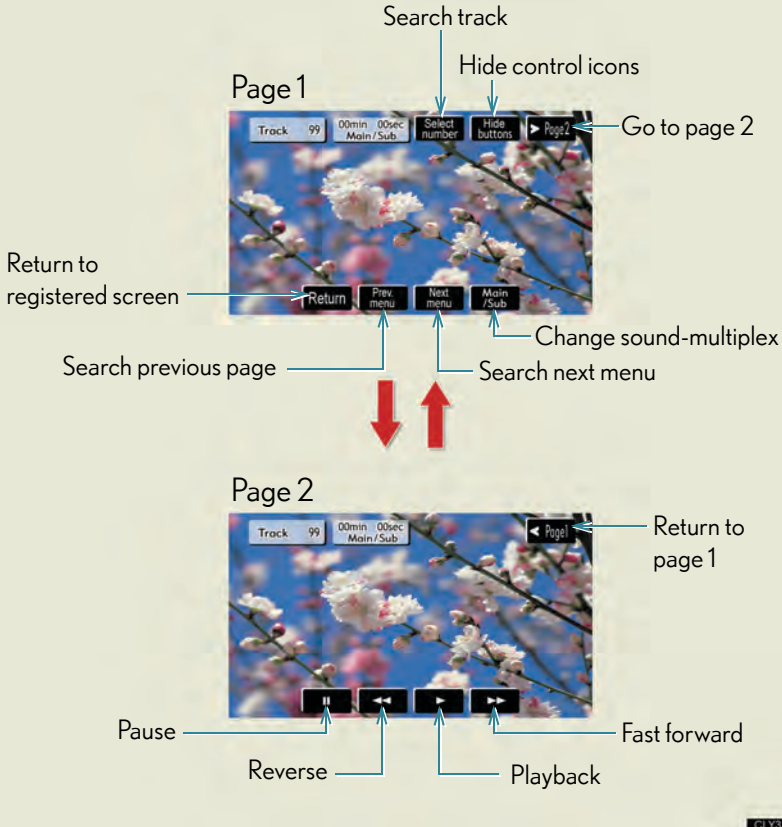

If  appears on the screen when you touch an icon, the operation relevant to that control is not permitted.

Loading, ejecting and selecting discs

→P. 255

Fast forwarding/reversing a video CD

Touch and hold  or  on the control icon screen or press

and hold \wedge or \vee on  until you hear a beep.

Slow playback

Touch  and then touch  on the control icon screen.

Video is played slowly while you are touching .

Using the video CD menu

Touch  on the control icon screen.

Refer to the manual that comes with the video CD for specific menu items.

Selecting a desired screen

■ Searching manually

Touch **Prev. menu** or **Next menu** on the screen, or press \wedge or \vee on  until the desired screen appears.

■ Searching by number

STEP 1 Touch **Select number** on the control icon screen.

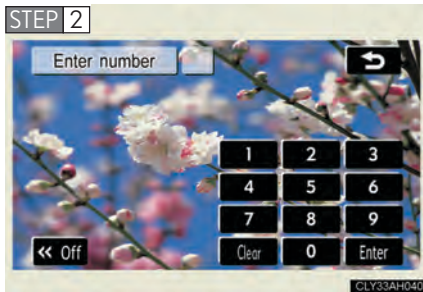

Input the desired track number on the screen and touch **Enter**.

- Clear**: deletes the last input number.
- << Off**: hides icons. To display icons, touch **>> On**.
- ↶**: returns to the previous screen.

Changing the sound-multiplex mode

Touch **Main/Sub** on the control icon screen. The mode cycles through each time the switch is touched.

“Main” → “Sub” → “Main/Sub”

■ Error messages







→P. 242

DVD player and DVD video disc information

■ DVD video discs

- The DVD player conforms to PAL color TV formats.
- Region code: Some DVD video discs have a region code indicating the region in which you can use the DVD video disc. If the DVD video disc is not labeled as "ALL" or "4", you cannot use it on this DVD player. If you attempt to play an inappropriate DVD video disc on this player, "Region code error" appears on the screen. Even if the DVD video disc does not have a region code, you may not be able to use it.

■ Symbols shown on DVD video discs

Symbol	Meaning
	Indicates PAL format.
	Indicates the number of audio tracks.
	Indicates the number of language subtitles.
	Indicates the number of angles.
	Indicates the screen display ratios available. Wide screen: 16:9 Standard: 4:3
	Indicates the disc's region code. ALL: in all countries Number: region code

■ Discs that can be used

Discs with the marks shown below can be used.

Playback may not be possible depending on recording format or disc features, or due to scratches, dirt or deterioration.



CDs with copy-protection features may not play correctly.

■ DVD player protection feature

To protect the internal components, playback is automatically stopped when a problem is detected while the DVD player is being used.

■ If discs are left inside the DVD player or in the ejected position for extended periods

Discs may be damaged and may not play properly.

■ Lens cleaners

Do not use lens cleaners. Doing so may damage the DVD player.

■ DVD video disc information

● DVD video discs

A DVD video disc is a Digital Versatile Disc that holds video. Digital Versatile Disc that holds video. DVD video discs have adopted "MPEG2", one of the world standards of digital compression technologies. The picture data is compressed by 1/40 on average and stored. Variable rate encoded technology in which the volume of data assigned to the picture is changed depending on the picture format has also been adopted. Audio data is stored using PCM and Dolby digital, which enables higher quality of sound. Furthermore, multi-angle and multi-language features will also help you enjoy the more advanced technology of DVD video.

- Viewer restrictions

This feature limits what can be viewed in conformity with the level of restrictions of the country. The level of restrictions varies depending on the DVD video disc. Some DVD video discs cannot be played at all, or violent scenes are skipped or replaced with other scenes.

Level 1: DVD video discs for children can be played.

Level 2-7: DVD video discs for children and G-rated movies can be played.

Level 8: All types of DVD video discs can be played.

- Multi-angle option

You can enjoy the same scene from different angles.

- Multi-language option

You can select the subtitle and audio languages.

- Region codes

The region codes are provided on DVD players and DVD discs. If the DVD video disc does not have the same region code as the DVD player, you cannot play the disc on the DVD player. (→P. 274)

- Audio

This DVD player can play linear PCM, Dolby Digital and MPEG audio format DVDs. Other decoded types cannot be played.

- Title and chapter

Video and audio programs stored in DVD video discs are divided into parts by title and chapter.

Title: The largest unit of the video and audio programs stored on DVD video discs. Usually, one movie, one album, or one audio program is assigned as a title.

Chapter: A title is comprised of one or more chapters.

■ Sound

● Dolby Digital

Manufactured under license from Dolby Laboratories.

“Dolby”, “Pro Logic”, and the double-D symbol are trademarks of Dolby Laboratories. Confidential unpublished works.

©1992-1997 Dolby Laboratories. All rights reserved.

This product incorporates copyright protection technology that is protected by method claims of certain U. S. patents and other intellectual property rights owned by Macrovision Corporation and other rights owners. Use of this copyright protection technology must be authorized by Macrovision Corporation, and is intended for home and other limited viewing uses only unless otherwise authorized by Macrovision Corporation.

Reverse engineering or disassembly is prohibited.

● DTS

“DTS” and “DTS Digital Surround” are registered trademarks of Digital Theater System, Inc.

CAUTION

■ DVD video precaution

Conversational speech on some DVDs is recorded at a low volume to emphasize the impact of sound effects. If you adjust the volume assuming that the conversations represent the maximum volume level that the DVD will play, you may be startled by louder sound effects or when you change to a different audio source.

Loud sounds may have a significant impact on the human body or pose a driving hazard. Keep this in mind when you adjust the volume.

NOTICE

■ Unsuitable discs, and player precautions

→P. 244

3-3. Using the audio system

Optimal use of the audio/video system

Press  to display the audio/video control screen.

► Operating the radio and audio CD

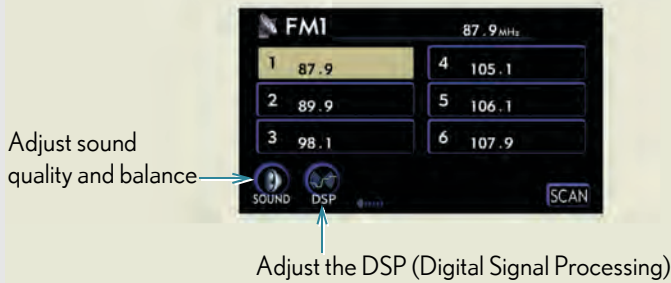

► Operating the DVD video/audio and video CD

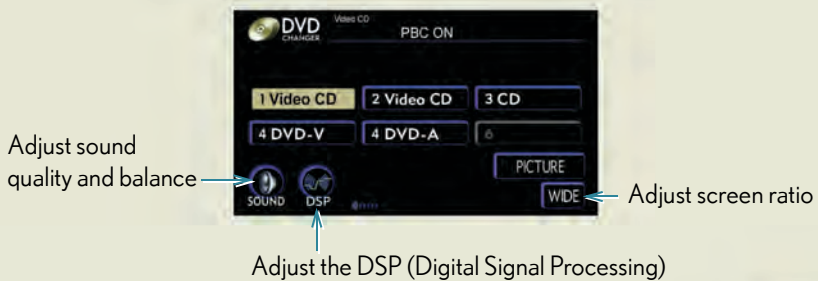





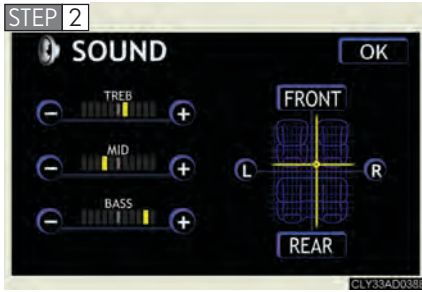



Adjusting sound quality and balance

STEP 1 Touch  on the screen.

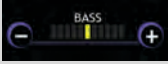
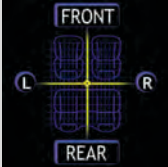

Adjust the settings, referring to the following table.

Once you have finished, touch .

Sound quality mode	Display	Level	Touch
High-pitched tones*		-5 to 5	 or 
Mid-pitched tones*		-5 to 5	
Low-pitched tones*		-5 to 5	
Front/rear volume balance		F7 to R7	 or 
Left/right volume balance		L7 to R7	 or 

*: The sound quality level is adjusted individually in each radio, CD or DVD mode.

Setting DSP (Digital Signal Processing)

The following features can be set as desired by touching  on the screen.



■ Turning Automatic Sound Levelizer (ASL) ON or OFF

Touch  or .



ASL automatically adjusts the volume and tone quality according to the noise level as you drive your vehicle.



■ Changing the listening position (with CD player only)

The speaker balance can be changed to produce the best sound for each listening position.

Touch .

The listening position changes as follows each time the switch is touched.

Display	Listening position
	Position best suited to the driver's seat
	Position best suited to the driver's and front passenger's seats

Display	Listening position
	Position best suited to the rear seats
	Position best suited to all seats

■ Turning the surround ON or OFF (with DVD player only)

Touch **ON** or **OFF**.

Setting the screen ratio mode (with DVD player only)

STEP 1 Touch **WIDE** on the screen.



Touch one of **NORMAL**, **WIDE1** or **WIDE2** to match the screen ratio printed on the DVD.

Screen ratio mode	Details
NORMAL	Suitable for 4:3 screen ratio
WIDE1	Expands the normal screen horizontally to fill the display
WIDE2	Suitable for 16:9 screen ratio

3-3. Using the audio system

Using the AUX adapter

This adapter can be used to connect a portable audio device and listen to it through the vehicle's speakers.

STEP 1



Connect the portable audio device.

STEP 2 Press  .

■ Operating portable audio devices connected to the audio system

The volume can be adjusted using the vehicle's audio controls. All other adjustments must be made on the portable audio device itself.

■ When using a portable audio device connected to the power outlet

Noise may occur during playback. Use the power source of the portable audio device.

3-3. Using the audio system

Using the rear seat audio controls (if equipped)

Some front audio features can be controlled from the rear seats.

► 5-seat models

Volume UP/DOWN

Selecting a folder

Power ON/OFF

Selecting a disc



Selecting an audio source

Radio: Selecting a station
Audio CD or DVD audio: Selecting a track
Video CD or DVD video: Selecting a chapter
MP3 CD or WMA CD: Selecting a file

CLY33AH058

▶ 4-seat models

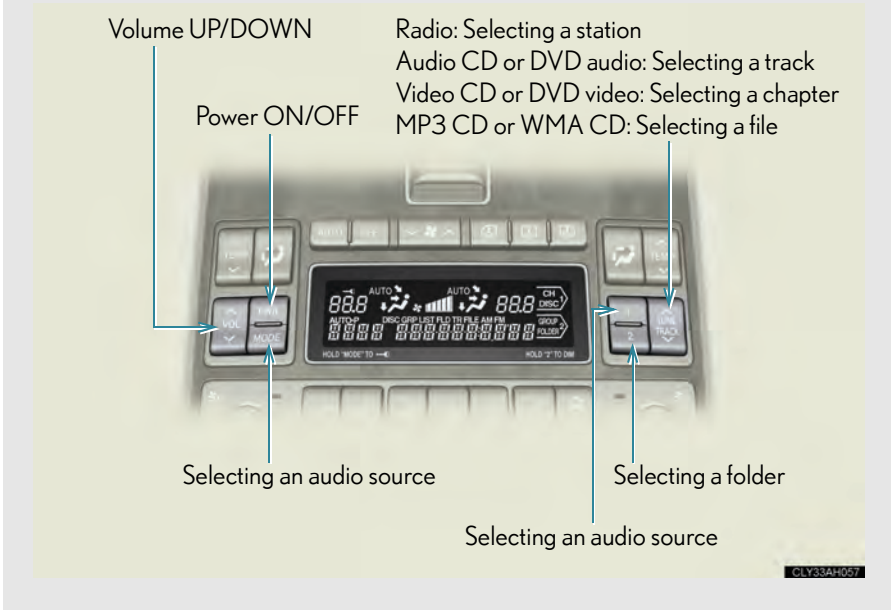

Turning the power

Press **PWR** to turn the front audio system on.

Pressing the button again turns the system off.

Changing the audio source

Press  to change the audio source.

The audio source changes as follows each time the button is pressed. If a CD or DVD is not inserted, that mode will be skipped.

With CD player: AM→FM1→FM2→CD changer→AUX→AM

With DVD player: AM→FM1→FM2→DVD changer→AUX→AM

Adjusting the volume

Press \wedge on  to increase the volume and \vee to decrease the volume.

Press and hold the button to continue increasing or decreasing the volume.

Selecting a radio station

STEP 1 Press  to select a frequency band.

STEP 2 Press \wedge or \vee on  to select a radio station.

To scan for receivable stations, press and hold the button until you hear a beep.

Selecting a track (audio CD)

STEP 1 Press  to select the CD changer.

STEP 2 Press  (DISC) to select a disc.

STEP 3 Press \wedge or \vee on  to select a track.

Selecting a track (audio CD or DVD audio) or chapter (video CD or DVD video)

STEP 1 Press  to select the DVD changer.

STEP 2 Press  (DISC) to select a disc.

STEP 3 Press \wedge or \vee on  to select a track or chapter.

Selecting a file (MP3 CD or WMA CD)

STEP 1 Press  to select the CD changer or DVD changer.

STEP 2 Press  (DISC) to select a disc.

STEP 3 Press  (FOLDER) to select a folder.

STEP 4 Press \wedge or \vee on  to select a file.

■ Button lock function

To prevent inadvertent operation, some buttons on the rear armrest can be locked. (→P. 226)

■ Rear control panel illumination off function

Control panel illumination on the rear armrest can be turned off. (→P. 227)

■ When ERROR, WAIT or NO MUSIC is shown on the display

(→P. 242)

Using the steering wheel audio switches

Some audio features can be controlled using the switches on the steering wheel.



- 1** Turns the power on, select audio source
- 2** Volume
- 3** Radio mode: Select radio stations
CD mode: Select tracks, files (MP3 and WMA) and discs
DVD mode: Selects tracks, chapter and discs

Turning on the power

Press  when the audio system is turned off.

The audio system can be turned off by holding the switch down for 1 second or more.



Changing the audio source

Press  when the audio system is turned on. The audio source changes as follows each time the switch is pressed. If a CD or DVD is not inserted, that mode will be skipped.

With CD player: AM→FM1→FM2→CD changer→AUX→AM

With DVD player: AM→FM1→FM2→DVD changer→AUX→AM

Adjusting the volume

Pull  to increase the volume and  to decrease the volume.

Hold up the switch to continue increasing or decreasing the volume.

Selecting a radio station

STEP 1 Press  to select the radio mode.

STEP 2 Press \wedge or \vee on  to select a radio station.

To scan for receivable stations, press and hold \wedge or \vee on the switch until you hear a beep.

Selecting a track/file or chapter

STEP 1 Press  to select the CD or DVD mode.

STEP 2 Press \wedge or \vee on  to select the desired track/file or chapter.

Selecting a disc in the CD or DVD changer

STEP 1 Press  to select the CD or DVD mode.

STEP 2 Press and hold \wedge or \vee on  until a beep is heard.

■ Canceling automatic selection of a radio station

Press the same switch.

CAUTION

■ To reduce the risk of an accident

Exercise care when operating the audio switches on the steering wheel.

3-4. Using the rear seat entertainment system

Rear seat entertainment system features (if equipped)

The rear seat entertainment system is designed for the rear passengers to enjoy audio and DVD video separately from the front audio system.

► 5-seat models



1 Front audio system

2 Display

3 Rear seat entertainment system controller

4 A/V input adapter

► 4-seat models

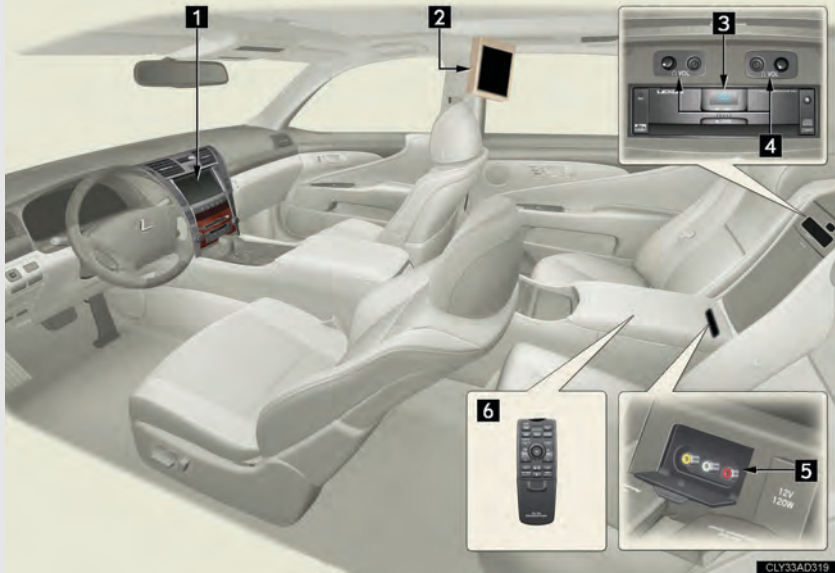

- 1 Front audio system
- 2 Display
- 3 DVD player
- 4 Headphone volume control dials and headphone jacks
- 5 A/V input adapter
- 6 Rear seat entertainment system controller

Rear seat entertainment system controller



To use the buttons under the cover, slide the cover down.

Opening and closing the display

Opening and closing the display



● Open

Press **CLOSE** **OPEN**, **DVD**, **VIDEO** or **▶ ||**.

● Close

Press **CLOSE** **OPEN** or **OFF**.

If the display is closed with an image shown, the image will automatically turn off. (The sound will not be turned off.)

Opening and closing operations can be performed from the front seat. (→P. 200)

■ Tilting the display

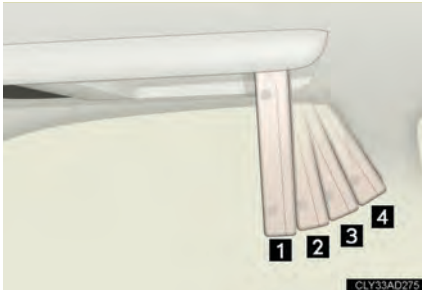

The display angles change as follows each time **TILT** is pressed.

1 → **2** → **3** → **4** → **1**

The display angle is memorized and will be recalled when the "ENGINE START STOP" switch is turned to ACCESSORY or IGNITION ON mode again.

■ Caution screen



This screen appears for a few seconds when the rear display is opened. During this time, only



can be operated.

Headphone jacks (if equipped)

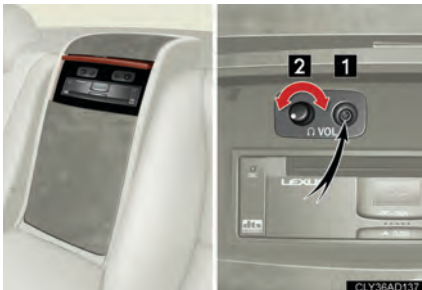

To listen to the rear audio, use headphones.

1 To use the headphones
Connect them to the jack.

2 To adjust the volume
Turn the knob clockwise to increase the volume. Turn the knob counterclockwise to decrease the volume.

Changing the source



Press **SOURCE** to display the audio source selection screen.



Select an audio source.

Changing the speaker output



To play the rear audio over the speakers in the vehicle, turn

Speaker Output on.

■ The rear seat entertainment system can be used when

The “ENGINE START STOP” switch is in the ACCESSORY or IGNITION ON mode.

■ Jam protection function

The display will stop closing and return to its previous position if something gets in the way of it closing.

■ When appears on the screen

It indicates that the selected icon cannot be used at this time.

■ Rear system lock

→P. 201

■ Before using the controller (for new vehicle owners)



An insulating sheet is set to prevent the batteries from being depleted. Remove the insulating sheet before using the remote control.

■ When the controller batteries are fully depleted



Remove the depleted batteries and install new batteries.

■ Headphones

With some headphones generally available in the market, it may be difficult to catch signals properly. Lexus recommends the use of Lexus genuine wireless headphones.

Contact your Lexus dealer for further details.

■ Volume

- Adjust the volume when you connect the headphones to the jack. Loud sounds may have a significant impact on the human body.
- Conversational speech on some DVDs is recorded at a low volume to emphasize the impact of sound effects. If you adjust the volume assuming that the conversations represent the maximum volume level that the DVD will play, you may be startled by louder sound effects or when you change to a different audio source. Be sure to adjust the volume with this in mind.

CAUTION

■ When the rear seat entertainment system is not used

Keep the display closed.

In the event of an accident or sudden braking, an occupant may hit the opened display, resulting in injury.

■ To prevent accidents and electric shock

Do not disassemble or modify the remote control.

■ When the remote controller is not used

Stow the remote controller.

Injuries may result in the event of an accident or sudden braking.

■ Closing the display

Never use any part of your body to intentionally activate the jam protection function.

 NOTICE

■ **Cleaning the display**

Wipe the display with a dry soft cloth.

If the screen is wiped with a rough cloth, the surface of the screen may be scratched.

■ **To prevent damage to the remote control**

- Keep the remote control away from direct sunlight, high temperature and high humidity.
- Do not drop or knock the remote control against hard objects.
- Do not sit on or place heavy objects on the remote control.

■ **DVD player**

Never try to disassemble or oil any part of the DVD player. Do not insert anything other than a disc into the slot.

■ **Closing the display**

Do not close the display using your hand. Doing so may result in a malfunction.

3-4. Using the rear seat entertainment system

Using the radio





Select radio mode on the source screen to display the control screen.

Selecting a preset station

Press \wedge or \vee on  until the desired station band appears on the screen.

Tuning the station

Press \wedge or \vee on  until the desired station appears on the screen.

Press \wedge or \vee on  and the stations will be searched automatically one after another.

3-4. Using the rear seat entertainment system

Using the front DVD changer



- 1 Turning on DVD changer mode
- 2 Selecting a disc

Selecting a disc



Press \wedge or \vee on  until the desired slot number appears on the screen.

- Audio CD, CD text → P. 238
- MP3/WMA disc → P. 246
- DVD video/audio → P. 254
- Video CD → P. 270

3-4. Using the rear seat entertainment system

Using the rear DVD player (if equipped)

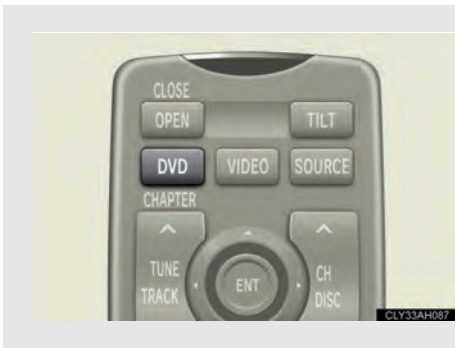

Press **DVD** or select “Rr-DVD” on the source screen to display the control screen.

Loading a disc

STEP 1



Open the cover.

STEP 2



Insert the disc into the slot with the label side up.

The DISC indicator light turns on while the disc is loaded.

The player will play the track or chapter, and will repeat it after it reaches the end.

STEP 3 Close the cover.

Ejecting a disc

STEP 1



Open the cover.

STEP 2



Press  and remove the disc.

STEP 3 Close the cover.

Playing a disc



- Audio CD, CD text →P. 301
- MP3 disc →P. 302
- DVD video/audio →P. 303
- Video CD →P. 316

The rear DVD player cannot play WMA files.

3-4. Using the rear seat entertainment system

Playing an audio CD/CD text

■ Selecting a track



Press \wedge or \vee on  until the desired track number appears on the screen.

■ Fast forwarding or reversing a track

Press and hold \wedge or \vee on



3-4. Using the rear seat entertainment system

Playing WMA (front DVD changer only)/MP3 discs

■ Selecting a file



Press \wedge or \vee on  until the desired file number appears on the screen.

■ Selecting a folder

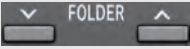
Press \wedge or \vee on  until the desired folder number appears on the screen.

■ Fast forwarding or reversing a file

Press \wedge or \vee on .

3-4. Using the rear seat entertainment system

Playing a DVD video/audio

■ Controller



- 1 Turning on the DVD mode
- 2 Selecting a chapter/track
- 3 Reversing a disc
- 4 Turning on the title selection screen
- 5 Changing the subtitle language
- 6 Turning on the control icon screen
- 7 Changing the audio language
- 8 Stopping a disc
- 9 Turning on the menu disc
- 10 Fast forwarding a disc
- 11 Playing/pausing a disc
- 12 Selecting an icon
- 13 Inputting the selected icon

■ **Control icon screen**

Press **OPTION** if no icons are shown while watching DVD video, and the following screen appears.

● **DVD video mode**

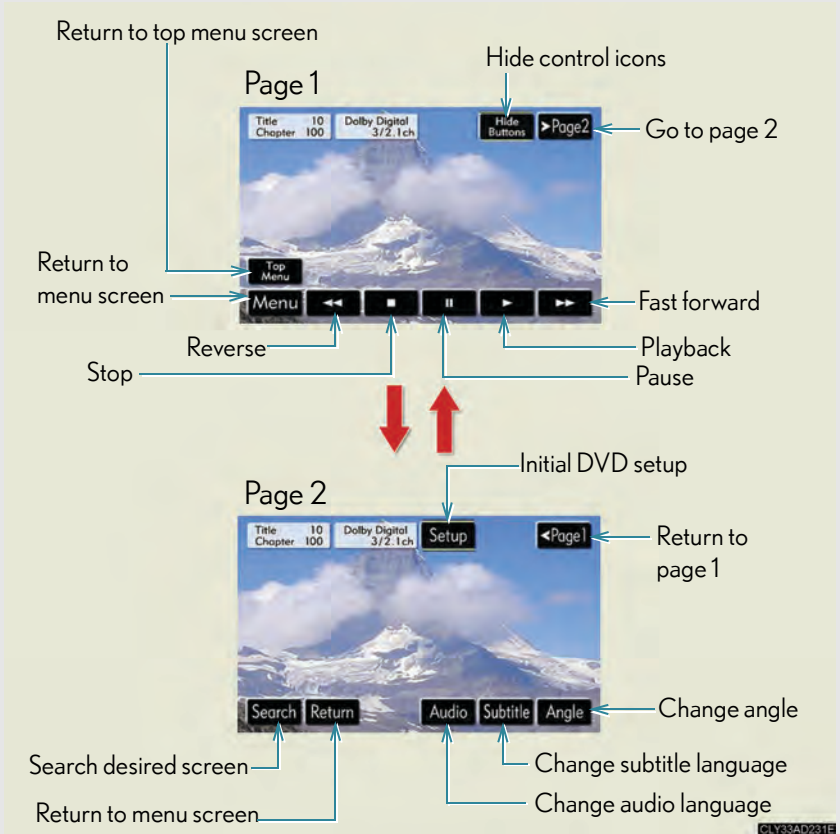

If **⊘** appears on the screen when you select an icon, the operation relevant to that control is not permitted.

● DVD audio mode

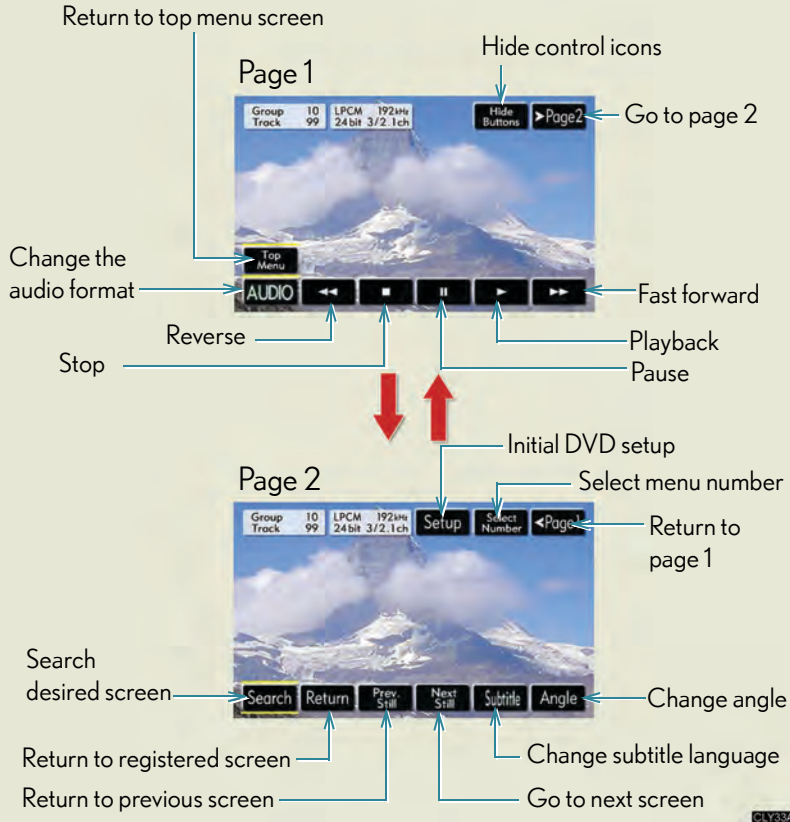



If  appears on the screen when you select an icon, the operation relevant to that control is not permitted.

Turning on or off the control icons



Press  to turn on the control icons.

Press  once again or select  to turn off the control icons.

Turning on the title selection screen



Press  or select  to turn on the title selection screen. For the operation of the title selection screen, see the separate manual for the DVD disc.



Turning on the menu screen (DVD video mode only)

Press  or select  to turn on the menu screen. For the operation of the menu screen, see the separate manual for the DVD disc.

Fast forwarding/reversing a disc

Perform either of the following

● Select  or  on the screen by pressing and holding .

● Press and hold  or  on .

Slow playback

Select  and then select . Video is played slowly when you select  by pressing and holding .

Returning to the previous screen

Select **Return** to return to the previous screen. For the operation of the menu screen, see the separate manual for the DVD disc.

Searching a desired screen

■ Searching by title (DVD video mode)

STEP 1 Select **Search** on the control icon screen.

STEP 2

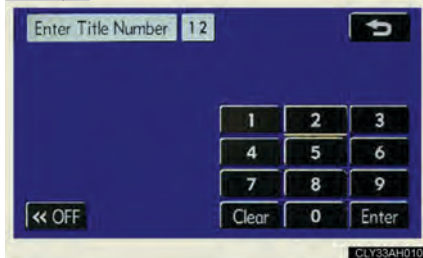

Input the desired title number and then select **Enter**.

Clear: deletes the last input number.

<< OFF: hides the icons. To display the icons, select **>> ON**.

↩: returns to the previous screen.

■ Searching by group (DVD audio mode)

STEP 1 Select **Search** on the control icon screen.

STEP 2



Input the group number and then select **Enter**.

Clear: deletes the last input number.

<< OFF: hides the icons. To display the icons, select **>> ON**.

↩: returns to the previous screen.

■ **Playing a bonus group (DVD audio mode only, if the DVD has bonus options)**

STEP 1 Select **Search** on the control icon screen.

STEP 2



Input the desired bonus group number on the group search screen and select **Enter**.

 : deletes the number.

 : returns to the previous screen.

■ **Searching by chapter/track**

Press \wedge or \vee on  to select a chapter/track.

■ **Selecting a menu number (DVD audio mode only)**

STEP 1 Select **Select Number** on the control icon screen.

STEP 2



Input the desired menu number on the screen and select **Enter**.

Changing the subtitle language

STEP 1 Press **SUB TITLE** or select **Subtitle** on the control icon screen.

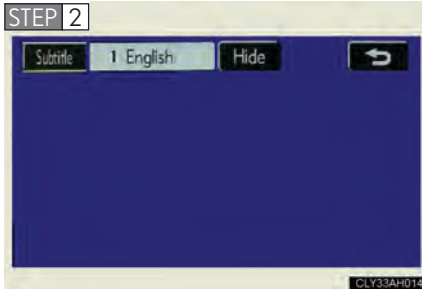

Select **Subtitle**.

Each time you press **ENT**, the next available language is selected.

Hide: hide the subtitle.

↩: returns to the previous screen.

Changing the audio language (DVD video only)

STEP 1 Press **AUDIO** or select **Audio** on the control icon screen.

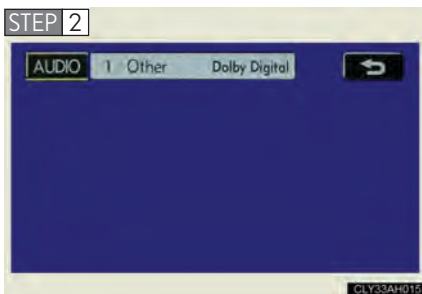

Select **AUDIO**.

Each time you press **ENT**, the next available language is selected.

↩: returns to the previous screen.

Changing the audio format (DVD audio only)

STEP 1 Press **AUDIO** or select **AUDIO** on the control icon screen.

STEP 2



Select **Audio**.

Each time you press **ENT**, the next available audio format is selected.

←: returns to the previous screen.

Changing the angle (If the angle option is available)

STEP 1 Select **Angle** on the control icon screen.

STEP 2

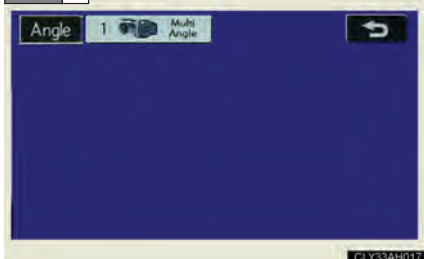

Select **Angle**.

Each time you press **ENT**, the next available angle is selected.

←: returns to the previous screen.

Initial DVD setup

■ Displaying “Setup Menu” screen

STEP 1 Select **Setup** on the control icon screen.

STEP 2

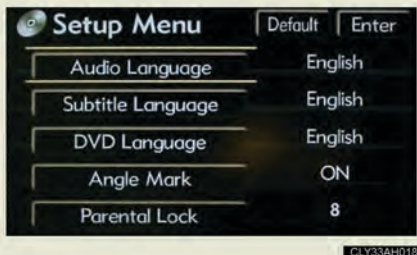

After you change the initial settings, select **Enter**.

Default: restores default settings.

■ Setting audio language

STEP 1 Select **Audio Language** on the “Setup Menu” screen.

STEP 2 Select the desired language.

If you cannot find the desired language, select **Other** and input the desired language code. (→P. 313)

↶: returns to the previous screen.

■ Setting subtitle language

STEP 1 Select **Subtitle Language** on the “Setup Menu” screen.

STEP 2 Select the desired language.

If you cannot find the desired language, select **Other** and input the desired language code. (→P. 313)

↶: returns to the previous screen.

■ Setting menu language

STEP 1 Select **DVD Language** on the “Setup Menu” screen.

STEP 2 Select the desired language.

If you cannot find the desired language, select **Other** and input the desired language code. (→P. 313)

↶: returns to the previous screen.

■ Setting angle mark ON or OFF

If the DVD has angle options, you can turn the angle mark on or off.

Select **Angle Mark** on the “Setup Menu” screen. Each time you press , the multi angle mark on the screen turns on or off alternately.

■ Parental lock

STEP 1 Select **Parental Lock** on the “Setup Menu” screen.

STEP 2



Input the 4-digit personal code and then select **Enter**.

If you enter wrong numbers, select  to delete the numbers.

Select  10 times to reset the personal code.

STEP 3 Select a parental level (1 - 8). (→P.324)

 : returns to the previous screen.

■ Entering a language code

If you select **Other** on the “Select Audio Language” screen, “Select Subtitle Language” screen or “DVD Language” screen, you can select a language by entering the 4-digit language code if that language is available.

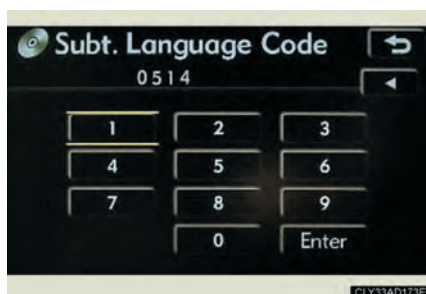

Input the 4-digit language code and then select **Enter**.

 : deletes the last input digit.

 : returns to the previous screen.

● Language codes

Code	Language	Code	Language	Code	Language
0514	English	0207	Bulgarian	0712	Galician
0618	French	0208	Bihari	0714	Guarani
0405	German	0209	Bislama	0721	Gujarati
0920	Italian	0214	Bengali	0801	Hausa
0519	Spanish	0215	Tibetan	0809	Hindi
2608	Chinese	0218	Breton	0818	Croatian
1412	Dutch	0301	Catalan	0821	Hungarian
1620	Portuguese	0315	Corsican	0825	Armenian
1922	Swedish	0319	Czech	0901	Interlingua
1821	Russian	0325	Welsh	0905	Interlingue
1115	Korean	0401	Danish	0911	Inupiak
0512	Greek	0426	Bhutani	0914	Indonesian
0101	Afar	0515	Esperanto	0919	Icelandic
0102	Abkhazian	0520	Estonian	0923	Hebrew
0106	Afrikaans	0521	Basque	1001	Japanese
0113	Amharic	0601	Persian	1009	Yiddish
0118	Arabic	0609	Finnish	1023	Javanese
0119	Assamese	0610	Fiji	1101	Georgian
0125	Aymara	0615	Faroese	1111	Kazakh
0126	Azerbaijani	0625	Frisian	1112	Greenlandic
0201	Bashkir	0701	Irish	1113	Cambodian
0205	Byelorussian	0704	Scots-Gaelic	1114	Kannada

3-4. Using the rear seat entertainment system

Code	Language	Code	Language	Code	Language
1119	Kashmiri	1415	Norwegian	1914	Shona
1121	Kurdish	1503	Occitan	1915	Somali
1125	Kirghiz	1513	(Afan) Oromo	1917	Albanian
1201	Latin	1518	Oriya	1918	Serbian
1214	Lingala	1601	Panjabi	1919	Siswati
1215	Laothian	1612	Polish	1920	Sesotho
1220	Lithuanian	1619	Pashto, Pushto	1921	Sundanese
1222	Latvian	1721	Quechua	1923	Swahili
1307	Malagasy	1813	Rhaeto- Romance	2001	Tamil
1309	Maori	1814	Kirundi	2005	Telugu
1311	Macedonian	1815	Romanian	2007	Tajik
1312	Malayalam	1823	Kinyarwanda	2008	Thai
1314	Mongolian	1901	Sanskrit	2009	Tigrinya
1315	Moldavian	1904	Sindhi	2011	Turkmen
1318	Marathi	1907	Sangho	2012	Tagalog
1319	Malay	1908	Serbo- Croatian	2014	Setswana
1320	Maltese	1909	Sinhalese	2015	Tonga
1325	Burmese	1911	Slovak	2018	Turkish
1401	Nauru	1912	Slovenian	2019	Tsonga
1405	Nepali	1913	Samoan	2020	Tatar

Code	Language	Code	Language	Code	Language
2023	Twi	2209	Vietnamese	2515	Yoruba
2111	Ukrainian	2215	Volapük	2621	Zulu
2118	Urdu	2315	Wolof		
2126	Uzbek	2408	Xhosa		

■ Error messages

If “Region Code Error” is displayed, check the region code printed on the DVD matches the player’s region code.

If a different message is displayed: →P. 320

3-4. Using the rear seat entertainment system

Playing a video CD

■ Controller



- 1 Selecting a track
- 2 Reversing a disc
- 3 Turning on the control icon screen
- 4 Stopping a disc
- 5 Fast forwarding a disc
- 6 Playing/pausing a disc
- 7 Selecting an icon
- 8 Inputting the selected icon

■ Control icon screen

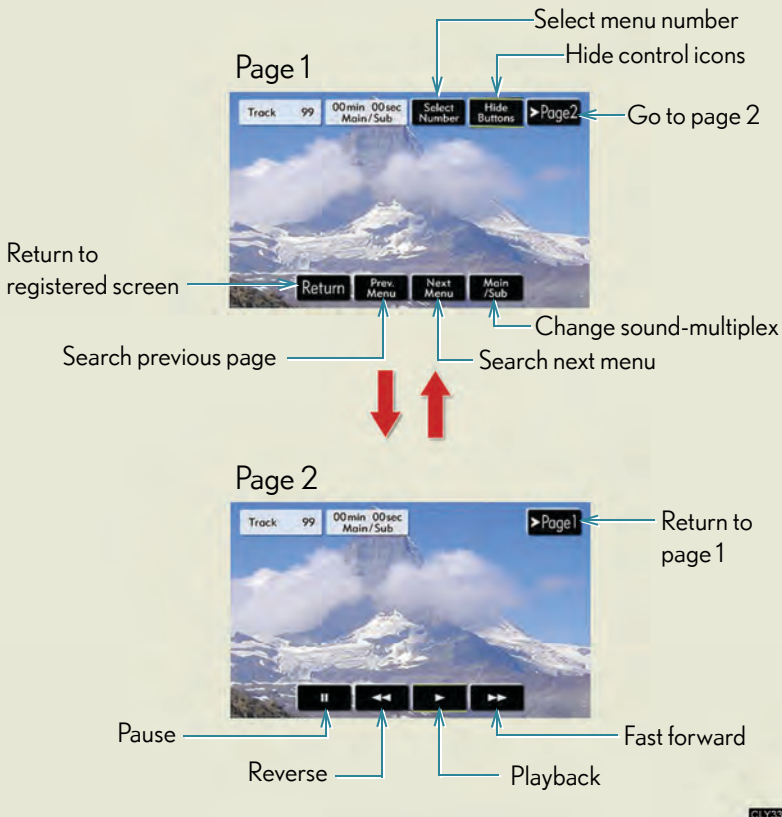

Press **OPTION** if no icons are shown while watching a video CD, and the following screen appears.



If  appears on the screen when you select an icon, the operation relevant to that control is not permitted.

Fast forwarding/reversing the video CD

Perform either of the following.

● Select  or  on the screen by pressing and holding .

● Press and hold  or  on



Slow playback

Select  and then select . Video is played slowly when you select  by pressing and holding .

Using the video CD menu

Select .

Refer to the manual that comes with the video CD for specific menu items.

Selecting a desired screen

Selecting a menu number

STEP 1 Select **Select Number** on the control icon screen.

STEP 2



Input the desired menu number on the screen and select **Enter**.

Searching manually

Select **Prev. Menu** or **Next Menu** on the screen, or press \wedge or \vee on  until the desired screen appears.

Changing the sound-multiplex mode

Select **Main/Sub** on the control icon screen. The mode cycles through each time  is selected.

“Main” → “Sub” → “Main/Sub”



3-4. Using the rear seat entertainment system

DVD player and DVD video disc information

■ Error messages







Refer to the following table and take the appropriate measures. If the problem is not rectified, take the vehicle to your Lexus dealer.

Message	Cause	Correction Procedures
No Disc	There is no disc in the DVD changer	Insert a disc
DISC X Check	<ul style="list-style-type: none">• The disc X is dirty or damaged• The disc X is inserted upside down• The disc X is not playable with the player	<ul style="list-style-type: none">• Clean the disc• Insert the disc correctly• Confirm the disc is playable with the player
DVD Error	<ul style="list-style-type: none">• There is a malfunction within the system• Operation is stopped due to a high temperature inside the player	<ul style="list-style-type: none">• Eject the disc• Eject the disc and allow the player to cool down
NO MUSIC FILE	This indicates that no playable data is included in the disc	Eject the disc

■ DVD video discs

- The DVD player conforms to PAL color TV formats.
- Region code: Some DVD video discs have a region code indicating the region in which you can use the DVD video disc. If the DVD video disc is not labeled as "ALL" or "4", you cannot use it on this DVD player. If you attempt to play an inappropriate DVD video disc on this player, "Region Code Error" appears on the screen. Even if the DVD video disc does not have a region code, you may not be able to use it.
- The rear DVD player does not support multi-channel surround sound. (only 2-channel sound is output.)

■ Symbols shown on DVD video discs

Symbol	Meaning
	Indicates PAL format.
	Indicates the number of audio tracks.
	Indicates the number of language subtitles.
	Indicates the number of angles.
	Indicates the screen display ratios available. Wide screen: 16:9 Standard: 4:3
	Indicates the disc's region code. ALL: in all countries Number: region code

■ Discs that can be used

Discs with the marks shown below can be used.

Playback may not be possible depending on recording format or disc features, or due to scratches, dirt or deterioration.



CDs with copy-protection features may not play correctly.

■ DVD player protection feature

To protect the internal components, playback is automatically stopped when a problem is detected while the DVD player is being used.

■ If discs are left inside the DVD player or in the ejected position for extended periods

Discs may be damaged and may not play properly.

■ Lens cleaners

Do not use lens cleaners. Doing so may damage the DVD player.

■ DVD video disc information

- DVD video discs

A DVD video disc is a Digital Versatile Disc that holds video. DVD video discs have adopted “MPEG2”, one of the world standards of digital compression technologies. The picture data is compressed by 1/40 on average and stored. Variable rate encoded technology in which the volume of data assigned to the picture is changed depending on the picture format has also been adopted. Audio data is stored using PCM and Dolby digital, which enables higher quality of sound. Furthermore, multi-angle and multi-language features will also help you enjoy the more advanced technology of DVD video.

- Viewer restrictions

This feature limits what can be viewed in conformity with the level of restrictions of the country. The level of restrictions varies depending on the DVD video disc. Some DVD video discs cannot be played at all, or violent scenes are skipped or replaced with other scenes.

Level 1: DVD video discs for children can be played.

Level 2-7: DVD video discs for children and G-rated movies can be played.

Level 8: All types of DVD video discs can be played.

- Multi-angle option

You can enjoy the same scene from different angles.

- Multi-language option

You can select the subtitle and audio languages.

- Region codes

The region codes are provided on DVD players and DVD discs. If the DVD video disc does not have the same region code as the DVD player, you cannot play the disc on the DVD player. (→P. 321)

- Audio

This DVD player can play linear PCM, Dolby Digital and MPEG audio format DVDs. Other decoded types cannot be played.

- Title and chapter

Video and audio programs stored in DVD video discs are divided into parts by title and chapter.

Title: The largest unit of the video and audio programs stored on DVD video discs. Usually, one movie, one album, or one audio program is assigned as a title.

Chapter: A title is comprised of one or more chapters.

■ Sound

● Dolby Digital

Manufactured under license from Dolby Laboratories.

“Dolby”, “Pro Logic”, and the double-D symbol are trademarks of Dolby Laboratories. Confidential unpublished works.

©1992-1997 Dolby Laboratories. All rights reserved.

This product incorporates copyright protection technology that is protected by method claims of certain U. S. patents and other intellectual property rights owned by Macrovision Corporation and other rights owners. Use of this copyright protection technology must be authorized by Macrovision Corporation, and is intended for home and other limited viewing uses only unless otherwise authorized by Macrovision Corporation.

Reverse engineering or disassembly is prohibited.

● DTS

“DTS” and “DTS Digital Surround” are registered trademarks of Digital Theater System, Inc.

■ MP3 and WMA files

MP3 (MPEG Audio LAYER 3) is a standard audio compression format.

Files can be compressed to approximately 1/10 of their original size by using MP3 compression.

WMA (Windows Media TMAudio) is a Microsoft audio compression format.

This format compresses audio data to a size smaller than that of the MP3 format.

There is a limit to the MP3 and WMA file standards that can be used and to the media/formats on which the files are recorded.

● MP3 file compatibility

• Compatible standards

MP3 (MPEG1 LAYER3, MPEG2 LSF LAYER3)

• Compatible sampling frequencies

MPEG1 LAYER3: 32, 44.1, 48 (kHz)

MPEG2 LSF LAYER3: 16, 22.05, 24 (kHz)

• Compatible bit rates (compatible with VBR)

MPEG1 LAYER3: 64, 80, 96, 112, 128, 160, 192, 224, 256, 320 (kbps)

MPEG2 LSF LAYER3: 64, 80, 96, 112, 128, 144, 160 (kbps)

• Compatible channel modes: stereo, joint stereo, dual channel and monaural

● WMA file compatibility

- Compatible standards
WMA Ver. 7, 8, 9
- Compatible sampling frequencies
32, 44.1, 48 (kHz)
- Compatible bit rates (only compatible with 2-channel playback)
Ver. 7, 8: CBR 48, 64, 80, 96, 128, 160, 192 (kbps)
Ver. 9: CBR 48, 64, 80, 96, 128, 160, 192, 256, 320 (kbps)

● Compatible media

Media that can be used for MP3 and WMA playback are CD-Rs and CD-RWs.

Playback in some instances may not be possible if the CD-R or CD-RW is not finalized. Playback may not be possible or the audio may jump if the disc is scratched or marked with fingerprints.

● Compatible disc formats

The following disc formats can be used.

- Disc formats: CD-ROM Mode 1 and Mode 2
CD-ROM XA Mode 2, Form 1 and Form 2
- File formats: ISO9660 Level 1, Level 2, (Romeo, Joliet)
MP3 and WMA files written in any format other than those listed above may not play correctly, and their file names and folder names may not be displayed correctly.

Items related to standards and limitations are as follows:

- Maximum directory hierarchy: 8 levels (including the root)
- Maximum length of folder names/file names: 32 characters
- Maximum number of folders: 192 (including the root)
- Maximum number of files per disc: 255

● File names

The only files that can be recognized as MP3/WMA and played are those with the extension .mp3 or .wma.

● Discs containing multi-session recordings

As the audio system is compatible with multi-sessions, it is possible to play discs that contain MP3 and WMA files. However, only the first session can be played.

● ID3 and WMA tags

ID3 tags can be added to MP3 files, making it possible to record the track title, artist name, etc.

The system is compatible with ID3 Ver. 1.0, 1.1, and Ver. 2.2*, 2.3 ID3 tags. (The number of characters is based on ID3 Ver. 1.0 and 1.1.)

* Not compatible with rear DVD player.

WMA tags can be added to WMA files, making it possible to record the track title and artist name in the same way as with ID3 tags.

● MP3 and WMA playback

When a disc containing MP3 or WMA files is inserted, all files on the disc are first checked. Once the file check is finished, the first MP3 or WMA file is played. To make the file check finish more quickly, we recommend you do not write in any files other than MP3 or WMA files or create any unnecessary folders.

Discs that contain a mixture of music data and MP3 or WMA format data cannot be played.

● Extensions

If the file extensions .mp3 and .wma are used for files other than MP3 and WMA files, they may be mistakenly recognized and played as MP3 and WMA files. This may result in large amounts of interference and damage to the speakers.

● Playback

- To play MP3 files with steady sound quality, we recommend a fixed bit rate of at least 128 kbps and a sampling frequency of 44.1 kHz.
- CD-R or CD-RW playback may not be possible in some instances, depending on the characteristics of the disc.
- There is a wide variety of freeware and other encoding software for MP3 and WMA files on the market, and depending on the status of the encoding and the file format, poor sound quality or noise at the start of playback may result. In some cases, playback may not be possible at all.
- When files other than MP3 or WMA files are recorded on a disc, it may take more time to recognize the disc and in some cases, playback may not be possible at all.
- Microsoft, Windows, and Windows Media are the registered trademarks of Microsoft Corporation in the U.S. and other countries.

 **CAUTION**

■ **DVD video precaution**

Conversational speech on some DVDs is recorded at a low volume to emphasize the impact of sound effects. If you adjust the volume assuming that the conversations represent the maximum volume level that the DVD will play, you may be startled by louder sound effects or startled when you change to a different audio source.

Loud sounds may have a significant impact on the human body or pose a driving hazard. Keep this in mind when you adjust the volume.

 NOTICE

■ Discs and adapters that cannot be used

Do not use the following types of discs, 8 cm (3 in.) disc adapters or Dual Disc. Doing so may damage the player and render the disc insert/eject function unusable.



- Discs that have a diameter that is not 12 cm (4.7 in.).
- Low-quality or deformed discs.
- Discs with a transparent or translucent recording area.
- Discs that have tape, stickers or CD-R labels attached to them, or that have the label peeled off.

NOTICE

■ Player precautions

Failure to follow the precautions below may result in damage to the discs or the player itself.

- Do not insert anything other than discs into the disc slot.
- Do not apply oil to the player.
- Store discs away from direct sunlight.
- Never try to disassemble any part of the player.

3-4. Using the rear seat entertainment system

Using the video mode

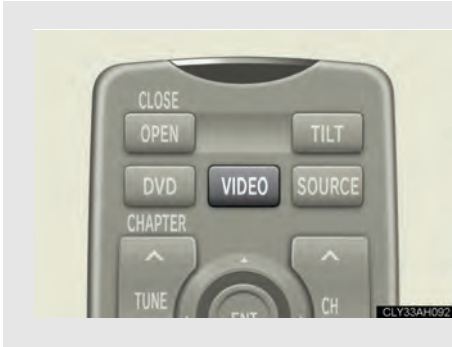

Press **VIDEO** to select the video mode.

Before switching to the video mode, connect the audio-video equipment to the A/V input adapter.

Using the adapter

► 5-seat models



Open the cover.

The A/V input adapter is composed of 3 input adapters.

Yellow: Image input adapter

White: Left channel audio input adapter

Red: Right channel audio input adapter

► 4-seat models



Changing the PAL format



Press **DISPLAY** .



If the video does not appear, turn **PAL VIDEO** on.

PAL VIDEO will be displayed when PAL format equipment is connected to the A/V input adapter.

■ A/V input adapter

The rear seat entertainment system plays videos and sound when audio-video equipment is connected to the A/V input adapter. For details, refer to the manufacturer's instructions.

■ Power outlet

The power outlet is used to connect the audio-video equipment. (→P. 403)

⚠ NOTICE

■ When the A/V input adapter is not in use

Keep the A/V input adapter cover closed.

Inserting anything other than an appropriate plug may cause electrical failure or a short circuit.

Changing other setting

Setting the display mode



Pressing **SIZE** changes the display modes sequentially as follows:

Normal → Wide 1 → Wide 2



Adjusting the screen



Press **DISPLAY**.

Select the brightness, contrast, tone or color, and make adjustments.

Press **DISPLAY** or **ENT** to input it.

Color	Red	Green
Tone	Lighter	Darker
Contrast	Weaker	Stronger
Brightness	Darker	Brighter

Automatic closing of the rear display



Press **DISPLAY**.

If **Auto Close** is on, the display will automatically close when the "ENGINE START STOP" switch is turned OFF.

The display will automatically open when the "ENGINE START STOP" switch is turned to ACCESSORY or IGNITION ON mode.

3-5. Using the hands-free system (for cellular phone)

Hands-free system (for cellular phone)

The hands-free system is a function that allows you to use your mobile phone without touching it.

This system supports Bluetooth[®] mobile phones. Bluetooth[®] is a wireless data system that allows the mobile phone to wirelessly connect to the hands-free system and make/receive calls.

The illustrations of the hands-free system screens shown here use British English. Hands-free systems that use American English may have slight differences in the text displayed compared to the illustrations shown in this Owner's Manual.

■ Telephone switch



- 1 Sending/Receiving/“Telephone” screen display (when stopped)
- 2 End call

■ Microphone



The person you are speaking to can be heard from the driver's side speaker.







To use the hands-free system, you must register your Bluetooth[®] phone in the system. (→P. 339)

Status display

You can check such indicators as signal strength and battery charge on the “Telephone” screen.



- 1 Connection status
- 2 Battery charge
- 3 Call area
- 4 Signal strength

Indicators	Conditions
Connection status	Blue: Good Yellow: Bad  : Not connected
Battery charge	 : Full  : Low  : Empty
Call area	“Rm”: Roaming area “Ho”: Home area
Signal strength	 : Good  : Bad  : Not connected

■ When using the hands-free system

- The audio system and voice guidance are muted when making a call.
- If both parties speak at the same time, it may be difficult to hear.
- If the received call volume is overly loud, an echo may be heard.
- Try to face toward the microphone as much as possible when speaking.
- In the following circumstances, it may be difficult to hear the other party.
 - When driving on unpaved roads
 - When driving at high speeds
 - If a window is open
 - If the air-conditioning is blowing directly on the microphone
 - If the air-conditioning is set to high

■ Conditions under which the system will not operate

- If using a mobile phone that does not support Bluetooth[®]
- If the mobile phone is switched off
- If you are outside service range
- If the mobile phone is not connected
- If the mobile phone's battery is low

■ Bluetooth[®] antenna

The antenna is built into the display. If the mobile phone is behind the seat or in the console box, or touching or covered by metal objects, connection status may deteriorate.

■ Battery charge/Signal status

This display may not correspond exactly with the mobile phone itself.

■ About Bluetooth®



Bluetooth is a registered trademark of Bluetooth SIG, Inc.

■ Compatible models

Compatible with HFP (Hands Free Profile) Ver. 1.0 and OPP (Object Push Profile) Ver. 1.1.

If your cellular phone does not support HFP, you cannot enter the Bluetooth® phone. If your cellular phone supports OPP alone, you cannot use the Bluetooth® phone.

■ Certification for the hands-free system

Resolução 365 – ANATEL:

“Este equipamento opera em caráter secundário, isto é, não tem direito a proteção contra interferência prejudicial, mesmo de estações do mesmo tipo, e não pode causar interferência a sistemas operando em caráter primário.”

CAUTION

■ Caution while driving

Do not use the mobile phone or connect the Bluetooth® system.



NOTICE

■ When leaving the vehicle

Do not leave your mobile phone in the vehicle. The inside of the vehicle may become hot, causing damage to the phone.

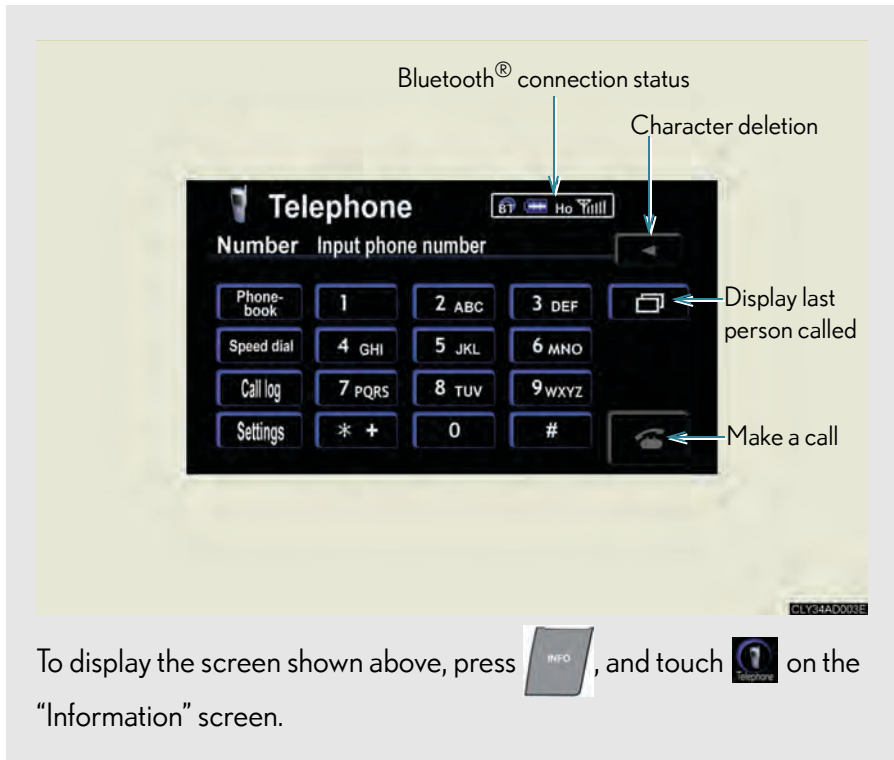
3-5. Using the hands-free system (for cellular phone) Using a Bluetooth® phone



To display the screen shown above, press , and touch  on the "Information" screen.

Registering a Bluetooth® phone

You can register up to 6 phones in the system.

STEP 1 Press  .

STEP 2 Touch  on the "Information" screen.

STEP 3 Touch  on the "Telephone" screen.

3-5. Using the hands-free system (for cellular phone)



Touch  .

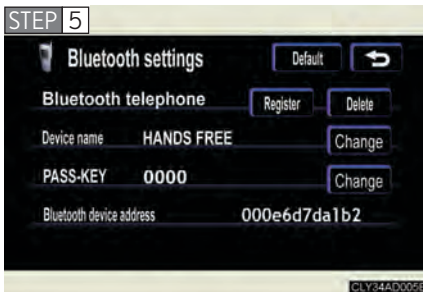

Touch  .



Input the passkey displayed on the screen into your phone.

If the message “Bluetooth* connection successful” is displayed, registration is complete.

If the message “Bluetooth* connection failed. Please check the “PASS-KEY” and the settings of the telephone” is displayed, start again from the beginning.

*: Bluetooth is a registered trademark of Bluetooth SIG, Inc.

Bluetooth® phone connection

There are two connection methods available—automatic and manual.

STEP 1 Press  .

STEP 2 Touch  on the “Information” screen.

STEP 3 Touch  on the “Telephone” screen.

STEP 4 Choose one of the following methods.



1 Automatic connection

If the “ENGINE START STOP” switch is in the ACCESSORY or IGNITION ON mode, the system will automatically connect to the Bluetooth® phone. Touching “Auto connect” will turn it on/off.

2 Manual connection

If automatic connection fails or is turned off, connection must be made manually.

If the message “Bluetooth* connection successful” is displayed, connection is complete.

*: Bluetooth is a registered trademark of Bluetooth SIG, Inc.

■ Reconnecting to the Bluetooth® phone

If the system cannot connect due to poor signal strength with the “ENGINE START STOP” switch in the ACCESSORY or IGNITION ON mode, the system will automatically attempt to reconnect.

If the phone is turned off, the system will not attempt to reconnect. In this case, connection must be made manually, or the phone must be re-selected.

Making a call

Once the Bluetooth[®] phone is registered, you can make a call using the following procedure.

■ Dialing

STEP 1 Press  .

STEP 2 Touch  on the “Information” screen.



Input the phone number.

To delete the inputted phone number, touch  .

To dial the last inputted phone number, touch  .

STEP 4 Touch  or press  on the steering wheel.

■ Dialing from the phone book

You can dial a number from the phone book data imported from your mobile phone. Up to 1000 entries may be stored in the phone book. (→P. 361)

STEP 1 Press  .

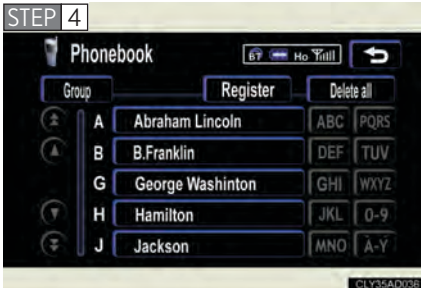

STEP 2 Touch  on the “Information” screen.

STEP 3 Touch  on the “Telephone” screen.

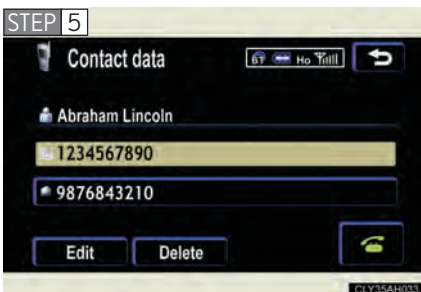

Choose the data to call from the list.



Choose the number and then touch  or press  on the steering wheel.

■ Dialing from history

You can make a call from past dialed numbers or received calls.

Up to 5 numbers are stored, with the last recent number being deleted to make room for a new number.

STEP 1 Press .

STEP 2 Touch  on the “Information” screen.

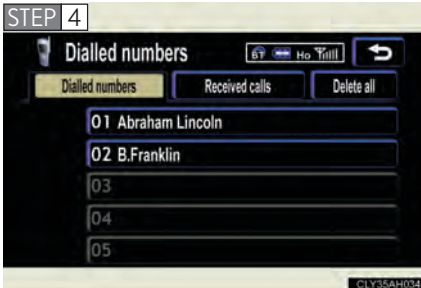

STEP 3 Touch  on the “Telephone” screen.



Choose the number to call from the list.

To choose a number from the received calls history, touch  and choose a number to call.





Touch  or press  on the steering wheel.

■ Calling using speed dial

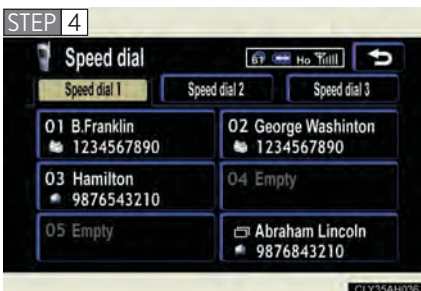
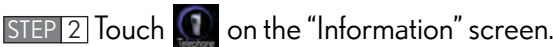
You can make a call using numbers registered from the phone book and call history. (→P. 352)



Choose the desired number to make a call.

To change the page, touch  or .

■ Calling using voice recognition

Using voice recognition, you can call by name from the “Phonebook” screen.

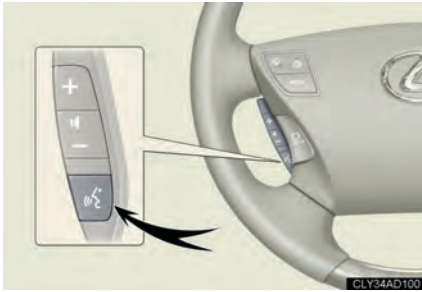

Talk switch

● Calling by name from the “Phonebook” screen

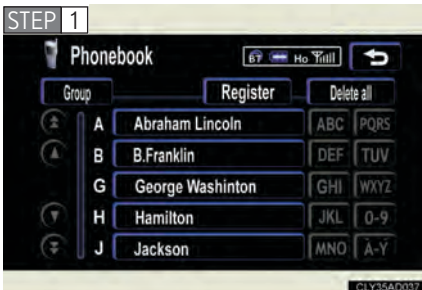



Pull  .



STEP 2 Following the system guidance, wait until a beep and then say the desired name.

If there are multiple entries for the same name, **Next** will be displayed.

To select the next candidate, touch **Next** .

STEP 3 Choose the number and then touch  or press  on the steering wheel.

■ Made/received call history list

- If you make a call to or receive a call from a number registered in the phone book, the name is displayed in the call history.
- If you make multiple calls to the same number, only the last call made is displayed in the made calls history.
-  is displayed to the left of the phone number for unanswered calls.
-  is displayed to the left of the phone number for refused calls.
- Calls where the number is unavailable, such as public telephones, are not stored in the call history.

■ When driving



- The functions “Dialing”, “Dialing from the phone book”, and “Dialing from history” are unavailable.
- If you press  on the steering wheel, the “Speed dial” screen is displayed. At this time, phone numbers will not be displayed. Choose from the names displayed to make a call.

■ International calls

You may not be able to make international calls, depending on the mobile phone in use.

■ To display the voice recognition command list





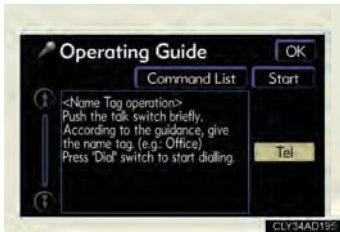

STEP 1 After pulling , touch . If the “Operating Guide” screen is displayed, touch .

STEP 2 Touch .



■ To display the voice recognition operating guide



STEP 1 After pulling , touch . If the “Command List” screen is displayed, touch .

STEP 2 Touch .

■ To cancel voice recognition

- Pull and hold .
- Press  on the steering wheel.
- Touch . (excluding command verification)



■ When using voice recognition

Use correct commands and speak clearly, otherwise the system may not correctly recognize the command. Wind or other noises may also cause the system not to recognize the desired command.

Receiving a call

When a call is received, the following screen is displayed together with a sound.





Touch  or press  on the steering wheel.

To refuse a call

Touch  or press  on the steering wheel.

To adjust the received call volume

Touch  or . You can also adjust the volume using the steering switches.

International calls

Received international calls may not be displayed correctly, depending on the mobile phone in use.

Speaking on the phone

The following screen is displayed when speaking on the phone.



■ To adjust the received call volume

Touch or . You can also adjust the volume using the steering switches.

■ To prevent the other party from hearing your voice

Touch .

■ Inputting key tone

When using phone services such as an answering service or a bank, you can store phone numbers and code numbers in the phone book.

STEP 1 Touch .



Input the number.

If repeated tone symbols* are stored in the phone book, and are displayed on the right side of the screen.

*: Repeated tone symbols are symbols or numbers displayed as p or w, that come after the phone number.
(e.g. 056133p0123w#1*)

STEP 3 Confirm the number displayed on the screen, and touch .

If you touch , this function will finish.

■ To transfer a call

Touch .



■ To hang up

Touch  or press  on the steering wheel.

■ Transferring calls

- It is not possible to transfer from hands-free to the mobile phone while driving.
- If you transfer from the mobile phone to hands-free, the hands-free screen will be displayed, and you can operate the system using the screen.
- Transfer method and operation may vary according to the mobile phone used.
- For operation of the mobile phone in use, see the phone's manual.

■ To send a tone by speed tone

Touch  and touch . Choose the desired number from the speed tone list displayed.

■ While driving



Key input is unavailable.

3-5. Using the hands-free system (for cellular phone)

Setting the hands-free system (for cellular phone)

You can speed dial, register in and edit the phone book data, and set the Bluetooth® phone.



To display the screen shown above, press , touch  on the “Information” screen, and touch  on the “Telephone” screen.

Registering/Deleting a speed dial item

■ Registering a speed dial item

You can register a number from the phone book or the call history. Up to 17 entries may be stored.

STEP 1 Press  .

STEP 2 Touch  on the “Information” screen.

STEP 3 Touch  on the “Telephone” screen.

STEP 4 Touch  on the “Settings” screen.

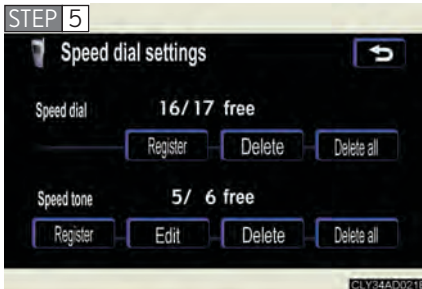

Touch  in the “Speed dial” section of the “Speed dial settings” screen.

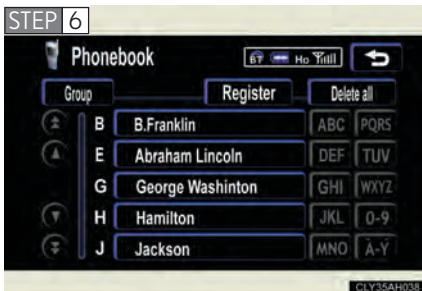

Select the data to be registered.

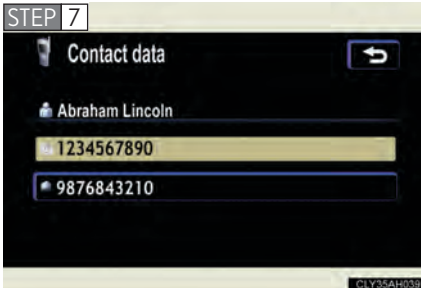

Select the number to be registered.

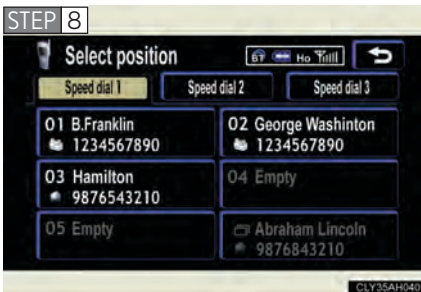

Touch the desired switch.

The last dialed number will be registered in position 6.

■ Deleting a speed dial item

STEP 1 Press  .

STEP 2 Touch  on the "Information" screen.

STEP 3 Touch  on the "Telephone" screen.



STEP 4 Touch  on the "Settings" screen.

STEP 5 Touch  in the "Speed dial" section of the "Speed dial settings" screen.

STEP 6 Select the data to be deleted, and a confirmation message will be displayed.

STEP 7 If everything is correct, touch  .

■ **To delete all speed dial items**

Follow the steps for “Deleting a speed dial item” until “STEP 5”. In the “Speed dial” section of the “Speed dial settings” screen, touch . A confirmation message will be displayed. If everything is correct, touch .

Registering/Editing/Deleting a speed tone

■ **Registering a speed tone**

You can register up to 6 items.

STEP 1 Press .

STEP 2 Touch  on the “Information” screen.

STEP 3 Touch  on the “Telephone” screen.

STEP 4 Touch  on the “Settings” screen.

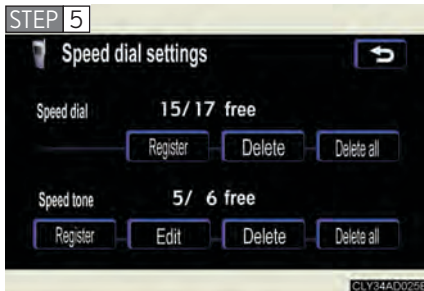

Touch  in the “Speed tone” section.



Input the desired name and touch

.

 ,  : Letter input

 : Number/Symbol input

 : Space

 : Backspace



Input the number and touch **OK**.



Touch the desired switch.

■ Editing a speed tone

STEP 1 Press  .

STEP 2 Touch  on the “Information” screen.

STEP 3 Touch **Settings** on the “Telephone” screen.

STEP 4 Touch  on the “Settings” screen.

STEP 5 Touch **Edit** in the “Speed tone” section of the “Speed dial settings” screen.



Touch the switch to be edited.

STEP 7 Input the name and touch **OK**.

STEP 8 Input the number and touch **OK**.

■ Deleting a speed tone

STEP 1 Press .

STEP 2 Touch  on the “Information” screen.

STEP 3 Touch  on the “Telephone” screen.



STEP 4 Touch  on the “Settings” screen.

STEP 5 Touch  in the “Speed tone” section of the “Speed dial settings” screen.

STEP 6 Choose the data to delete, and a confirmation message will be displayed.

STEP 7 If everything is correct, touch .

■ To delete all speed tone data

Follow the steps for “Deleting a speed tone” until “STEP 5”. In the “Speed tone” section, touch . A confirmation message will be displayed. If everything is correct, touch .

Setting the volume

STEP 1 Press  .

STEP 2 Touch  on the “Information” screen.

STEP 3 Touch  on the “Telephone” screen.

STEP 4 Touch  on the “Settings” screen.

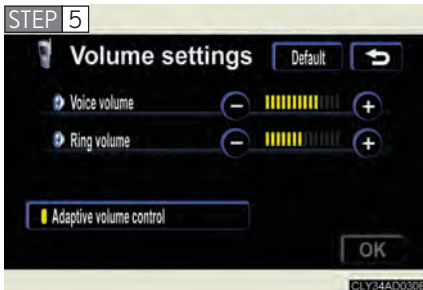

Touch  or  to lower or raise the volume.

Voice volume: changes the speaker volume

Ring volume: changes the ring volume



Adaptive volume control

When traveling at 80 km/h (50 mph) or more, the system automatically raises the volume one level.

If the vehicle speed drops to 70 km/h (43 mph), the volume will return to its original level.

You can turn this function on/off by touching  .

To return to the default volume settings

Touch  , and then  .

Changing the screen settings

The following settings can be changed.

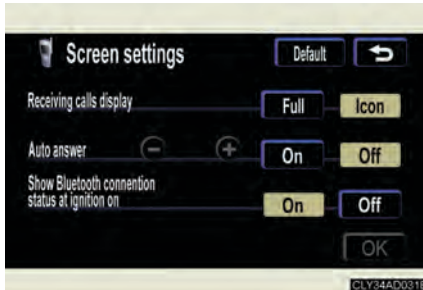

- “Receiving calls display”
The incoming call screen settings can be changed.

- “Auto answer”
When a call is received, the system automatically switches to the talking screen after the set period of time, meaning you can speak without pressing anything.

- “Show Bluetooth* connection status at ignition on”

You can set the system to show the status confirmation display when connecting.

*: Bluetooth is a registered trademark of Bluetooth SIG, Inc.

■ “Receiving calls display” settings

STEP 1 Press  .

STEP 2 Touch  on the “Information” screen.

STEP 3 Touch  on the “Telephone” screen.

STEP 4 Touch  on the “Settings” screen.

STEP 5 Select the desired switch.

 **Full** : The hands-free screen is displayed when a call is received, and you can operate the system from that screen.

 **Icon** : A message is displayed at the top of the screen, and you can only operate the system with the steering switches.

■ “Auto answer” settings

STEP 1 Press  .

STEP 2 Touch  on the “Information” screen.

STEP 3 Touch  on the “Telephone” screen.

STEP 4 Touch  on the “Settings” screen.

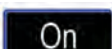
STEP 5 Touch  **On** in the “Auto answer” section of the “Screen settings” screen.

STEP 6 Set the wait time using  and  . (1 - 60 seconds)

■ “Show Bluetooth* connection status at ignition on” settings

STEP 1 Press  .

STEP 2 Touch  on the “Information” screen.

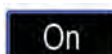
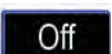

STEP 3 Touch  on the “Telephone” screen.

STEP 4 Touch  on the “Settings” screen.

STEP 5 Touch  /  in the “Show Bluetooth* connection status at ignition on” section of the “Screen settings” screen.

*: Bluetooth is a registered trademark of Bluetooth SIG. Inc.

■ To set the screen settings to default

Touch  , and then  .

Phone book settings

Up to 1000 names, 2 items per name, can be registered.

■ Transferring mobile phone data

STEP 1 Press .

STEP 2 Touch  on the “Information” screen.

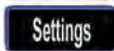
STEP 3 Touch  on the “Telephone” screen.

STEP 4 Touch  on the “Settings” screen.

STEP 5 Touch .

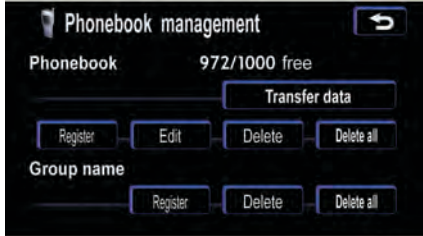

STEP 6

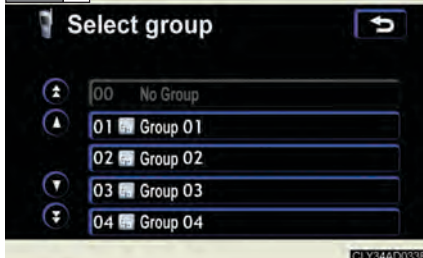

Select the group to transfer to.

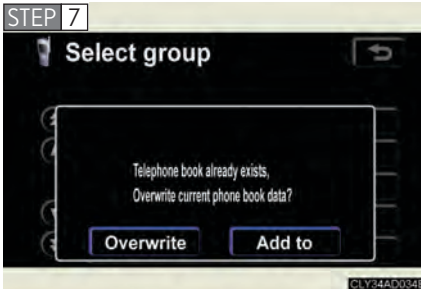

To overwrite data, touch **Overwrite**.

To add to existing data, touch **Add to**.



Transfer will begin. If you wish to cancel the transfer before it is finished, touch **Cancel**.

Transfer is complete when “Transfer completed” is displayed. If “Transfer failed” is displayed, restart the process from the beginning.

■ Registering by input

STEP 1 Press **INFO**.

STEP 2 Touch **Telephone** on the “Information” screen.

STEP 3 Touch **Settings** on the “Telephone” screen.

STEP 4 Touch **Phonebook** on the “Settings” screen.

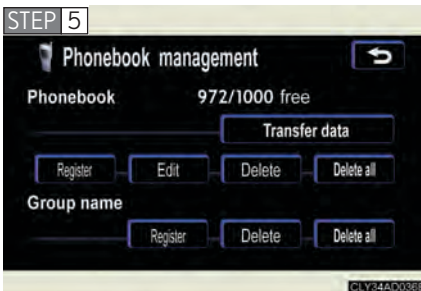

Touch the **Register** in the “Phonebook” section.

STEP 6 Choose the switch to register.

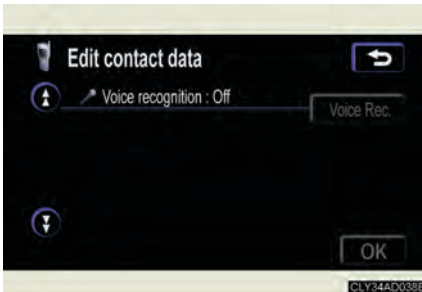
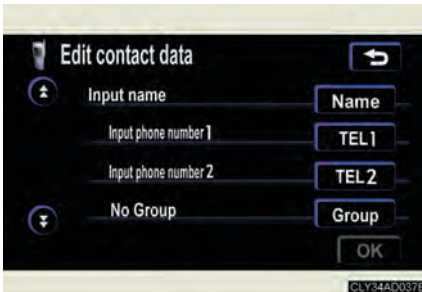

Name : Input the name on the “Name” screen.

TEL 1 and **TEL 2** : Input the number(s) on the “Ring” screen. When you touch **OK**, the “Select Icon” screen will appear.

Choose the desired icon.

- **Mobile phone1**
- **Mobile phone2**
- **Home**
- **Work**
- **Other**

Group : Select the desired group from the “Select Group” screen. (No Group, 01 - 09)

Voice Rec. : Select the desired phone number and touch **REC** to record a voice tag.

To play the voice tag, touch **PLAY**. To delete the voice tag, touch **Delete**.

STEP 7 Once input is complete, touch **OK**.

■ Adding call history data to a registered entry

STEP 1 Press  .

STEP 2 Touch  on the “Information” screen.

STEP 3 Touch  on the “Telephone” screen.

STEP 4 Choose the desired number from the list.

To choose from the received call history, touch  and select the desired number.

STEP 5 Touch  .



The screenshot shows a 'Log data' screen with the following details: a phone icon, 'Log data' title, '67 Ho Trill' and a back arrow at the top right; a call duration of '00 / 00 00 : 00'; the name 'B. Franklin'; and the number '1234567890'. At the bottom, there are three buttons: 'Register', 'Add to', and 'Delete', along with a telephone handset icon.

STEP 6 Choose the phone book entry to be added to.

STEP 7 Check the data to be added, and touch  .

■ Editing phone book data

STEP 1 Press  .

STEP 2 Touch  on the “Information” screen.

STEP 3 Touch  on the “Telephone” screen.

STEP 4 Touch  on the “Settings” screen.

STEP 5 Touch  in the “Phonebook” section of the “Phonebook management” screen.

STEP 6 Choose the data to edit.

STEP 7 Choose the switch to edit.

STEP 8 After editing, touch  .

■ Deleting phone book data

STEP 1 Press  .

STEP 2 Touch  on the “Information” screen.

STEP 3 Touch  on the “Telephone” screen.



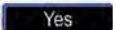

STEP 4 Touch  on the “Settings” screen.

STEP 5 Touch  in the “Phonebook” section of the “Phonebook management” screen.

STEP 6 Select the data to delete.

STEP 7 A confirmation message will be displayed. If everything is correct, touch  .

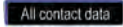
■ To delete all data

Follow the steps for “Deleting phone book data” until “STEP 5”. In the “Phonebook” section of the “Phonebook management” screen, touch . To delete all data within a group, touch , and select the group to delete. To delete all contact data, touch . Check that everything is correct, and touch .

■ Registering/Editing/Deleting from the phone book

You can register data in the phone book, edit registered data, and delete items.



STEP 1 Press .

STEP 2 Touch  on the “Information” screen.

STEP 3 Touch  on the “Telephone” screen.

STEP 4 To register data, touch  on the “Phonebook” screen.

To delete all data, touch .

To delete or edit specific data, select the data to delete/edit, and touch  to delete, or  to edit.

■ The phone book

The method for transferring phone book data from the phone to the system varies with phone model. See the phone’s manual.

Changing the phone book group name settings

■ Registering a group name

STEP 1 Press .

STEP 2 Touch  on the “Information” screen.

STEP 3 Touch  on the “Telephone” screen.

STEP 4 Touch  on the “Settings” screen.

STEP 5 Touch  in the “Group name” section of the “Phonebook management” screen.

STEP 6 Select the group to register (“01” - “19”).



Select the switch to be edited.

Icon : The below screen will be displayed. Select the desired icon.

Name : Input the name on the “Name” screen.

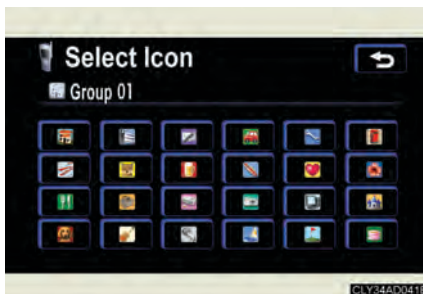



STEP 8 Once editing is complete, touch .

■ Deleting a group name

STEP 1 Press  .

STEP 2 Touch  on the “Information” screen.

STEP 3 Touch  on the “Telephone” screen.

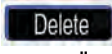

STEP 4 Touch  on the “Settings” screen.

STEP 5 Touch  in the “Group name” section of the “Phonebook management” screen.

STEP 6 Select the group name to delete, and a confirmation message will be displayed.

STEP 7 If everything is correct, touch  .

■ To delete all data

Follow the steps for “Deleting phone book data” until “STEP 5”. In the “Phonebook” section of the “Phonebook management” screen, touch  . A confirmation message will be displayed. If everything is correct, touch  .

Deleting the history

STEP 1 Press  .

STEP 2 Touch  on the “Information” screen.

STEP 3 Touch  on the “Telephone” screen.

STEP 4 Select the data to delete from the list.



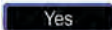

To delete data from the received calls history, touch , and select the data to delete.

STEP 5 Touch  .



STEP 6 Check that everything is correct, and touch  .

To delete all data

Follow the steps for “Deleting a group name” until “STEP 4”. Touch  on the “Dialled numbers” screen. To delete all received call history data, touch , and touch  . Check that everything is correct, and touch  .

Changing the security settings

You can disable certain hands-free system functions. Use the security settings when you do not wish other people to see the registered data, for example when having the vehicle valet parked at a hotel.

To enable or disable security, the security code (4 digits) is required. The default code is "0000". Be sure to change the security code before use.

■ Changing the security code

STEP 1 Press  .

STEP 2 Touch  on the "Information" screen.

STEP 3 Touch  on the "Telephone" screen.

STEP 4 Touch  on the "Settings" screen.

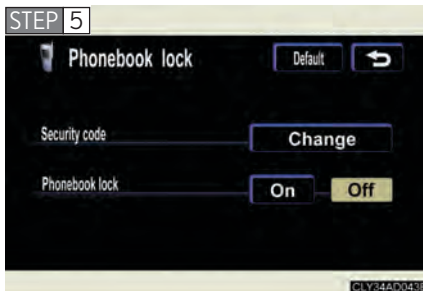

Touch  in the "Security code" section.

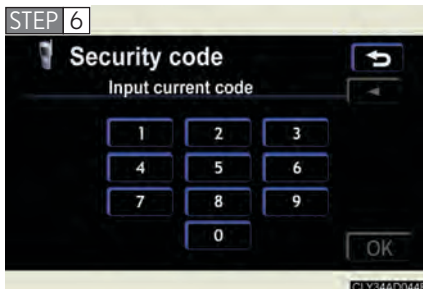

Input the current security code, and touch  .

STEP 7 Input the new security code, and touch **OK**. A confirmation message will appear.

STEP 8 If everything is correct, touch **Yes**.

■ Enabling security

STEP 1 Press .

STEP 2 Touch  on the “Information” screen.

STEP 3 Touch **Settings** on the “Telephone” screen.

STEP 4 Touch  on the “Settings” screen.

STEP 5 Touch **On** in the “Phonebook lock” section of the “Phonebook lock” screen.

STEP 6 Input the security code, and touch **OK**.

■ Setting the security code to default

STEP 1 Press .

STEP 2 Touch  on the “Information” screen.

STEP 3 Touch **Settings** on the “Telephone” screen.

STEP 4 Touch  on the “Settings” screen.

STEP 5 Touch **Default** on the “Phonebook lock” screen.

STEP 6 Input the security code on the “Security code” screen, and touch **OK**. A confirmation message will appear.

STEP 7 If everything is correct, touch **Yes**.

■ If “Phonebook lock” is set

If the security code is input and the “Phonebook lock” is set, the following functions are locked.

- Display of the phone book screen and transferring, registering, editing and deleting the phone book data.
- Display of the speed dial screen, registering, deleting the speed dial and speed dialing.
- Display of the other party's name for calls being received or made.
- Display of the dialed numbers screen and received call screen, deleting the dialed numbers and received numbers.
- Display of the phone information screen.
- Changing the security code.

The speed dial screen is not displayed while driving.

■ When changing the security code

- Be sure to choose a number difficult for strangers to guess.
- Do not forget the security code. Even your Lexus dealer will be unable to disable the security. If you do forget the code, initialize all personal data. (→P. 201)

Setting a Bluetooth® phone

■ Selecting a Bluetooth® phone

If multiple Bluetooth® phones are registered, follow the procedure below to select the Bluetooth® phone to be used. You may only use one phone at a time.

STEP 1 Press  .

STEP 2 Touch  on the “Information” screen.

STEP 3 Touch  on the “Telephone” screen.



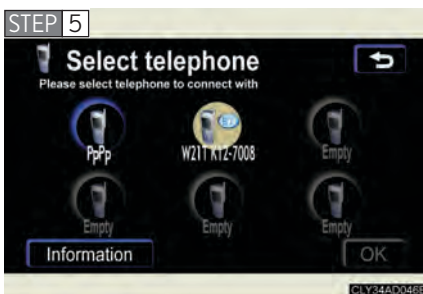

Touch  .



Select the phone to be used, and touch  .

If no phones are registered, “Empty” will be displayed.

If “Bluetooth* connection successful” is displayed, registration was successful.

If another Bluetooth® phone is already connected, a confirmation message is displayed. Touch  or  .

*: Bluetooth is a registered trademark of Bluetooth SIG, Inc.

■ Displaying Bluetooth® information

You can check the device address and device name.

STEP 1 Press  .

STEP 2 Touch  on the “Information” screen.

STEP 3 Touch  on the “Telephone” screen.

STEP 4 Touch  on the “Settings” screen.

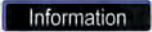
STEP 5 On the “Select telephone” screen, select the desired phone and touch  .

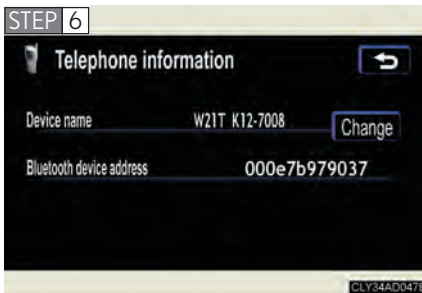

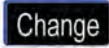
To change the device name, touch  in the “Device name” section, and input the name on the “Name” screen (max. 20 characters).

■ To change the Bluetooth® settings

You can change the device name and passkey.

STEP 1 Press  .

STEP 2 Touch  on the “Information” screen.

STEP 3 Touch  on the “Telephone” screen.

STEP 4 Touch  on the “Settings” screen.



To change the device name, touch **Change** in the “Device name” section, and input the name on the “Name” screen (max. 20 characters).

To change the passkey, touch **Change** in the “PASS-KEY” section, and input 4 - 8 digits on the “PASS-KEY” screen.

■ Setting the Bluetooth® settings to default

STEP 1 Press  .

STEP 2 Touch  on the “Information” screen.

STEP 3 Touch **Settings** on the “Telephone” screen.

STEP 4 Touch  on the “Settings” screen.

STEP 5 Touch **Default** on the “Bluetooth* settings” screen, and a confirmation message is displayed.

STEP 6 If everything is correct, touch **Yes** .

*: Bluetooth is a registered trademark of Bluetooth SIG. Inc.

■ To delete the Bluetooth® settings

STEP 1 Press  .

STEP 2 Touch  on the “Information” screen.

STEP 3 Touch  on the “Telephone” screen.

STEP 4 Touch  on the “Settings” screen.

STEP 5 Touch  in the “Bluetooth* telephone” section of the “Bluetooth* settings” screen.

STEP 6 On the “Delete telephone” screen, select the phone to delete.
To check the device address, touch  .

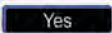
STEP 7 If you touch  , a confirmation message is displayed. If everything is correct, touch  .

*: Bluetooth is a registered trademark of Bluetooth SIG. Inc.

3-6. Using the interior lights

Interior lights list

Your Lexus is equipped with the illuminated entry system to assist in entering the vehicle. Owing to the function of the system, the lights shown in the following illustration automatically turn on/off according to the presence of the electronic key, whether the doors are locked/unlocked, whether the doors are opened/closed, and the “ENGINE START STOP” switch mode.

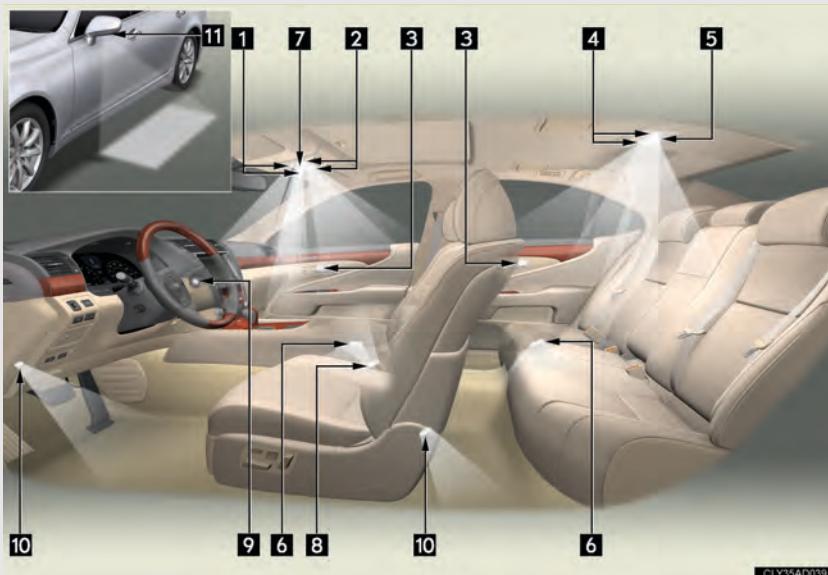

- 1 Front personal lights (→P. 379)
- 2 Front interior lights (→P. 379)
- 3 Inside door handle lighting
- 4 Rear personal lights (→ P. 379)
- 5 Rear interior light
- 6 Door courtesy lighting
- 7 Shift lever lighting (when the “ENGINE START STOP” switch is in ACCESSORY or IGNITION ON mode)

- 8 Seat belt buckle lighting
- 9 "ENGINE START STOP" switch lighting
- 10 Footwell lighting
- 11 Outer foot lights

Interior lights



- 1** OFF
- 2** Door position on/off
- 3** ON

Personal lights

► Front



- 1** On/off

► Rear (without rear seat entertainment system)



- 1** On/off

► Rear (with rear seat entertainment system)



1 On/off

■ To prevent the battery from being discharged

If the interior lights remain on when the door is not fully closed and the interior light switch (door position on/off) is on, the lights will go off automatically after 20 minutes.

■ Customization that can be configured at Lexus dealer

Settings (e.g. the time elapsed before lights turn off) can be changed.
(Customizable features →P. 556)

3-7. Using the storage features

List of storage features

► 5-seat models

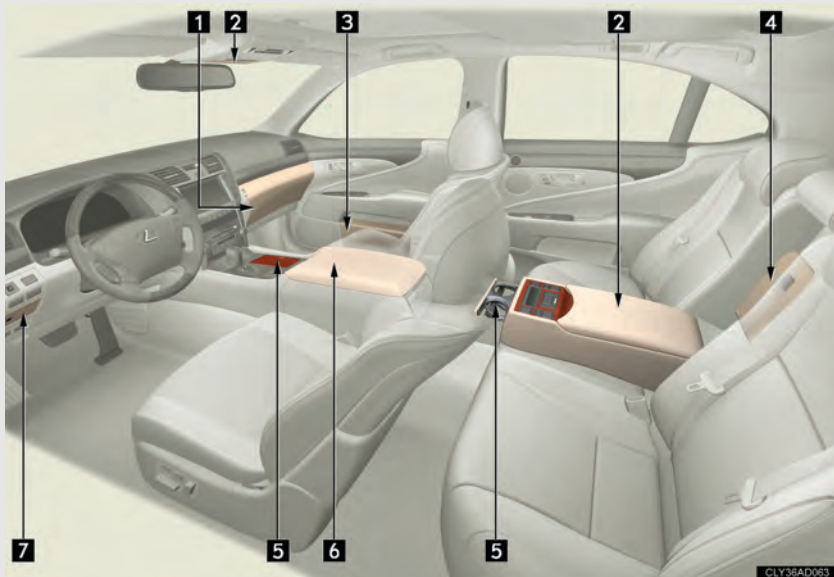

- 1 Glove box
- 2 Auxiliary boxes
- 3 Door pockets
- 4 Cool box (if equipped)
- 5 Cup holders
- 6 Console box
- 7 Coin holder

► 4-seat models

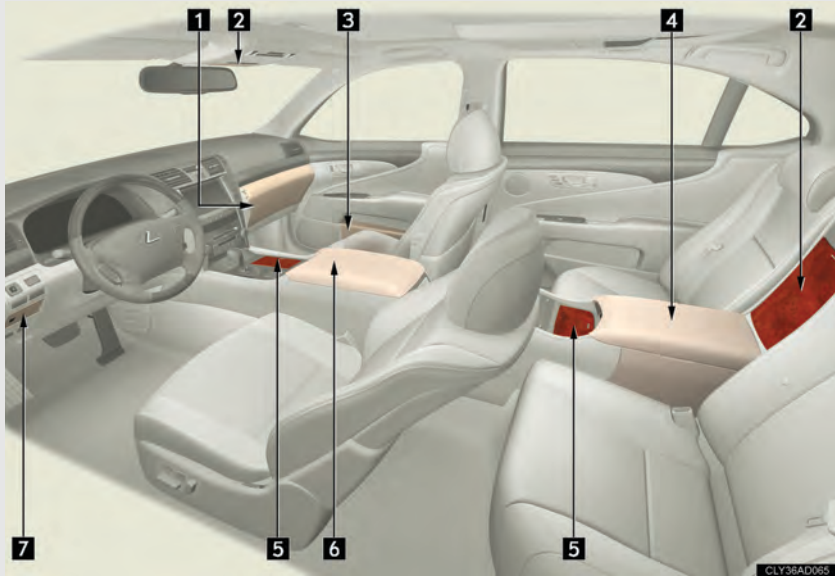

- 1 Glove box
- 2 Auxiliary boxes
- 3 Door pockets
- 4 Cool box
- 5 Cup holders
- 6 Console box
- 7 Coin holder

Glove box

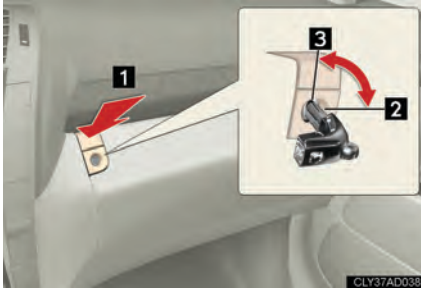

- 1 Open (push button)
- 2 Lock with the mechanical key
- 3 Unlock with the mechanical key

Trunk opener main switch

The trunk opener main switch is located in the glove box. (→P. 55)

⚠ CAUTION

■ Caution while driving

Keep the glove box closed.
Injuries may result in the event of an accident or sudden braking.

Coin holder

Press in the button.

⚠ CAUTION**■ Caution while driving**

Keep the coin holder closed.

Injuries may result in the event of an accident or sudden braking.

Door pockets (front)



The front door pockets can be opened and closed.

CAUTION

Caution while driving

Keep the door pockets closed.
Injuries may result in the event of an accident or sudden braking.

Cup holders

▶ Front

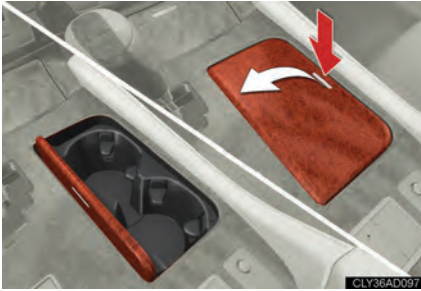

Press down and release the right side of the cup holder lid.

▶ Rear (5-seat models)



Press in and release the cup holder.

▶ Rear (4-seat models)



Press in and release the button.

⚠ CAUTION**■ Items unsuitable for the cup holder**

Do not place anything other than cups or aluminum cans in the cup holders. Other items may be thrown out of the holders in the event of an accident or sudden braking and cause injury. If possible, cover hot drinks to prevent burns.

■ When not in use

Keep the cup holders closed. Injuries may result in the event of an accident or sudden braking.

Console box

1 Slide the armrest while pushing the knob.

2 Lift the armrest.

■ Tray in the console box

The tray can be raised backward.

■ Opening and closing assist function

When the console box is opened or closed partway, this function will apply force in the appropriate direction, helping open or close the console box.

 **CAUTION**

■ **Caution while driving**

Keep the console box closed.
Injuries may result in the event of an accident or sudden braking.

 **NOTICE**

■ **Tray**

Do not insert items exceeding the height of the tray. Doing so may prevent opening and closing of the lid.

Cool box (if equipped)

This keeps drinks cool whenever the rear air conditioning system is on. Use for holding canned drinks.

► 5-seat models

STEP 1



Pull down the armrest.

STEP 2

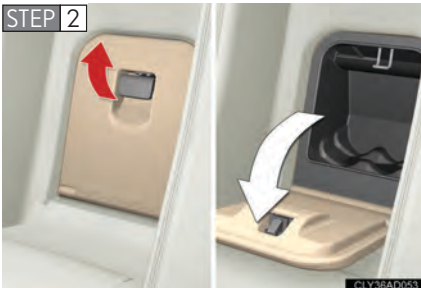

Pull the lever.

STEP 3



Open the cool air intake lid.

► 4-seat models

STEP 1

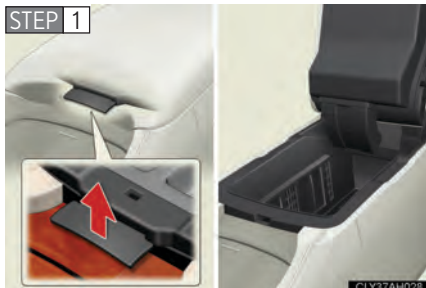

Pull up the lever to release the lock and lift the lid.

STEP 2

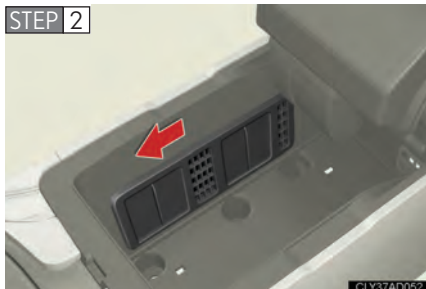

Open the cool air intake lid.

■ Operating conditions (cool box)

▶ 5-seat models

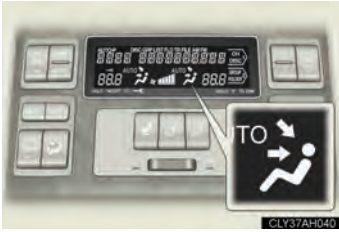

- The rear air conditioning system is on.
-  is displayed on the rear control panel.

▶ 4-seat models

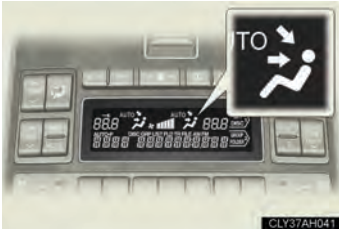

■ Using a cool box as a storage compartment

▶ 5-seat models



Close the cool air intake lid to turn off the cool box system.

▶ 4-seat models



Close the cool air intake lid to turn off the cool box system.

■ Items unsuitable for the cool box

- Drinks in unsealed containers
- Fragile items, perishables or anything with strong odor

⚠ CAUTION

■ Caution while driving

Always keep the cool box closed to reduce the chance of injury in case of an accident or sudden stop.

Auxiliary boxes

► Overhead



Press in the button.

This box is useful for temporarily storing sunglasses and similar small items.

► Rear seat (5-seat models)



Pull down the armrest.

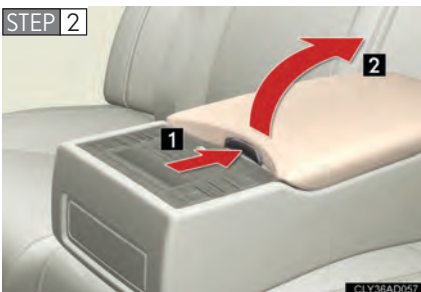

1 Press the button to release the lock.

2 Lift the lid.

► Rear console box (4-seat models)



Press in the lid.

This box is useful for storing DVD discs and headphones.

⚠ CAUTION

■ **Items that should not be left in the box (overhead)**

Do not leave glasses or lighters in the box.

If the interior of the vehicle becomes hot, lighters may explode and glasses may warp or crack.

■ **Caution while driving**

Do not leave the auxiliary box open while driving.

Items may fall out and cause death or serious injury in case of an accident or sudden stop.

Sun visors

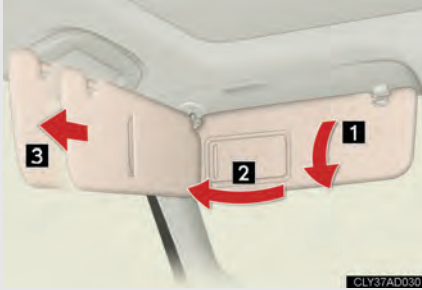

- 1** Forward position:
Flip down.
- 2** Side position:
Flip down, unhook, and swing to the side.
- 3** Side extender:
Place in side position, then slide backward.

3-8. Other interior features

Vanity mirror

► Front



Slide the cover.

The light turns on when the cover is opened.

► Rear

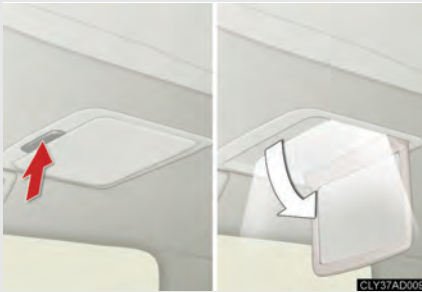

Press the button to open.

The vanity light turns on.

NOTICE

■ When not in use

Keep the rear vanity mirror closed.

■ To prevent the battery from being discharged

Do not leave the vanity lights on for extended periods while the engine is stopped.

3-8. Other interior features

Clock

The clock is displayed when the “ENGINE START STOP” switch is in ACCESSORY or IGNITION ON mode. Perform the following steps to adjust the clock.

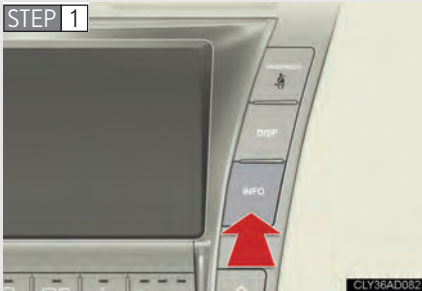

Press “INFO”.

STEP 2 Touch **Adjust clock** .

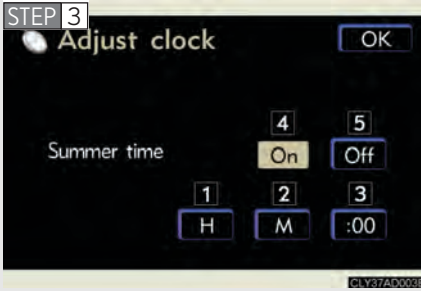

- 1 Adjusts the hour.
- 2 Adjusts the minutes.
- 3 Rounds to the nearest hour.*
- 4 Turn summer time on.
- 5 Turn summer time off.

After setting, touch **OK** .

*:e.g. 1:00 to 1:29 → 1:00

1.30 to 1.59 → 2:00

■ **When the battery is disconnected**

The time display will automatically be set to 1:00.

3-8. Other interior features

Outside temperature display

The displayed temperature ranges from -40°C (-40°F) up to 50°C (122°F) when the “ENGINE START STOP” switch is in IGNITION ON mode.



■ When “--” or “E” is displayed

The system may be malfunctioning. Take your vehicle to your Lexus dealer.

3-8. Other interior features

Ashtrays

► Front



Push the front part of the lid to open. Push the lid again to close.

To remove, pull the ashtray upwards

► Rear

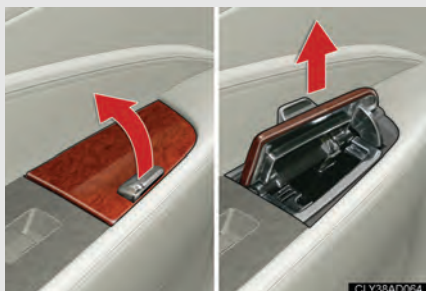

Open the ashtray lid.

To remove, pull the ashtray upwards

CAUTION

■ When not in use

Keep the ashtray closed.

Injuries may result in the event of an accident or sudden braking.

■ To prevent fire

● Fully extinguish matches and cigarettes before putting them in the ashtray, then make sure the ashtray is fully closed.

● Do not place paper or any other type of flammable object in the ashtray.

3-8. Other interior features

Cigarette lighter

► Front



Push the front part of the lid to open, and push the cigarette lighter down.

The cigarette lighter will pop up when it is ready for use.

► Rear (5-seat models)

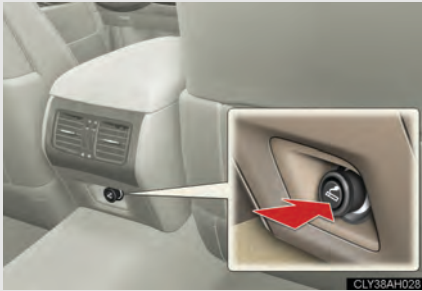

Push the cigarette lighter.

The cigarette lighter will pop out when it is ready for use.

► Rear (if equipped)



Open the auxiliary box and push the cigarette lighter.

The cigarette lighter will pop out when it is ready for use.

■ The cigarette lighter can be used when

The "ENGINE START STOP" switch is in ACCESSORY or IGNITION ON mode.



CAUTION

■ To avoid burns or fires

- Do not touch the metal parts of the cigarette lighter.
- Do not hold the cigarette lighter down. It could overheat and cause a fire.
- Do not insert anything other than the cigarette lighter into the outlet.

■ When not in use

Keep the ashtray closed.

Injuries may result in the event of an accident or sudden braking.

3-8. Other interior features

Power outlet

The power outlet can be used for 12 V accessories that run on less than 10 A.

► Front



► Rear (if equipped)



■ The power outlet can be used when

The "ENGINE START STOP" switch is in ACCESSORY or IGNITION ON mode.

 NOTICE

■ **To avoid damaging the power outlet**

Close the power outlet lid when the power outlet is not in use.
Foreign objects or liquids that enter the power outlet may cause a short circuit.

■ **To prevent the fuse from being blown**

Do not use an accessory that uses more than 12 V 10 A.

■ **To prevent the battery from being discharged**

Do not use the power outlet longer than necessary when the engine is not running.

Heated steering wheel (if equipped)

The heated steering wheel can be used to heat the leather portion of the steering wheel.



On/off

The indicator light comes on when the heater is operating.

■ Operating condition

The “ENGINE START STOP” switch is in IGNITION ON mode.

■ Timer

The heated steering wheel will automatically turn off after about 30 minutes.

■ If the indicator light flashes

Press the button to turn the heated steering wheel off and then press the button again. If the indicator light still flashes, a malfunction may be occurring. Turn the heated steering wheel off and have the vehicle inspected by your Lexus dealer.

 CAUTION

■ Burns

Only appropriately qualified and capable non-impaired persons should operate the vehicle. However, care should be taken to prevent injury if anyone in the following categories comes into contact with the steering wheel when the heated steering wheel is on.

- Babies, small children, the elderly, the sick and the disabled
- Persons with sensitive skin
- Persons who are fatigued
- Persons who have taken alcohol or drugs that induce sleep (sleeping drugs, cold remedies, etc.)

 NOTICE

■ To prevent the battery from being discharged

Turn the switches off when the engine is not running.

3-8. Other interior features

Climate control seats

The temperature of the seats can be adjusted individually.

■ Front climate control seats

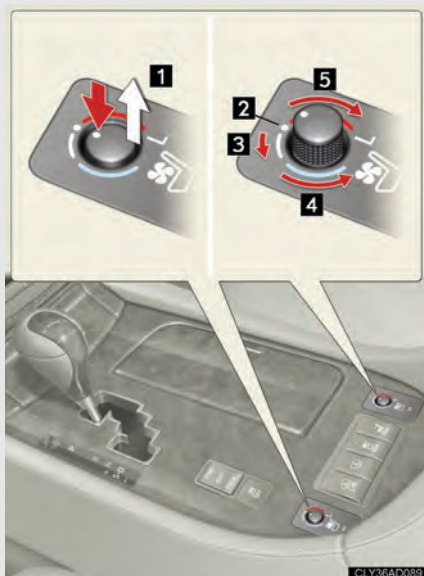

- 1 Press the knob to release it, and turn the knob to the desired temperature setting.
- 2 Off
Press the knob to lock it when not in use.
- 3 Ventilation
- 4 Cool air
- 5 Warm air

■ Rear climate control seats

▶ 5-seat models

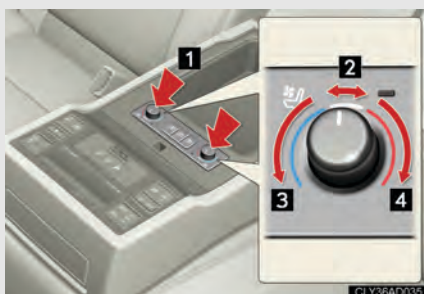

- 1 Press the knob to turn the system on, and turn the knob to the desired temperature setting.
Press the knob again to turn the system off.
- 2 Ventilation
- 3 Cool air
- 4 Warm air

▶ 4-seat models

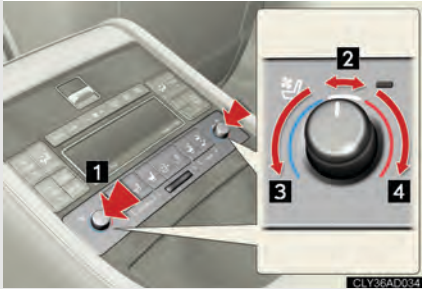

The rear climate control seats can also be turned on and off from the front seats.

■ Operating condition

The “ENGINE START STOP” switch is in IGNITION ON mode.

■ Replacing the air filters

Filters are installed in the climate control seats. For replacement of the filters, contact your Lexus dealer.

 **CAUTION****■ Burns/excessive cooling**

- Use caution when seating the following persons in a seat to avoid the possibility of burns or excessive cooling.
 - Babies, small children, elderly persons, sick persons and persons with a physical disability
 - Persons who have sensitive skin
 - Persons who are fatigued
 - Persons who have taken alcohol or drugs which induce sleep, such as sleeping drugs and cold remedies
- Do not cover the seat with anything when using the climate control seat. Using the climate control seat or seat heater with a blanket or cushion may increase or decrease the temperature of the seat, resulting in overheating or overcooling.
- Do not use the climate control seat more than necessary. Doing so may cool the occupants excessively or may cause minor burns or overheating.

 **NOTICE****■ To prevent damage to the climate control seat**

Do not put heavy objects that have an uneven surface on the seat and do not stick sharp objects, such as needles and nails, into the seat.

■ To prevent the battery from being discharged

Do not leave the system on longer than necessary when the engine is off.

3-8. Other interior features

Armrest (5-seat models)



Pull the armrest down for use.

NOTICE

- **To prevent damage to the armrest**
Do not place too much strain on the armrest.

3-8. Other interior features

Rear seat relaxation system (4-seat models)

Pneumatic chambers and vibration units built into the right-hand rear seat provide the occupant with 3 speeds and intensities of pressure and 7 speeds of vibration.



- 1 "ON/OFF" - turns the system on and off.
If no buttons are selected for about 3 minutes, the system will automatically turn off.
- 2 "SHIATSU" - starts the "SHIATSU" program.
- 3 "STRETCH" - starts the "STRETCH" program.
- 4 "SHOULDER" - starts manual operation for the upper back.
- 5 "BACK" - starts manual operation for the lower back.
- 6 "INTENSITY" - adjusts the intensity of air pressure.
- 7 "SPEED" - adjusts the speed of air unit.
- 8 "VIB." - turn the vibration on and off.

9 "VIB. SPEED" - adjusts the vibration speed.

The vibration function can be operated along with the "SHIATSU", "STRETCH", "BACK" or "SHOULDER" function. If these functions are operated together, pressing either the VIB. button or the previously selected button ("SHIATSU", "STRETCH", "BACK" or "SHOULDER") stops the corresponding operation.

■ Programmed operations

- "SHIATSU"
— Partial pressure for the whole back.
- "STRETCH"
— Stretches and relaxation of the whole back.

■ Timer function

Each operation will automatically stop about 15 minutes after it starts.

■ Operating condition

The "ENGINE START STOP" switch is in IGNITION ON mode.

CAUTION

■ Using the rear seat relaxation system

- Those who are pregnant, have recently give birth, or suffer from ailments requiring rest (heart disease etc.) should consult a doctor before use.
- Do not allow children to use the relaxation function.
- Do not use immediately after a meal or for an extended period of time.
- If you feel sick while using the relaxation function, immediately discontinue use.

3-8. Other interior features

Retractable table (if equipped)

STEP 1

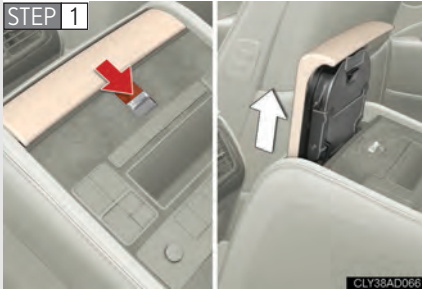

Slide the lever to raise the table.

STEP 2

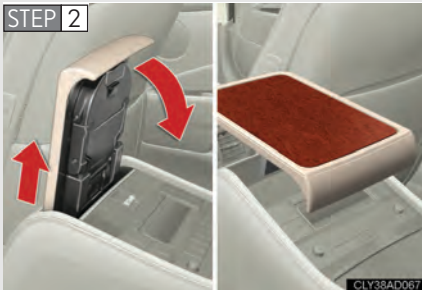

Pull the table up and pull down the table.



The position of the table can be changed. Before using the table, make sure that the table is securely locked.

When turning the table, the front seats will stop if they are going to contact the table.



When returning the table, pull it up while pulling the lock release lever.

 **CAUTION**

■ **When not in use**

To avoid injury, return the table.

■ **Caution while driving**

Keep the table stowed properly in its place. In the event of an accident, contact with the table may result in death or serious injury.

■ **When using the table**

Observe the following precautions. Failure to do so may result in death or serious injury.

- Make sure the table is securely locked.
- Do not lean on the table.
- Do not put anything heavier than 10 kg (22 lb.) on the table.

 **NOTICE**

■ **To prevent damage to the table**

Do not place too much strain on the table.

Rear sunshade

The rear sunshade can be raised and lowered by operating any of the buttons shown below.

► From front seat

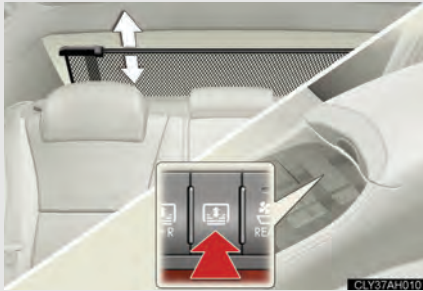

Extend/retract

► From rear seat (5-seat models)

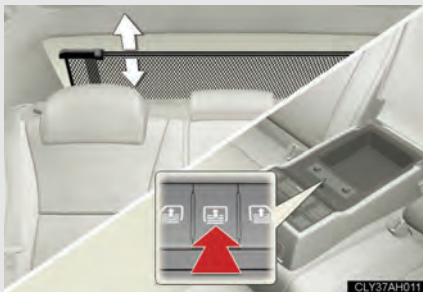

► From rear seat (4-seat models)



■ The rear sunshade can be used when

The “ENGINE START STOP” switch is in IGNITION ON mode.

■ Operating the rear sunshade after turning the “ENGINE START STOP” switch OFF

The rear sunshade can be operated for approximately 60 seconds even after the “ENGINE START STOP” switch is switched to ACCESSORY mode or turned OFF.

■ Reverse operation feature

To ensure adequate rear visibility, the rear sunshade automatically lowers when the shift lever is shifted to R.

However, the rear sunshade is raised again if any of the following occurs:

- The button is pressed again.
- The shift lever is shifted to P.
- The shift lever is shifted out of P and R, and the vehicle reaches a speed of 15 km/h (9 mph).

If the engine is turned off when the rear sunshade has been lowered due to the reverse operation feature, it will not be raised even when the engine is turned on again and the vehicle reaches a speed of 15 km/h (9 mph). To raise the sunshade again, press the button.

■ Button lock function

To prevent inadvertent operation, some buttons on the rear armrest can be locked. (→P. 226)

CAUTION

■ When the rear sunshade is being raised or lowered

Do not place fingers or other objects in the shade mechanism or in the opening as injury may result.

 NOTICE**■ To prevent the battery from being discharged**

Do not operate the rear sunshade when the engine is not running.

■ To ensure normal operation of the sunshade

Observe the following precautions.

- Do not place excessive load on the motor or other components.
- Do not place objects where they may hinder opening and closing operations.
- Do not attach items to the rear sunshade.
- Keep the opening clean and clear of obstructions.
- Do not operate the rear sunshade continuously for long periods of time.

3-8. Other interior features

Rear door sunshades (if equipped)

The rear door sunshades can be extended and retracted by operating any of the buttons shown below.

► From front seat

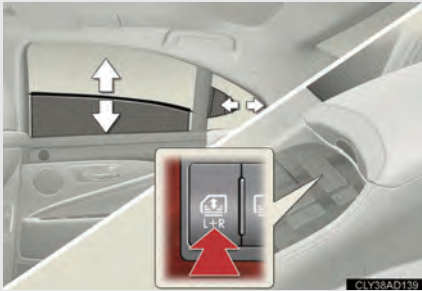

Extend/retract

The rear door sunshades can be extended only when both of left and right rear door sunshades are retracted. Pressing the button with either side retracted will cause both sides to be retracted.

► From rear seat (5-seat models)

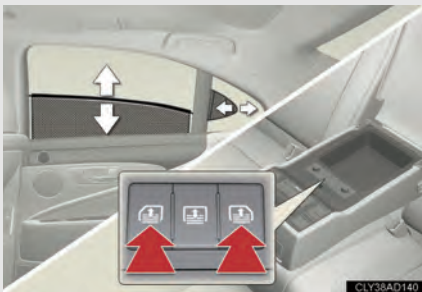

Extend/retract

► From rear seat (4-seat models)

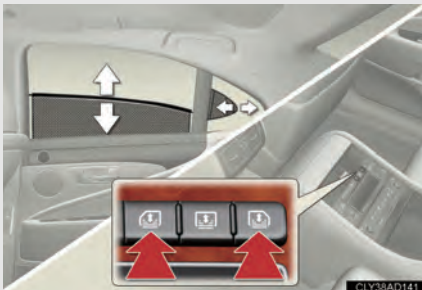

Extend/retract

■ Operating conditions

- The “ENGINE START STOP” switch is in IGNITION ON mode.
- The rear windows are fully closed.
The rear door sunshades automatically retract when the rear windows are opened.

■ Operating the rear door sunshades after turning the “ENGINE START STOP” switch off

The rear door sunshades can be operated for approximately 60 seconds after the “ENGINE START STOP” switch is switched to ACCESSORY mode or turned OFF.

■ Jam protection function

If an object becomes caught between a rear door sunshade and the window frame, the jam protection function will cause the sunshade to detach from its drive mechanism and retract.

▶ If the jam protection function operates when extending the rear door sunshades
Pressing the button will reconnect the sunshade.
Pressing the button again will allow the sunshades to be operated.
If the sunshade does not operate after the button is pressed, press the button again.

▶ If the jam protection function operates when retracting the rear door sunshades
Press and hold the button to re-extend the rear door sunshades, and continue pressing for more than 5 seconds after the sunshades have fully extended and stopped.

■ Button lock function

To prevent inadvertent operation, some buttons on the rear armrest can be locked.
(→P. 226)

■ When reconnecting the battery

The rear door sunshades will always be retracted the first time the button is pressed.

 **CAUTION**

■ **When the rear door sunshades are being extended or retracted**

Do not place fingers or other objects in the shade mechanism or in the opening as injury may result.

■ **Jam protection function**

Never use any part of your body to intentionally activate the jam protection function.

 **NOTICE**

■ **To prevent the battery from being discharged**

Do not operate the rear door sunshades when the engine is not running.

■ **To ensure normal operation of the sunshades**

Observe the following precautions.

- Do not place excessive load on the motor or other components.
- Do not place objects where they may hinder opening and closing operations.
- Do not attach items to the rear door sunshades.
- Keep the opening clean and clear of obstructions.
- Do not operate the rear door sunshades continuously for long periods of time.

3-8. Other interior features

Trunk storage extension (if equipped)

Long objects can be loaded in the vehicle by utilizing the trunk space and rear seat area.

STEP 1



Pull down the rear seat armrest.

STEP 2

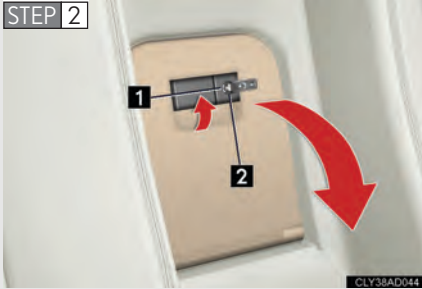

Open the armrest door.

The armrest door can be locked and unlocked using the mechanical key.

- 1** Lock
- 2** Unlock

► Opening from the cabin

STEP 3



Open the inside trunk door from the cabin or trunk, and load baggage or other items.

► Opening from the trunk

STEP 3



Open the inside trunk door from the cabin or trunk, and load baggage or other items.

 CAUTION

■ When not in use

Ensure that the inside trunk door is closed.

In the event of sudden braking, items stored in the trunk may be thrown forward into the cabin, resulting in injury.

Coat hooks

- ▶ Without rear air conditioning system

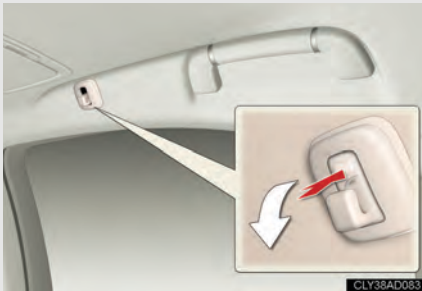

To use the coat hook, push it on.

- ▶ With rear air conditioning system

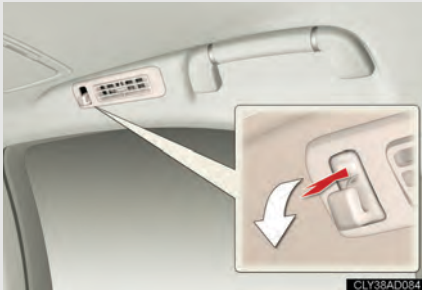

CAUTION

■ Items that must not be hung on the hook

Do not hang a coat hanger or other hard or sharp object on the hook. If the SRS curtain shield airbags deploy, these items may become projectiles that cause death or serious injury.

3-8. Other interior features

Floor mat

Securely place a mat that matches the size of the space on the carpet.



Secure the floor mat using the hooks provided.

CAUTION

■ When inserting the floor mat

Make sure the floor mat is properly placed on the floor carpet and the correct side faces upward. If the floor mat slips and interferes with the movement of the pedals during driving, it may cause an accident.

3-8. Other interior features

Trunk features

■ Cargo net



Cargo net is provided for securing loose items on the floor or items inside the trunk.

Raise the cargo hooks on the floor. Hook the net on the cargo hooks.

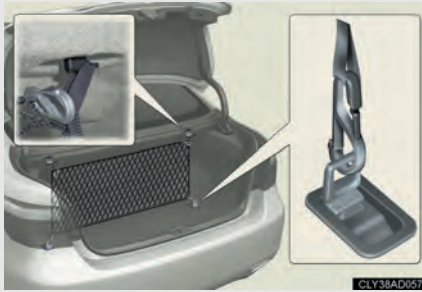

■ Shopping bag hooks

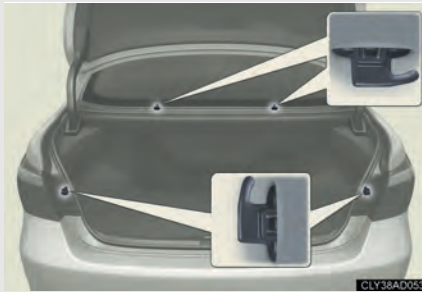

■ First-aid kit storage belt

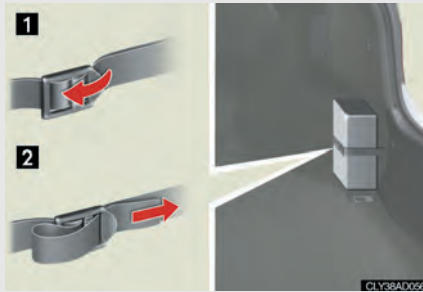

- 1 Loosen
- 2 Tighten

■ Luggage mat



Pull the lever upwards when lifting the luggage mat up.



The lever can be hooked on the edge of the trunk.

⚠ CAUTION

■ When the cargo net is not in use

To avoid injury, always return the cargo hooks on the floor to their positions when they are not in use.

 NOTICE**■ When closing the trunk**

Do not leave the luggage mat lever hooked on the edge of the trunk.
The luggage mat may get damaged.

4-1. Maintenance and care	430
Cleaning and protecting the vehicle exterior	430
Cleaning and protecting the vehicle interior	433
4-2. Maintenance	436
Maintenance requirements	436
Scheduled maintenance	439
4-3. Do-it-yourself maintenance	446
Do-it-yourself service precautions	446
Hood	449
Positioning the jack	450
Engine compartment	452
Tires	466
Tire inflation pressure	469
Wheels	471
Air conditioning filter	472
Electronic key battery	475
Checking and replacing fuses	477
Light bulbs	493

Cleaning and protecting the vehicle exterior

Perform the following to protect the vehicle and maintain it in prime condition.

- Working from top to bottom, liberally apply water to the vehicle body, wheel wells and underside of the vehicle to remove any dirt and dust.
Wash the vehicle body using a sponge or soft cloth, such as a chamois.
- For hard-to-remove marks, use car wash soap and rinse thoroughly with water.
- Wipe away any water.
- Wax the vehicle when the waterproof coating deteriorates.

If water does not bead on a clean surface, apply wax when the vehicle body is cool.

■ Automatic car washes

- Fold the mirrors back before washing the vehicle.
- Brushes used in automatic car washes may scratch the vehicle surface and harm your vehicle's paint.

■ High pressure car washes

- Do not allow the nozzles of the car wash to come within close proximity of the windows.
- Before car wash, check that the fuel filler door on your vehicle is closed properly.

■ Touch-up paint (if equipped)

Touch-up paint may be used to cover small chips or scratches.

Apply the paint soon after the damage occurs or corrosion may set in. To apply the touch-up paint so it is hardly noticeable the trick is to apply it only to the bare spots. Apply only the smallest amount possible and do not paint the surface around the scratch or chip.

■ Aluminum wheels

Remove any dirt immediately by using a neutral detergent. Do not use hard brushes or abrasive cleaners. Do not use strong or harsh chemical cleaners. Use the same mild detergent and wax as used on the paint.

■ Bumpers and side moldings

Do not scrub with abrasive cleaners.

■ To prevent deterioration and body corrosion

- Wash the vehicle immediately in the following cases:
 - After driving near the sea coast
 - After driving on salted roads
 - If you see coal tar or tree sap on the paint surface
 - If you see dead insects, insect droppings or bird droppings on the paint
 - After driving in an area contaminated with soot, oily smoke, mine dust, iron powder or chemical substances
 - If the vehicle becomes heavily soiled in dust or mud
 - If liquids such as benzene and gasoline are spilled on the paint surface
- If the paint is chipped or scratched, have it repaired immediately.

CAUTION

■ Caution about the exhaust pipes and rear bumper diffusers

Exhaust gasses cause the exhaust pipes and rear bumper diffusers to become quite hot.

When washing the vehicle, be careful not to touch the pipes and diffusers until they have cooled sufficiently, as touching a hot exhaust pipes and rear bumper diffusers can cause burns.

 NOTICE

■ **To protect your vehicle's painted surfaces**

Do not use organic cleaners such as benzene or gasoline.

■ **Cleaning the exterior lights**

- Wash carefully. Do not use organic substances or scrub with a hard brush. This may damage the surfaces of the lights.
- Do not apply wax on the surfaces of the lights. Wax may cause damage to the lenses.

■ **When using an automatic car wash**

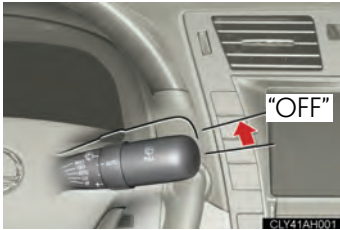

Set the wiper switch to "OFF". If the wiper switch is in "AUTO", the wipers may operate and the wiper blades may be damaged.

Cleaning and protecting the vehicle interior

The following procedures will help protect your vehicle's interior and keep it in top condition:

■ Protecting the vehicle interior

Remove dirt and dust using a vacuum cleaner. Wipe dirty surfaces with a cloth dampened with lukewarm water.

■ Cleaning the leather areas

- Remove dirt and dust using a vacuum cleaner.
- Wipe any excess dirt and dust with a soft cloth dampened with diluted detergent.

Use a diluted water solution of approximately 5% neutral wool detergent.

- Wring out any excess water from the cloth and thoroughly wipe off all remaining traces of detergent.
- Wipe the surface with a dry, soft cloth to remove any remaining moisture. Allow the leather to dry in a shaded ventilated area.

■ Synthetic leather areas

- Remove loose dirt using a vacuum cleaner.
- Apply a mild soap solution to the synthetic leather using a sponge or soft cloth.
- Allow the solution to soak in for a few minutes. Remove the dirt and wipe off the solution with a clean, damp cloth.

■ Cleaning the inside of the rear window

Do not use glass cleaner to clean the rear window, as this may cause damage to the rear window defogger heater wires or antenna. Use a cloth dampened with lukewarm water to gently wipe the window clean. Wipe the window in strokes running parallel to the heater wires or antenna.

■ Caring for leather areas

Lexus recommends cleaning the interior of the vehicle at least twice a year to maintain the quality of the vehicle's interior.

■ Shampooing the carpets

There are several commercial foaming-type cleaners available. Use a sponge or brush to apply the foam. Rub in overlapping circles. Do not apply water. Excellent results are obtained by keeping the carpet as dry as possible.

■ Seat belts

Clean with mild soap and lukewarm water using a cloth or sponge. Also check the belts periodically for excessive wear, fraying or cuts.

CAUTION

■ Water in the vehicle

- Be careful not to splash or spill liquid on the floor.
- Do not get any of the SRS components or wiring in the vehicle interior wet. (→P.105)

An electrical malfunction may cause the airbags to deploy or not function properly, resulting in death or severe injury.

 NOTICE**■ Cleaning detergents**

Do not use the following types of detergent, as they may discolor the vehicle interior or cause streaks or damage to painted surfaces:

- Non-seat portions: Organic substances such as benzene or gasoline, alkaline or acidic solutions, dye, or bleach
- Seats: Acidic solutions, such as thinner, benzene, or alcohol

■ Preventing damage to leather surfaces

Observe the following precautions to avoid damage to and deterioration of leather surfaces.

- Remove any dust or dirt on leather surfaces immediately.
- Do not expose the vehicle to direct sunlight for extended periods of time. Park the vehicle in the shade, especially during summer.
- Do not place items made of vinyl, plastic, or that contain wax on the upholstery, as they may stick to the leather surface if the vehicle interior heats up significantly.

■ Water on the floor

Do not wash the vehicle floor with water.

Vehicle systems such as the audio system may be damaged if water comes into contact with electrical components under the floor of the vehicle, and may also cause the body to rust.

■ Cleaning the inside of the rear window

Be careful not to scratch or damage the heater wires or antenna.

Maintenance requirements

To ensure safe and economical driving, day-to-day care and regular maintenance is essential. Lexus recommends the following maintenance.

■ Scheduled maintenance

- Should be performed at specified intervals according to the maintenance schedule.

The service interval for scheduled maintenance is determined by the odometer reading or the time interval, whichever comes first, shown in the schedule.

The maintenance service beyond the last period should be performed at the same intervals.

- Where to go for service?

It makes good sense to take your vehicle to your local Lexus dealer for service.

Lexus technicians are well-trained specialists. And they are receiving the latest service information through technical bulletins, service tips, and in-dealership training programs. They learn to work on Lexus before they work on your vehicle, rather than while they are working on it. Doesn't that seem like the best way?

Your Lexus dealer has invested a lot of money in special Lexus tools and service equipment. It helps do the job better and at less cost.

Your Lexus dealer's service department will perform all of the scheduled maintenance on your vehicle - reliably and economically.

Rubber hoses (for cooling and heater system, brake system and fuel system) should be inspected by a qualified technician in accordance with the Lexus maintenance schedule.

They are particularly important maintenance items. Have any deteriorated or damaged hoses replaced immediately. Note that rubber hoses will deteriorate with age, resulting in swelled, chafed or cracked condition.

■ Do-it-yourself maintenance

What about do-it-yourself maintenance?

Many of the maintenance items are easy to do yourself if you have a little mechanical ability and a few basic automotive tools. Simple instructions for how to perform them are presented in this section.

Note, however, that some maintenance tasks require special tools and skills. These are best performed by qualified technicians. Even if you are an experienced do-it-yourself mechanic, we recommend that repairs and maintenance be conducted by your Lexus dealer who will keep a record of maintenance on your Lexus. This record could be helpful should you ever require Warranty Service.

■ Does your vehicle need repair?

Be on the alert for changes in performance and sounds, and visual tip-offs that indicate service is needed. Some important clues are:

- Engine missing, stumbling, or pinging
- Appreciable loss of power
- Strange engine noises
- A fluid leak under the vehicle (However, water dripping from the air conditioning after use is normal.)
- Change in exhaust sound (This may indicate a dangerous carbon monoxide leak. Drive with the windows open and have the exhaust system checked immediately.)
- Flat-looking tires, excessive tire squeal when cornering, uneven tire wear
- Vehicle pulls to one side when driving straight on a level road
- Strange noises related to suspension movement
- Loss of brake effectiveness, spongy feeling brake pedal, pedal almost touches floors, vehicle pulls to one side when braking
- Engine coolant temperature continually higher than normal

If you notice any of these clues, take your vehicle to your Lexus dealer, as soon as possible. Your vehicle may need adjustment or repair.

 **CAUTION**

■ **If your vehicle is not properly maintained**

It could result in serious damage to the vehicle and possible personal injury or death.

■ **Warning in handling of the battery**

Battery posts, terminals and related accessories contain lead and lead compounds which are known to cause brain damage. Wash your hands after handling.
(→P. 462)

■ **Used engine oil**

Used engine oil contains chemicals that have been shown to cause cancer in laboratory animals. Avoid prolonged and repeated contact. Always protect your skin by washing thoroughly with soap and water.

Scheduled maintenance

Perform maintenance by the schedule as follows:

Maintenance schedule requirements

Your Lexus needs to be serviced in accordance with the normal maintenance schedule (See "Maintenance schedule").



If you mainly operate your Lexus under one or more of the special operating conditions below, some of the maintenance schedule items need to be serviced more frequently (See "Additional maintenance schedule").

- | A. Road Condition | B. Driving Condition |
|---|--|
| <ol style="list-style-type: none"><li data-bbox="176 807 544 866">1. Operating on rough, muddy or melted snow roads<li data-bbox="176 874 488 906">2. Operating on dusty roads | <ol style="list-style-type: none"><li data-bbox="598 807 964 866">1. Using a camper or car top carrier<li data-bbox="598 874 964 1002">2. Repeated short trips less than 8 km (5 miles) and outside temperature remains below freezing<li data-bbox="598 1010 964 1137">3. Extensive idling and/or low speed driving for a long distance such as police cars, taxis or door-to-door calls.<li data-bbox="598 1145 964 1273">4. Continuous high speed driving (80 % or more of maximum vehicle speed) for over 2 hours |

Maintenance schedule

Maintenance operations: I = Inspect and correct or replace as necessary;
R = Replace, change or lubricate

SERVICE INTERVAL:		ODOMETER READING										MONTHS
(Odometer reading or months, whichever comes first.)	x1000 km	1	10	20	30	40	50	60	70	80		
	x1000 miles	0.6	6	12	18	24	30	36	42	48		
BASIC ENGINE COMPONENTS												
1	Drive belts			I		I		I		I	24	
2	Engine oil (API SL, SM, or ILSAC)		R	R	R	R	R	R	R	R	12	
3	Engine oil filter		R	R	R	R	R	R	R	R	12	
4	Cooling and heater system <<See notes 1 and 2.>>					I				I	24	
5	Engine coolant <<See notes 3, 4 and 5.>>					I				I	-	
6	Exhaust pipe and mountings			I		I		I		I	12	
IGNITION SYSTEM												
7	Spark plugs	Replace every 100000 km (60000 miles)									-	
8	Battery		I	I	I	I	I	I	I	I	12	
FUEL AND EMISSION CONTROL SYSTEMS												
9	Fuel filter <<See note 6.>>	Replace at every 60000 km									72	
10	Air cleaner filter			I		R		I		R	I:24 R:48	
11	Fuel tank cap, fuel lines, connections and fuel vapor control valve <<See note 1.>>					I				I	24	
12	Charcoal canister					I				I	24	

Maintenance operations:

I = Inspect and correct or replace as necessary;
R = Replace, change or lubricate

SERVICE INTERVAL:		ODOMETER READING										MONTHS
(Odometer reading or months, whichever comes first.)	x1000 km	1	10	20	30	40	50	60	70	80		
	x1000 miles	0.6	6	12	18	24	30	36	42	48		
CHASSIS AND BODY												
13	Brake pedal and parking brake		I	I	I	I	I	I	I	I	6	
14	Brake linings and drums			I		I		I		I	12	
15	Brake pads and discs		I	I	I	I	I	I	I	I	6	
16	Brake fluid		I	I	I	R	I	I	I	R	I:6 R:24	
17	Brake line pipes and hoses			I		I		I		I	12	
18	Steering wheel, linkage and gear box			I		I		I		I	12	
19	Drive shaft boots			I		I		I		I	24	
20	Ball joint and dust cover			I		I		I		I	12	
21	Automatic transmission fluid					I				I	24	
22	Rear differential oil			I		R		I		R	I:12 R:48	
23	Front and rear suspension			I		I		I		I	12	
24	Tires and inflation pressure		I	I	I	I	I	I	I	I	6	
25	All lights, horns, wipers and washers		I	I	I	I	I	I	I	I	6	

Maintenance operations:

I = Inspect and correct or replace as necessary;
R = Replace, change or lubricate

SERVICE INTERVAL:		ODOMETER READING									MONTHS
(Odometer reading or months, whichever comes first.)	x1000 km	1	10	20	30	40	50	60	70	80	
	x1000 miles	0.6	6	12	18	24	30	36	42	48	
26	Air conditioning filter	When a message on the multi-information display indicates that maintenance is required, replace the filter.									
AIR CONDITIONING/COOLER REFRIGERANT				I		I		I		I	12

NOTE:

1. After 80000 km (48000 miles) or 48 months, inspect every 20000 km (12000 miles) or 12 months.
2. Check that the radiator and condenser are not blocked with leaves, dirt, or insects, and clean the hose connection.
3. First replace at 160000 km (100000 miles), then replace at every 80000 km (50000 miles).
4. Only use “Toyota Super Long Life Coolant” or similar high quality ethylene glycol based non-silicate, non-amine, non-nitrite, and non-borate coolant with long-life hybrid organic acid technology. (Coolant with long-life hybrid organic acid technology consists of the combination of low phosphates and organic acids.)
5. It is not necessary to inspect the “Toyota Super Long Life Coolant” level when replacing the “Toyota Super Long Life Coolant”.
6. Including the filter in fuel tank.

Additional maintenance schedule

Refer to the following table for normal maintenance schedule items requiring more frequent service specific to the type of severe conditions. (For outline, see “Maintenance schedule requirements”).

A-1: Operating on rough, muddy or melted snow roads	
<input type="checkbox"/> Inspection of brake linings and drums	Every 10000 km (6000 miles) or 6 months
<input type="checkbox"/> Inspection of brake pads and discs	Every 5000 km (3000 miles) or 3 months
<input type="checkbox"/> Inspection of brake line pipes and hoses	Every 10000 km (6000 miles) or 6 months
<input type="checkbox"/> Inspection of ball joints and dust covers	Every 10000 km (6000 miles) or 6 months
<input type="checkbox"/> Inspection of drive shaft boots	Every 10000 km (6000 miles) or 12 months
<input type="checkbox"/> Inspection of steering wheel, linkage and steering gear box	Every 5000 km (3000 miles) or 3 months
<input type="checkbox"/> Inspection of front and rear suspension	Every 10000 km (6000 miles) or 6 months
<input type="checkbox"/> Tightening of bolts and nuts on chassis and body <<See note.>>	Every 10000 km (6000 miles) or 6 months

A-2: Operating on dusty roads	
<input type="checkbox"/> Replacement of engine oil	Every 5000 km (3000 miles) or 6 months
<input type="checkbox"/> Replacement of engine oil filter	Every 5000 km (3000 miles) or 6 months
<input type="checkbox"/> Inspection or replacement of air cleaner filter	I: Every 2500 km (1500 miles) or 3 months R: Every 40000 km (24000 miles) or 48 months
<input type="checkbox"/> Inspection of brake linings and drums	Every 10000 km (6000 miles) or 6 months
<input type="checkbox"/> Inspection of brake pads and discs	Every 5000 km (3000 miles) or 3 months
B-1: Using a camper or car top carrier	
<input type="checkbox"/> Replacement of engine oil	Every 5000 km (3000 miles) or 6 months
<input type="checkbox"/> Replacement of engine oil filter	Every 5000 km (3000 miles) or 6 months
<input type="checkbox"/> Inspection of brake linings and drums	Every 10000 km (6000 miles) or 6 months
<input type="checkbox"/> Inspection of brake pads and discs	Every 5000 km (3000 miles) or 3 months
<input type="checkbox"/> Inspection or replacement of automatic transmission fluid	I: Every 40000 km (24000 miles) or 24 months R: Every 80000 km (48000 miles) or 48 months
<input type="checkbox"/> Inspection of front and rear suspension	Every 10000 km (6000 miles) or 6 months
<input type="checkbox"/> Tightening of bolts and nuts on chassis and body <<See note.>>	Every 10000 km (6000 miles) or 6 months

B-2: Repeated short trips less than 8 km (5 miles) and outside temperature remains below freezing	
<input type="checkbox"/> Replacement of engine oil	Every 5000 km (3000 miles) or 6 months
<input type="checkbox"/> Replacement of engine oil filter	Every 5000 km (3000 miles) or 6 months
B-3: Extensive idling and/or low speed driving for a long distance such as police cars, taxis or door-to-door calls	
<input type="checkbox"/> Replacement of engine oil	Every 5000 km (3000 miles) or 6 months
<input type="checkbox"/> Replacement of engine oil filter	Every 5000 km (3000 miles) or 6 months
<input type="checkbox"/> Inspection of brake linings and drums	Every 10000 km (6000 miles) or 6 months
<input type="checkbox"/> Inspection of brake pads and discs	Every 5000 km (3000 miles) or 3 months
B-4: Continuous high speed driving (80% or more at maximum vehicle speed) for over 2 hours	
<input type="checkbox"/> Inspection or replacement of automatic transmission fluid	I: Every 40000 km (24000 miles) or 24 months R: Every 80000 km (48000 miles) or 48 months

NOTE: For seat mounting bolts, front and rear suspension member retaining bolts.

4-3. Do-it-yourself maintenance

Do-it-yourself service precautions

If you perform maintenance yourself, be sure to follow the correct procedures as given in these sections.

Items	Parts and tools
Battery condition (→P. 462)	<ul style="list-style-type: none">• Warm water• Baking soda• Grease• Conventional wrench (for terminal clamp bolts)
Engine coolant level (→P. 460)	<ul style="list-style-type: none">• Toyota Super Long Life Coolant or similar high quality ethylene glycol based non-silicate, non-amine, non-nitrite and non-borate coolant with long-life hybrid organic acid technology <p>Toyota Super Long Life Coolant is pre-mixed with 50% coolant and 50% deionized water.</p> <ul style="list-style-type: none">• Funnel (used only for adding coolant)
Engine oil level (→P. 456)	<ul style="list-style-type: none">• Toyota Genuine Motor Oil or equivalent• Rag or paper towel, funnel (used only for adding oil)
Fuses (→P. 477)	<ul style="list-style-type: none">• Fuse with same amperage rating as original
Radiator and condenser (→P. 462)	—

Items	Parts and tools
Tire inflation pressure (→P. 469)	<ul style="list-style-type: none"> • Tire pressure gauge • Compressed air source
Washer fluid (→P. 465)	<ul style="list-style-type: none"> • Water washer fluid containing anti-freeze (for winter use) • Funnel

CAUTION

The engine compartment contains many mechanisms and fluids that may move suddenly, become hot, or become electrically energized. To avoid death or serious injury, observe the following precautions:

■ When working on the engine compartment

- Keep hands, clothing, and tools away from the moving fans and engine drive belt.
- Be careful not to touch the engine, radiator, exhaust manifold, etc. right after driving as they may be hot. Oil and other fluids may also be hot.
- Do not leave anything that may burn easily, such as paper or rags, in the engine compartment.
- Do not smoke, cause sparks or expose an open flame to fuel or the battery. Fuel and battery fumes are flammable.
- Be extremely cautious when working on the battery. It contains poisonous and corrosive sulfuric acid.
- Take care because brake fluid can harm your hands or eyes and damage painted surfaces.

If fluid gets on your hands or in your eyes, flush the affected area with clean water immediately.

If you still experience discomfort, see a doctor.

 **CAUTION**

■ **When working near the electric cooling fan or radiator grille**

Be sure the “ENGINE START STOP” switch is OFF.

With the “ENGINE START STOP” switch in IGNITION ON mode, the electric cooling fan may automatically start to run if the air conditioning is on and/or the coolant temperature is high.

(→P. 462)

■ **Safety glasses**

Wear safety glasses to prevent flying or falling material, fluid spray, etc. from getting in the eyes.

 **NOTICE**

■ **If you remove the air cleaner**

Driving with the air cleaners removed may cause excessive engine wear due to dirt in the air. Also a backfire could cause a fire in the engine compartment.

■ **If the fluid level is low or high**

It is normal for the brake fluid level to go down slightly as the brake pads wear or when the fluid level in the accumulator is high.

If the reservoir needs frequent refilling, it may indicate a serious problem.

4-3. Do-it-yourself maintenance

Hood

Release the lock from the inside of the vehicle to open the hood.

STEP 1



Pull the hood release lever.
The hood will pop up slightly.

STEP 2



Lift the hood catch and lift the hood.

CAUTION

■ Pre-driving check

Check that the hood is fully closed and locked.

If the hood is not locked properly, it may open while the vehicle is in motion and cause an accident, which may result in death or serious injury.

4-3. Do-it-yourself maintenance

Positioning the jack

When raising your vehicle with the jack, position the jack correctly. Improper placement may damage your vehicle or cause injury.

■ Front



■ Rear



⚠ CAUTION

■ When raising your vehicle

Make sure to observe the following to reduce the possibility of death or serious injury:

- Do not put any part of your body or get underneath the vehicle supported only by the jack.
Always use automotive jack stands on a solid, level surface.
- Do not start the engine while the vehicle is supported by the jack.
- Stop the vehicle on level firm ground, set the parking brake and put the shift lever in P.

 **CAUTION**

- Make sure to set the jack properly at the jack point.
Raising the vehicle with an improperly positioned jack will damage the vehicle and may cause the vehicle to fall off the jack.
- Do not raise the vehicle while someone is in the vehicle.
- When raising the vehicle, do not place any objects on top of or underneath the jack.

4-3. Do-it-yourself maintenance

Engine compartment

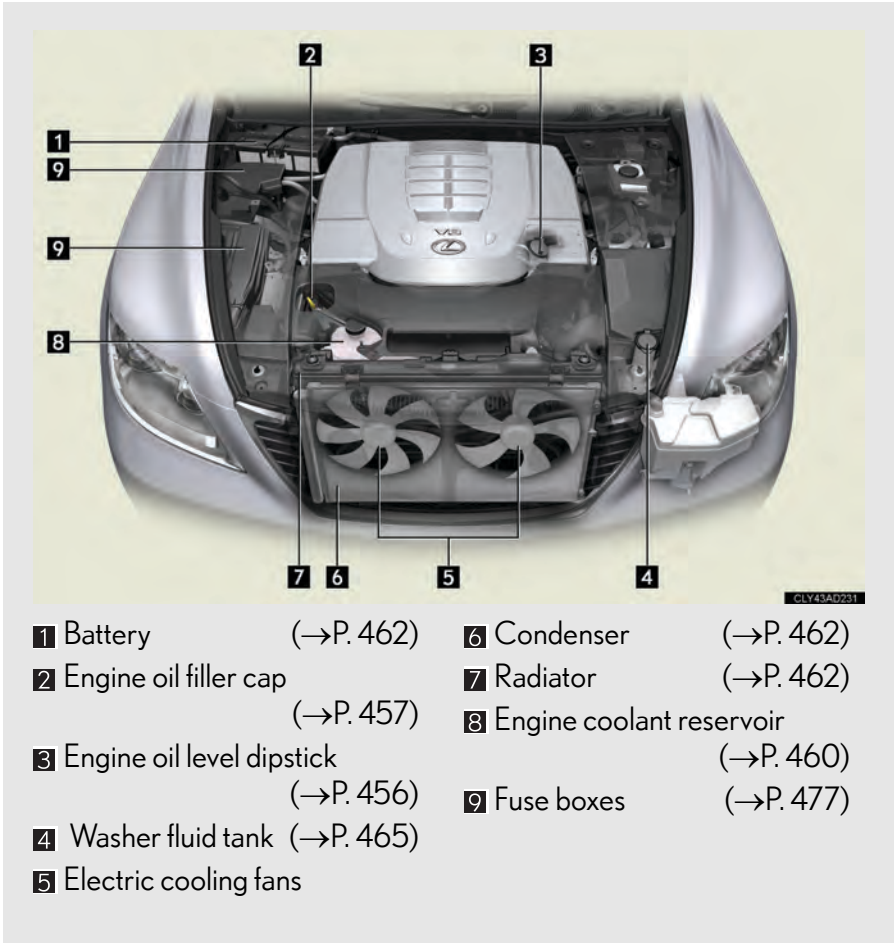

- | | | | |
|------------------------------------|-----------|-----------------------------------|-----------|
| 1 Battery | (→P. 462) | 6 Condenser | (→P. 462) |
| 2 Engine oil filler cap | (→P. 457) | 7 Radiator | (→P. 462) |
| 3 Engine oil level dipstick | (→P. 456) | 8 Engine coolant reservoir | (→P. 460) |
| 4 Washer fluid tank | (→P. 465) | 9 Fuse boxes | (→P. 477) |
| 5 Electric cooling fans | | | |

Engine compartment cover

■ Removing the engine compartment covers

▶ Outside

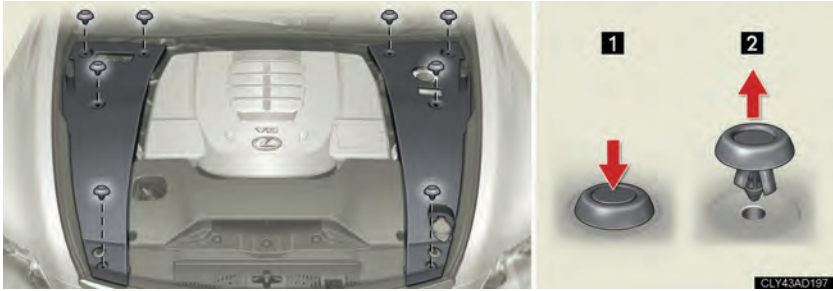

▶ Front

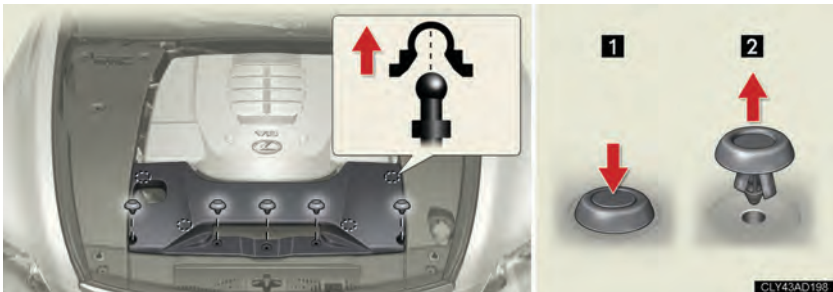

■ Installing the clips

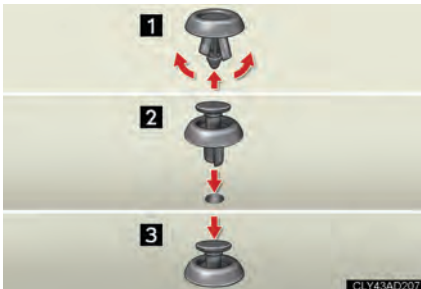

Battery cover

■ Removing the battery cover



■ Installing the clips

▶ Type A

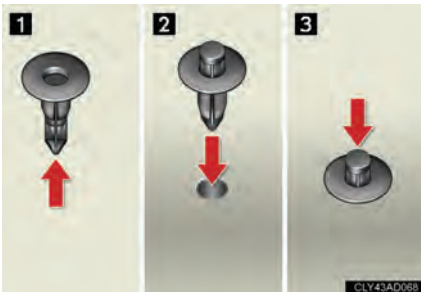

▶ Type B

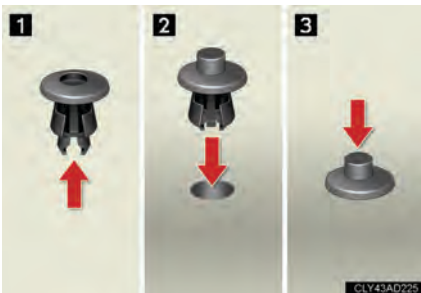

 NOTICE**■ When installing the battery cover**

Securely install the cover over the battery. Failure to do so may cause water to enter the engine compartment when it rains or the vehicle is washed, resulting in a malfunction.

Engine oil

With the engine at operating temperature and turned off, check the oil level on the dipstick.

■ Checking the engine oil

STEP 1 Park the vehicle on level ground. After turning off the engine, wait a few minutes for the oil to drain back into the bottom of the engine.

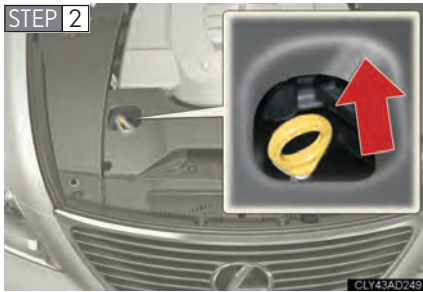

Hold a rag under the end and pull the dipstick out.

STEP 3 Wipe the dipstick clean.

STEP 4 Reinsert the dipstick fully.

STEP 5 Holding a rag under the end, pull the dipstick out and check the oil level.

STEP 6 Wipe the dipstick and reinsert it fully.

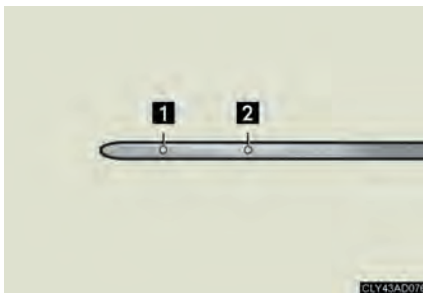

- 1** Low
- 2** Full

■ Adding engine oil



If the oil level is below or near the low level mark, add engine oil of the same type as already in the engine.

Make sure to check the oil type and prepare the items needed before adding oil.

Oil grade	20W-50 and 15W-40: API grade SL or SM multigrade engine oil 10W-30, 5W-30, 5W-20 and 0W-20: API grade SL "Energy-Conserving", SM "Energy-Conserving" or ILSAC multigrade engine oil
Items	Clean funnel

STEP 1 Remove the oil filler cap.

STEP 2 Add engine oil slowly, checking the dipstick.

STEP 3 Install the filler cap, turning it clockwise.

About 1.5 L (1.6 qt., 1.3 Imp. qt.) is required to raise the oil level from low to full on the dipstick.

■ Recommended viscosity

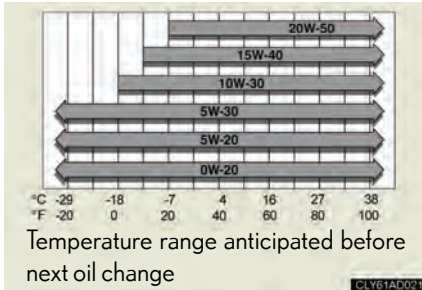

■ How to read oil container labels

One or both API registered marks are added to some oil containers to help you select the proper oil.

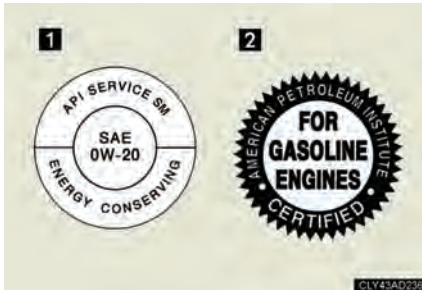

1 API Service Symbol

Top portion: The oil quality designation by API (American Petroleum Institute) (SM)

Center portion: The SAE viscosity grade (SAE 0W-20)

Lower portion: “Energy-Conserving” means that the oil has fuel-saving capabilities.

2 ILSAC Certification Mark

■ Engine oil consumption

- The amount of engine oil consumed depends on the oil viscosity, the quality of the oil and the way the vehicle is driven.
- More oil is consumed under driving conditions such as high speeds, frequent acceleration and deceleration.
- A new engine consumes more oil.
- When judging the amount of oil consumption, keep in mind that the oil may have become diluted, making it difficult to judge the true level accurately.
- Oil consumption: Max. 1.0 L per 1000 km (1.1 qt./600 miles, 0.9 Imp.qt./600 miles)
- If your vehicle consumes more than 1.0 L (1.1 qt., 0.9 Imp.qt.) every 1000 km (600 miles), contact your Lexus dealer.

CAUTION

■ Used engine oil

- Used engine oil contains potentially harmful contaminants which may cause skin disorders such as inflammation or skin cancer, so care should be taken to avoid prolonged and repeated contact. To remove used engine oil from your skin, wash thoroughly with soap and water.
- Dispose of used oil and filters only in a safe and acceptable manner. Do not dispose of used oil and filters in household trash, in sewers or onto the ground. Call your Lexus dealer, service station or auto parts store for information concerning recycling or disposal.
- Do not leave used engine oil within the reach of children.

 NOTICE

■ **To prevent serious engine damage**

Check the oil level on regular basis.

■ **When replacing the engine oil**

- Be careful not to spill engine oil on the vehicle components.
- Avoid overfilling, as the engine could be damaged.
- Check the oil level on the dipstick every time you refill the vehicle.
- Be sure the engine oil filler cap is properly tightened.

Engine coolant

The coolant level is satisfactory if it is between the FULL and LOW lines on the reservoir when the engine is cold.

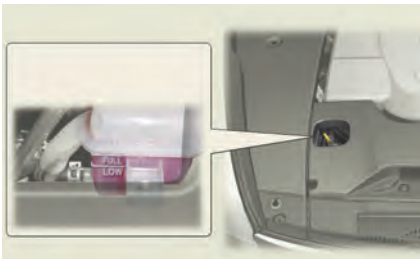

1 Reservoir cap

2 FULL

3 LOW

If the level is on or below the LOW line, add coolant up to the FULL line. (→P. 541)



■ If the coolant level drops within a short time after replenishing

Visually check the radiator, hoses, coolant reservoir cap, drain cock and water pump.

If you cannot find a leak, have your Lexus dealer test the cap and check for leaks in the cooling systems.

■ Coolant selection

Only use Toyota Super Long Life Coolant or similar high quality ethylene glycol based non-silicate, non-amine, non-nitrite, and non-borate coolant with long-life hybrid organic acid technology.

Toyota Super Long Life Coolant is a mixture of 50% coolant and 50% deionized water. (Minimum temperature: -35°C [-31°F])

For more details about engine coolant, contact your Lexus dealer.

CAUTION

■ When the engine is hot

Do not remove the coolant reservoir cap.

The cooling system may be under pressure and may spray hot coolant if the cap is removed, causing burns or other injuries.

NOTICE

■ When adding engine coolant

Coolant is neither plain water nor straight antifreeze. The correct mixture of water and antifreeze must be used to provide proper lubrication, corrosion protection and cooling. Be sure to read the antifreeze or coolant label.

■ If you spill coolant

Be sure to wash it off with water to prevent damage to parts or paint.

Radiator and condenser

Check the radiator and condenser, and clear any foreign objects.
If any of the above parts are extremely dirty or you are not sure of their condition, have your vehicle checked by your Lexus dealer.

CAUTION

The radiators and condenser may be hot after driving

Do not touch the radiator or condenser, as they may be hot and may cause burns.

Battery

Check the battery as follows.

Battery exterior

Make sure that the battery terminals are not corroded and that there are no loose connections, cracks, or loose clamps.

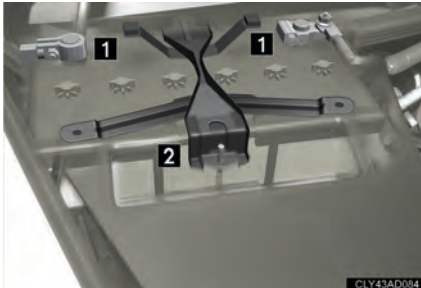

 Terminals

 Hold-down clamp

■ Checking battery condition

STEP 1 Remove the cover located over the battery. (→P. 454)

STEP 2 Check the battery condition using the indicator color.

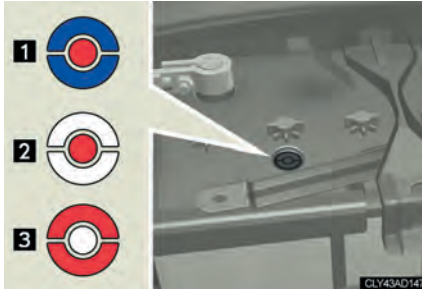

1 Blue: Good condition

2 White: Charging is necessary. Have the vehicle inspected by your Lexus dealer.

3 Red: Not working properly have the battery checked by your Lexus dealer.

STEP 3 Install the cover over the battery. (→P. 454)

■ Before recharging

When recharging, the battery produces hydrogen gas which is flammable and explosive. Therefore, observe the following before recharging:

- If recharging with the battery installed on the vehicle, be sure to disconnect the ground cable.
- Make sure the power switch on the charger is off when connecting and disconnecting the charger cables to the battery.

 **CAUTION**

■ **Chemicals in the battery**

A battery contains poisonous and corrosive sulfuric acid and may produce hydrogen gas which is flammable and explosive. To reduce the risk of death or serious injury, take the following precautions while working on or near battery:

- Do not cause sparks by touching the battery terminals with tools.
- Do not smoke or light a match near the battery.
- Avoid contact with eyes, skin and clothes.
- Never inhale or swallow electrolyte.
- Wear protective safety glasses when working near the battery.
- Keep children away from the battery.

■ **Where to safely charge the battery**

Always charge the battery in an open area. Do not charge the battery in a garage or closed room where there is not sufficient ventilation.

■ **Emergency measures regarding electrolyte**

- If electrolyte gets in your eyes
Flush your eyes with clean water for at least 15 minutes and get immediate medical attention. If possible, continue to apply water with a sponge or cloth while traveling to the nearest medical facility.
- If electrolyte gets on your skin
Wash the affected area thoroughly. If you feel pain or burning, get medical attention immediately.
- If electrolyte gets on your clothes
It can soak through clothing on to your skin. Immediately take off the clothing and follow the procedure above if necessary.
- If you accidentally swallow electrolyte
Drink a large quantity of water or milk. Follow with milk of magnesia, beaten raw egg or vegetable oil. Get emergency medical attention immediately.

 NOTICE

■ **When recharging the battery**

Never recharge the battery while the engine is running. Also, be sure all accessories are turned off.

■ **When replacing the battery**

Replace the battery with a battery of the same size.

Installing a battery of a different size will prevent the cover from being properly installed over the battery. This may cause water to enter the engine compartment when it rains or the vehicle is washed, resulting in a malfunction.

For more information about replacing the battery, contact your Lexus dealer.

Washer fluid



If any washer does not work or the warning message appears on the multi-information display, the washer tank may be empty. Add washer fluid.

 NOTICE

■ **Do not use any fluid other than washer fluid**

Do not use soapy water or engine antifreeze instead of washer fluid. Doing so may cause streaking on the vehicle's painted surfaces.

■ **Diluting washer fluid**

Dilute washer fluid with water as necessary.

Refer to the freezing temperatures listed on the washer fluid tank.

4-3. Do-it-yourself maintenance

Tires

Replace the tires when the treadwear indicators show.

■ Checking tires



- 1 New tread
- 2 Treadwear indicator
- 3 Worn tread

The location of treadwear indicators is shown by the TWI or \triangle marks, etc., molded on the sidewall of each tire.

Check spare tire condition and inflation pressure if not rotated.

■ Tire rotation

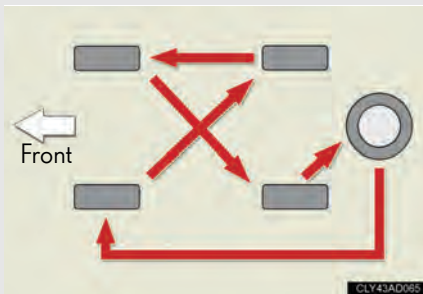

Rotate the tires in the order shown.

To equalize tire wear and extend tire life, Lexus recommends that tire rotation is carried out at the same interval as tire inspection.

■ When to replace your vehicle's tires

Tires should be replaced if:

- You have tire damage such as cuts, splits, cracks deep enough to expose the fabric or bulges indicating internal damage.
- A tire goes flat repeatedly or cannot be properly repaired due to the size or location of a cut or other damage.

If you are not sure, consult with your Lexus dealer.

■ Tire life

Any tire over 6 years old must be checked by a qualified technician even if they have seldom or never been used or damage is not obvious.

■ If the tread wears down 4 mm (0.16 in.) or more on snow tires

The effectiveness of the tires as snow tires is lost.

CAUTION

■ When inspecting or replacing tires

Observe the following precautions to prevent accidents.

Failure to do so may cause damage to parts of the drive train, as well as dangerous handling characteristics, which may lead to fatal or injury accidents.

- Do not mix tires of different makes, models, tread patterns or treadwear.
- Do not use tire sizes other than those recommended by Lexus.
- Do not mix radial, bias-belted, or bias-ply tires.
- Do not mix summer, all season and winter tires.
- Do not use tires that have been used on another vehicle.
Do not use tires if you do not know how they were used previously.

 NOTICE

■ **Driving on rough roads**

Take particular care when driving on roads with loose surfaces or pot holes. These conditions may cause losses in tire air pressure, reducing the cushioning ability of the tires. In addition, driving on rough roads may cause damage to the tires themselves, as well as the vehicle's wheels and body.

■ **If tire pressures become low while driving**

Do not continue driving, or your tires and/or wheels may be ruined.

4-3. Do-it-yourself maintenance

Tire inflation pressure

Make sure to maintain the proper tire inflation pressure. Tire inflation pressure should be checked at least once per month. However, Lexus recommends that tire inflation pressure be checked once every two weeks. (→P. 553)

■ Effects of incorrect tire inflation pressure

Driving with incorrect tire inflation pressure may result in the following:

- Reduced fuel efficiency
- Reduced driving comfort and tire life
- Reduced safety
- Damage to the drive train

If a tire needs frequent refilling, have it checked by your Lexus dealer.

■ Instructions for checking tire pressure

When checking tire inflation pressure, observe the following:

- Check only when the tires are cold.
If your vehicle has been parked for at least 3 hours and has not been driven for more than 1.5 km or 1 mile, you will get an accurate cold tire inflation pressure reading.
- Always use a tire pressure gauge.
The appearance of the tire can be misleading. In addition, tire inflation pressures that are even just a few pounds off can degrade ride and handling.
- Do not bleed or reduce tire inflation pressure after driving. It is normal for the tire inflation pressure to be higher after driving.
- Never exceed the vehicle capacity weight.
Passengers and luggage weight should be placed so that the vehicle is balanced.

 **CAUTION**

■ Proper inflation is critical to save tire performance

Keep your tires properly inflated. Otherwise, the following conditions may occur and result in an accident causing death or serious injury:

- Excessive wear
- Uneven wear
- Poor handling
- Possibility of blowouts resulting from overheated tires
- Poor sealing of the tire bead
- Wheel deformation and/or tire separation
- A greater possibility of tire damage from road hazards

 **NOTICE**

■ When inspecting and adjusting tire pressure

Be sure to reinstall the tire valve caps.

Without the valve caps, dirt or moisture could get into the valve and cause air leakage, which could result in an accident. If the caps have been lost, replace them as soon as possible.

Wheels

If a wheel is bent, cracked or heavily corroded, it should be replaced. Otherwise, the tire may separate from the wheel or cause loss of handling control.

■ Wheel selection

When replacing wheels, care should be taken to ensure that they are equivalent to those removed in load capacity, diameter, rim width, and offset.

Replacement wheels are available at your Lexus dealer.

Lexus does not recommend using the following:

- Wheels of different sizes or types
- Used wheels
- Bent wheels that have been straightened

■ Aluminum wheel precautions

- Use only Lexus wheel nuts and wrenches designed for use with your aluminum wheels.
- When rotating, repairing or changing your tires, check that the wheel nuts are still tight after driving 1600 km (1000 miles).
- Be careful not to damage the aluminum wheels when using tire chains.
- Use only Lexus genuine balance weights or equivalent and a plastic or rubber hammer when balancing your wheels.

CAUTION

■ When replacing wheels

- Do not use wheels that are a different size from those recommended in the Owner's Manual, as this may result in loss of handling control.
- Never use an inner tube in a leaking wheel which is designed for a tubeless tire. Doing so may result in an accident, causing serious injury or death.

4-3. Do-it-yourself maintenance

Air conditioning filter

The air conditioning filter must be changed regularly to maintain air conditioning efficiency.

■ Front air conditioning filter

STEP 1 Set the air conditioning system to recirculated mode.
(→P. 207, 216)

The air conditioning filter case cannot be removed with the system in the outside air mode.

STEP 2 Turn the “ENGINE START STOP” switch OFF.

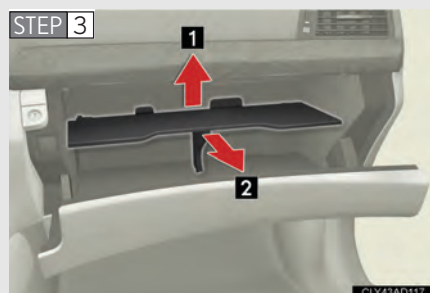

Open the glove box. Lift and remove the partition.



Remove the filter cover.

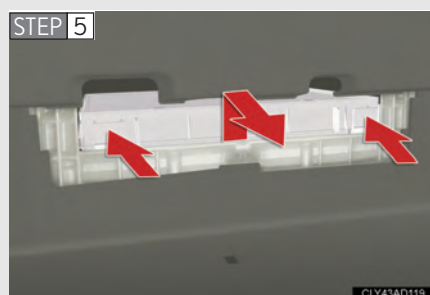

Remove the filter case.

STEP 6

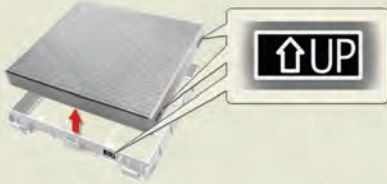

CLY43AD201

Remove the air conditioning filter from the filter case and replace it with a new one.

The ↑UP marks shown on the filter and the filter case should be pointing up.

STEP 7 Reset the air conditioning filter maintenance data. (→P. 474)

■ Rear air conditioning filter (if equipped)

STEP 1 Turn the “ENGINE START STOP” switch OFF.

STEP 2



CLY43AD121

Open the trunk lid. Remove the filter cover.

STEP 3

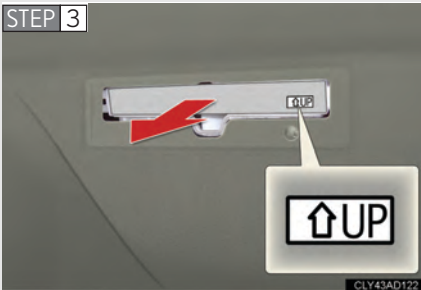

CLY43AD122

Remove the air conditioning filter and replace it with a new one.

The ↑UP marks shown on the filter should be pointing up.

■ Changing interval for the front air conditioning filter

Inspect and replace the air conditioning filter when a message is appeared on the multi-information display. In dusty areas or areas with heavy traffic flow, early replacement may be required.

■ If air flow from the vents decreases dramatically

The filter may be clogged. Check the filter and replace if necessary.

■ After changing the air conditioning filter

The air conditioning filter maintenance date should be reset. Perform the following procedures:

STEP 1 Turn the “ENGINE START STOP” switch to IGNITION ON mode.

STEP 2 Press and hold  (on the air conditioning panel) for 4 seconds or more.

If the air conditioning filter maintenance date is not reset, a message will be shown on the multi-information display each time the engine is turned to IGNITION ON mode.

■ Rear air conditioning filter (if equipped)

If it is necessary to clean or replace the filter, contact your Lexus dealer.

■ Climate control seat filter

On vehicles with climate control seats, filters are installed in the seats. When it is necessary to clean or replace the filters, contact your Lexus dealer.



NOTICE

■ When using the air conditioning system

Make sure that a filter is always installed.

Using the air conditioning system without a filter may cause damage to the system.

4-3. Do-it-yourself maintenance

Electronic key battery

Replace the battery with a new one if it is discharged.

■ You will need the following items:

- Flathead screwdriver
- Small Phillips-head screwdriver
- Lithium battery (CR1632)

■ Replacing the battery

STEP 1



CLY43AD123

Take out the mechanical key.

STEP 2



CLY43AD124

Remove the cover.

STEP 3



CLY43AD125

Remove the depleted battery.

Insert a new battery with the + terminal facing up.

■ If the electronic key battery is discharged

The following symptoms may occur:

- The smart entry & start system and wireless remote control will not function properly.
- The operational range is reduced.

■ Use a CR1632 lithium battery

- Batteries can be purchased at your Lexus dealer, jewelers, or camera stores.
- Replace only with the same or equivalent type recommended by the manufacturer.
- Dispose of used batteries according to the local laws.

■ When the card key battery needs to be replaced

The battery for the card key is available only at Lexus dealers. Your Lexus dealer can replace the battery for you.

CAUTION

■ Removed battery and other parts

Keep away from children.

These parts are small and if swallowed by a child, they can cause choking.

NOTICE

■ For normal operation after replacing the battery

Observe the following precautions to prevent accidents:

- Always work with dry hands.
Moisture may cause the battery to rust.
- Do not touch or move any other components inside the remote control.
- Do not bend either of the battery terminals.

4-3. Do-it-yourself maintenance

Checking and replacing fuses

If any of the electrical components do not operate, a fuse may have blown. If this happens, check and replace the fuses as necessary.

STEP 1 Turn the “ENGINE START STOP” switch OFF.

STEP 2 Remove the engine compartment cover. (→P. 453)

STEP 3 Open the fuse box cover.

► Engine compartment (type A fuse box)



Push the tabs in and lift the lid off.

► Engine compartment (type B fuse box)



Push the tab in and lift the lid off.

▶ Driver's side instrument panel



Remove the lid.

▶ Passenger's side instrument panel



Remove the lid.

▶ Trunk



Remove the lid.

STEP 4 After a system failure, see “Fuse layout and amperage ratings” for details about which fuse to check. (→P. 481)

STEP 5



Remove the fuse with the pull-out tool.

STEP 6 Check if the fuse has blown.

► Type A and B

Type A

1



2



1 Normal fuse

2 Blown fuse

Replace it with one of an appropriate amperage rating. The amperage rating can be found on the fuse box lid.

Type B

1



2



► Type C and D

Type C

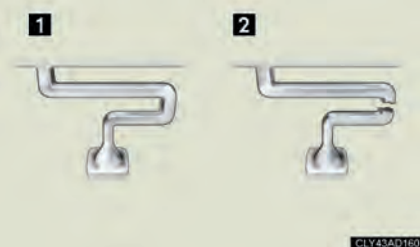

1 Normal fuse

2 Blown fuse

Contact your Lexus dealer.

Type D

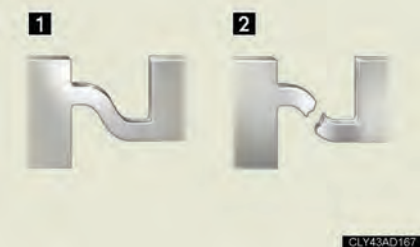

Fuse layout and amperage ratings

Engine compartment (type A fuse box)

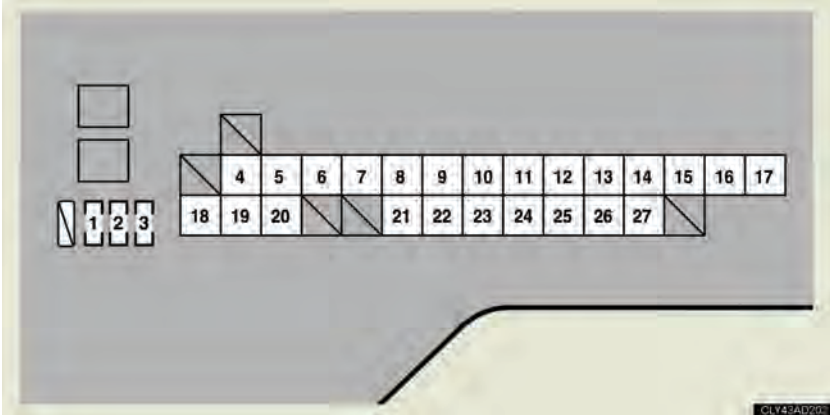

	Fuse	Ampere	Circuit
1	PTC HTR 3	25 A	PTC heater
2	PTC HTR 1	25 A	PTC heater
3	VSSR	5 A	Electric power control system
4	ALT	180 A	AIR SUS, HTR, DEFOG, FAN NO.1, H-LP CLN, PTC HTR 2, PTC HTR, RR A/C, E/G RM1, D-J/B ALT, P-J/B ALT, LUG-J/B ALT
5	P-J/B ALT	60 A	P P/SEAT 1, P P/SEAT 2, A/C, RR SEAT, P-IG1-1, P-IG1-2, P-IG1-3, P-IG1-4, P-ACC, P-CIG, AIR SUS, climate control seat system
6	FAN NO.1	80 A	Electric cooling fans
7	E/G RM1	80 A	DEICER, WIP, E/G RM-IG1-1, E/G RM-IG1-2, NV-IR, FR FOG, FR CTRL ALT, ABS MTR1

	Fuse	Ampere	Circuit
8	D-J/B ALT	80 A	OBD, D P/SEAT, TI&TE, AM1, S/ROOF, D-IG1-1, D-IG1-2, D-IG1-3, D-IG1-4, D-ACC, PWR OUTLET, PANEL, climate control seat system
9	PTC HTR	60 A	PTC HTR 1, PTC HTR 3
10	LUG-J/B ALT	50 A	PTL, RL SEAT, B/ANC, FUEL OPN, RR S/SHADE, PSB, RR-IG1-1, RR-IG1-2, RR-IG1-3, RR-ACC, RR-CIG
11	RR A/C	30 A	Air conditioning system
12	AIR SUS	40 A	—————
13	HTR	50 A	Air conditioning system
14	NOISE FILTER	40 A	Condenser
15	DEFOG	40 A	Rear window defogger
16	PTC HTR 2	50 A	PTC heater
17	H-LP CLN	30 A	Headlight cleaner
18	EPS	80 A	EPS
19	EFI	80 A	VVT, ETCS, ABS MAIN 1, EDU1, EDU2, A/F, ECU-IG, IGN, INJ, P-J/B
20	E/G RMB	80 A	D/C CUT 1, FR CTRL BAT, EPS ECU, ABS MAIN 2, ABS MTR2, ST, H-LP RL, H-LP LL
21	EFI NO.1	40 A	Multiport fuel injection system/ sequential multiport fuel injection system
22	E/G RMB2	30 A	ABS MAIN 3, EPS ECU, D/C CUT 2
23	D-J/B B	40 A	D-DOOR 1, HAZ, D-DOOR 2, STR LOCK, STOP, SECURITY

	Fuse	Ampere	Circuit
24	LUG J/B B	40 A	STOP LP 1, STOP LP 2, TAIL, E-PKB, capacitor
25	P-J/B B	40 A	P DOOR 1, P RR DOOR, AM2, RADIO NO.1, P-D/C CUT, P DOOR 2, PMG, AMP
26	VGRS	40 A	VGRS
27	BAT VB	30 A	VSSR

■ Engine compartment (type B fuse box)

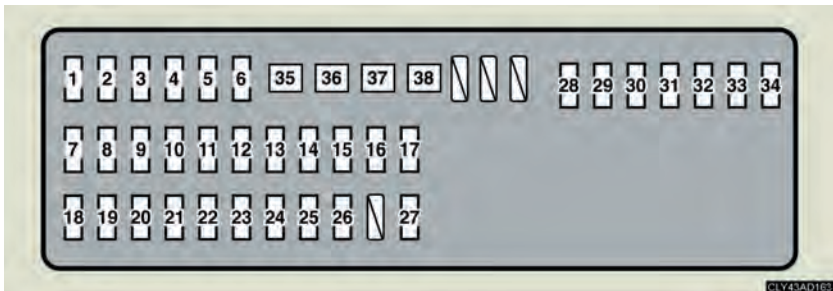

	Fuse	Ampere	Circuit
1	DEICER	25 A	Windshield wiper de-icer
2	WIP	30 A	Windshield wiper
3	ABS MAIN 2	10 A	ABS, VSC, VDIM
4	IGCT 1	25 A	Smart entry & start system
5	EPSECU	10 A	EPS
6	FR CTRL BAT	30 A	Headlight high beams, horns
7	E/G RM-IG1-2	10 A	AFS, headlight high beams, front position lights, horns, alarm, windshield washer, exhaust system, headlight cleaner

	Fuse	Ampere	Circuit
8	E/G RM-IG1-1	10 A	Charging system, EPS, electric cooling fans, AFS
9	H-LP LL	15 A	Headlight low beams
10	ABS MAIN 1	10 A	Brake system
11	H-LP RL	15 A	Headlight low beams
12	ETCS	10 A	Multiport fuel injection system/ sequential multiport fuel injection system
13	NV IR	10 A	Cruise control system
14	IGN	10 A	Multiport fuel injection system/ sequential multiport fuel injection system, brake system, airbag system
15	ECU-IG	10 A	Multiport fuel injection system/ sequential multiport fuel injection system, stop lights, charging system
16	D/C CUT1	30 A	ECU-B, D MPX-B 1, D MPX-B 2, P MPX-B, RR MPX-B 1, RR MPX-B 2, DOME
17	ECU-B	10 A	Headlight high beams, front position lights, horns, alarm, windshield washer, headlight cleaner
18	A/F	15 A	Multiport fuel injection system/ sequential multiport fuel injection system, exhaust system
19	EDU2	25 A	Multiport fuel injection system/ sequential multiport fuel injection system
20	FR CTRL ALT	20 A	Windshield washer, alarm, headlight cleaner, front position lights

	Fuse	Ampere	Circuit
21	EDU1	25 A	Multiport fuel injection system/ sequential multiport fuel injection system
22	RELIEF VLV	10 A	Fuel system
23	FR FOG	15 A	Front fog lights
24	A/C W/P	10 A	Air conditioning system, electric cooling fans
25	H-LP LVL	10 A	Discharge headlights, headlight high beams, front position lights, horns, alarm, windshield washer
26	P-J/B	10 A	P IG2, P RR-IG2
27	INJ	10 A	Multiport fuel injection system/ sequential multiport fuel injection system
28	D/C CUT 2	30 A	P MPX-B, RR ECU-B
29	ECU-B 2	5 A	Brake system
30	ABS MAIN 3	10 A	Brake system
31	EFI MAIN 2	25 A	Multiport fuel injection system/ sequential multiport fuel injection system, exhaust system
32	EFI MAIN	25 A	Multiport fuel injection system/ sequential multiport fuel injection system, fuel system
33	EFI	10 A	Multiport fuel injection system/ sequential multiport fuel injection system, fuel system
34	EFI-B	10 A	Multiport fuel injection system/ sequential multiport fuel injection system

	Fuse	Ampere	Circuit
35	ST	30 A	Starter system
36	ABS MTR1	50 A	Brake system
37	ABS MTR2	50 A	Brake system
38	VVT	40 A	Multiport fuel injection system/ sequential multiport fuel injection system

Driver's side instrument panel

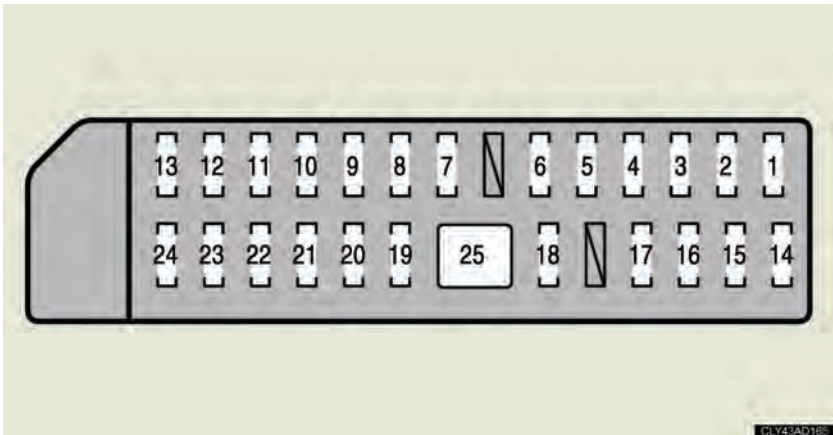

	Fuse	Ampere	Circuit
1	D-IG1-3	10 A	Automatic transmission, power door lock system, cruise control system, brake system, rear window defogger, moon roof, pre-crash seat belt, head restraints, power outlet, turn signal lights, climate control seat system, audio system
2	D-IG1-2	5 A	Cruise control system
3	D-IG1-4	15 A	Starter system, climate control seat system

	Fuse	Ampere	Circuit
4	D-IG1-1	5 A	Main body ECU, tilt and telescopic steering, starter system
5	PWR OUTLET	15 A	Power outlet
6	D-ACC	5 A	Power door lock system
7	S/ROOF	30 A	Moon roof
8	TI&TE	30 A	Tilt and telescopic steering
9	AM1	5 A	Power door lock system
10	OBD	10 A	On-board diagnosis system
11	D P/SEAT	30 A	Front seat adjustment
12	D S/HTR	20 A	Climate control seat system
13	D RR S/HTR	30 A	Climate control seat system
14	D MPX-B 1	10 A	Meters and gauges, front seat adjustment, rear seat adjustment, tilt and telescopic steering, power door lock system, cruise control system
15	DOME	10 A	Interior lights, clock
16	D MPX-B 2	10 A	Audio system
17	PANEL	10 A	Fuel filler door opener, interior lights, audio system
18	SECURITY	5 A	Smart entry & start system, theft deterrent system
19	STR LOCK	20 A	Tilt and telescopic steering
20	D DOOR 2	10 A	Power door lock system
21	HAZ	10 A	Turn signal lights
22	D RR DOOR	25 A	Interior lights, power door lock system, power windows

	Fuse	Ampere	Circuit
23	D DOOR1	25 A	Interior lights, outside rear view mirror, power door lock system, power windows, outside rear view mirror defogger
24	STOP	5 A	Stop lights
25	AMP	30 A	Audio system

Passenger's side instrument panel

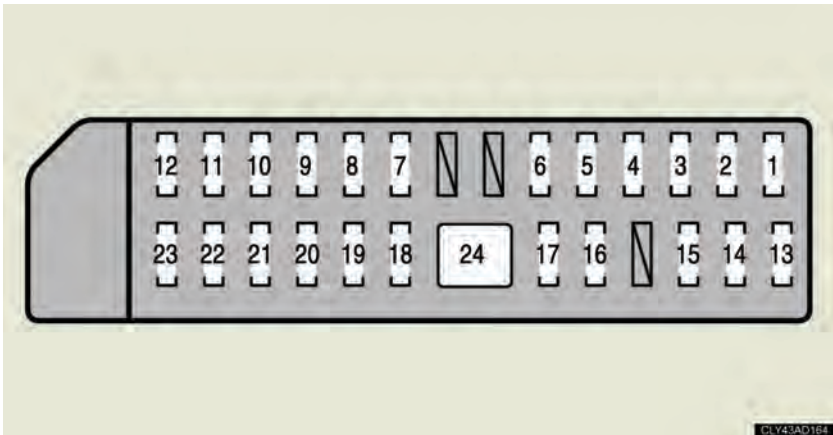

	Fuse	Ampere	Circuit
1	P-IG1-2	5 A	Audio system
2	P-IG1-3	5 A	VGRS
3	P-IG1-1	10 A	Audio system, power door lock system, VGRS, air conditioning system, head restraints, pre-crash seat belt, Lexus parking assist-sensor
4	P-IG1-4	10 A	Climate control seat system
5	P-CIG	15 A	Cigarette lighter

	Fuse	Ampere	Circuit
6	P-ACC	5 A	Audio system, clock, cruise control system
7	A/C	10 A	Air conditioning system
8	P S/HTR	20 A	Climate control seat system
9	P P/SEAT 2	30 A	Front seat adjustment
10	RR SEAT	30 A	Rear seat adjustment
11	P P/SEAT 1	30 A	Front seat adjustment
12	P RR S/HTR	30 A	Climate control seat system
13	P IG2	5 A	Tilt and telescopic steering, smart entry & start system, meters and gauges, electric power control system
14	P RR-IG2	5 A	On-board diagnosis system
15	P MPX-B	10 A	Power door lock system, front seat adjustment, rear seat adjustment, VGRS, smart entry & start system, starter system, Lexus parking assist-sensor
16	AIR SUS	20 A	—————
17	AM2	10 A	Power door lock system
18	RADIO NO.1	20 A	Air conditioning system
19	PMG	5 A	Electric power control system
20	P-D/C CUT	5 A	Headlight switch, windshield wiper and washer, horn, tilt and telescopic steering, power windows, power door lock system, door sunshade, rear sunshade, rear seat adjustment, steering wheel switches
21	P DOOR 2	10 A	Power door lock system

	Fuse	Ampere	Circuit
22	PRR DOOR	25 A	Interior lights, power door lock system, power windows
23	P DOOR1	25 A	Interior lights, outside rear view mirror, power door lock system, power windows, outside rear view mirror defogger
24	AMP	30 A	Audio system

Luggage compartment

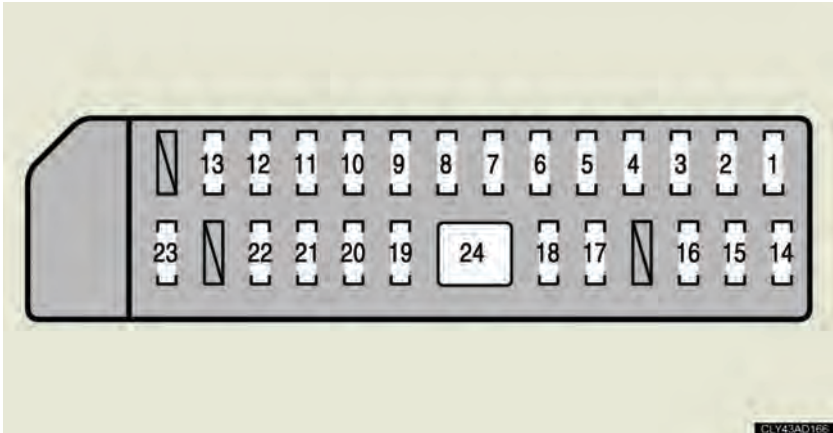

	Fuse	Ampere	Circuit
1	RR-IG1-3	10 A	Climate control seat system
2	RR-IG1-4	10 A	Rear seat adjustment
3	RR-IG1-2	10 A	Power door lock system, cool box, air conditioning system
4	RR-IG1-1	5 A	Capacitor, brake system, rear seat adjustment
5	RR-ACC	5 A	Audio system, rear seat entertainment system

	Fuse	Ampere	Circuit
6	RR-CIG	15 A	Cigarette lighter
7	AC100/115V	15 A	Power outlet
8	RL SEAT	30 A	Rear seat adjustment
9	B/ANC	10 A	Shoulder anchor
10	RR S/SHADE	10 A	Rear sunshade
11	PSB	30 A	_____
12	PTL	30 A	Power trunk lid
13	FUEL OPN	15 A	Fuel filler door opener, power trunk lid
14	RR MPX-B 1	10 A	Audio system, rear seat entertainment system, power trunk lid
15	RR MPX-B 2	5 A	Power door lock system, rear seat adjustment, interior lights, power trunk lid, alarm
16	IGCT 3	5 A	_____
17	BATT FAN	20 A	Electric cooling fan
18	B-FAN RLY	5 A	Electric cooling fan
19	RR ECU-B	5 A	Seat belt buckle lights, trunk light
20	ABS MAIN 4	10 A	Capacitor
21	STOP LP 1	10 A	Stop lights, back-up lights
22	STOP LP 2	10 A	Stop lights, rear fog lights, high-mounted stoplights
23	TAIL	5 A	Tail lights, license plate lights
24	E-PKB	30 A	Brake system

■ After a fuse is replaced

- If the lights do not turn on even after the fuse has been replaced, a bulb may need replacement. (→P. 493)
- If the replaced fuse blows again, have the vehicle inspected by your Lexus dealer.

■ If there is an overload in the circuit

The fuses are designed to blow before the entire wiring harness is damaged.

CAUTION

■ To prevent system breakdowns and vehicle fire

Observe the following precautions.

Failing to do so may cause damage, and possibly a fire or injury.

- Never use a fuse of a higher amperage rating than indicated, or use any other object in place of a fuse.
- Always use a genuine Lexus fuse or equivalent.
Never replace a fuse with a wire, even as a temporary fix.
This can cause extensive damage or even fire.
- Do not modify the fuse or the fuse box.

NOTICE

■ Before replacing fuses

Have the cause of electrical overload determined and repaired by your Lexus dealer.

4-3. Do-it-yourself maintenance

Light bulbs

You may replace the following bulbs by yourself. The difficulty level of replacement varies depending on the bulb. If necessary bulb replacement seems difficult to perform, contact your Lexus dealer.

For more information about replacing other light bulbs, contact your Lexus dealer.

■ Preparing for light bulb replacement

Check the wattage of the light bulb being replaced. (→P. 554)

■ Remove the engine compartment cover

→P. 453

■ Front bulb locations

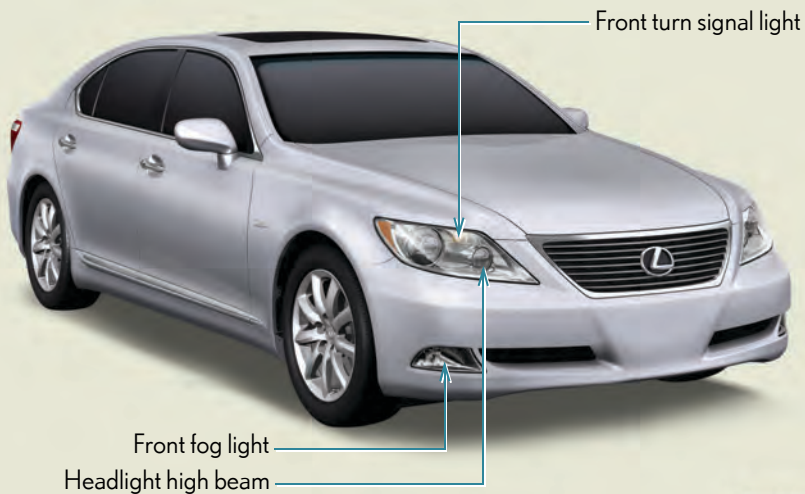

CLY43AD090

■ Rear bulb locations

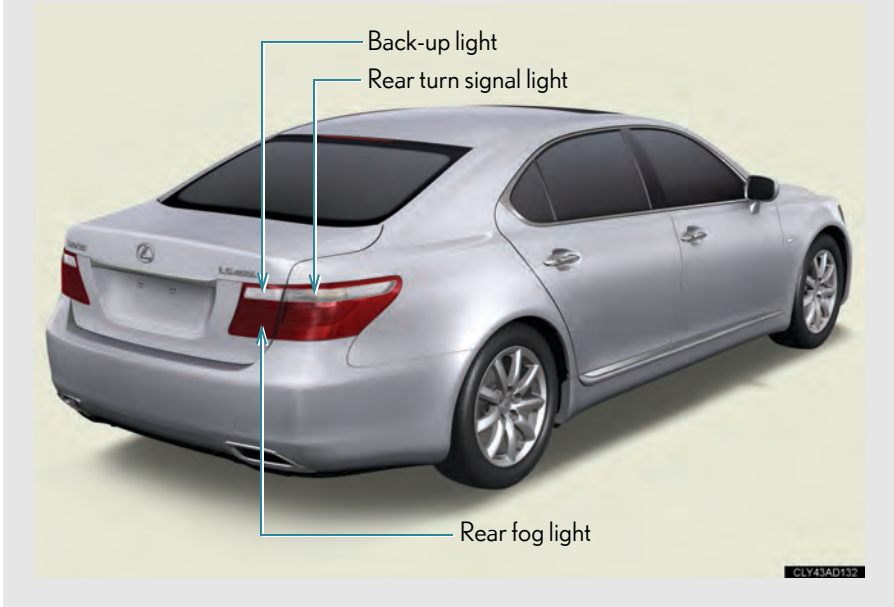

Replacing light bulbs

■ Headlight high beams

STEP 1 When replacing the bulbs:

► Left side



Remove the securing bolt and move the washer fluid filler opening.

► Right side



Remove the securing bolts and nut, and move the fuse block.

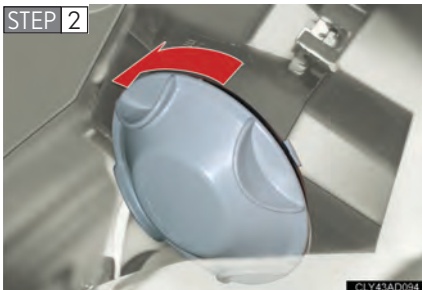

Turn the cover counterclockwise and remove it.

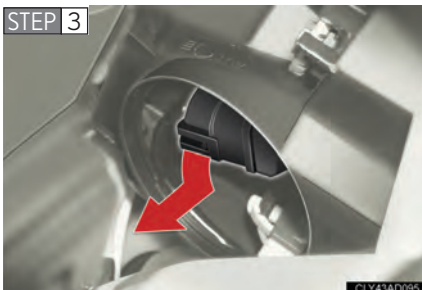

Turn the bulb base counterclockwise.



Unplug the connector while depressing the lock release.

■ Front fog lights

STEP 1



To allow enough working clearance, turn the steering wheel to the opposite side of the bulb to be replaced.

Remove the fender liner bolt and clips, and then remove the fender liner.

STEP 2

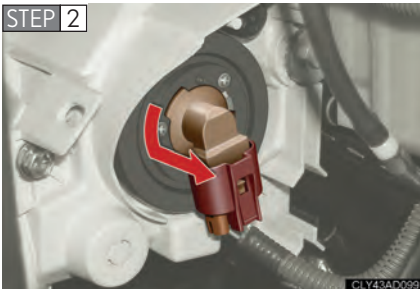

Turn the bulb base counterclockwise.

STEP 3

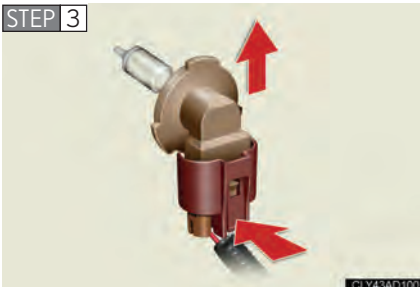

Unplug the connector while depressing the lock release.

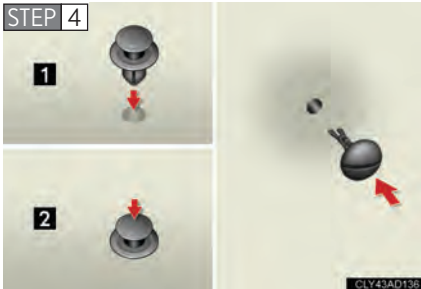

Install the bolt and clips.

■ Front turn signal lights

STEP 1 When replacing the bulbs:

► Left side



Remove the securing bolt and move the washer fluid filler opening.

► Right side



Remove the securing bolts and nut, and move the fuse block.

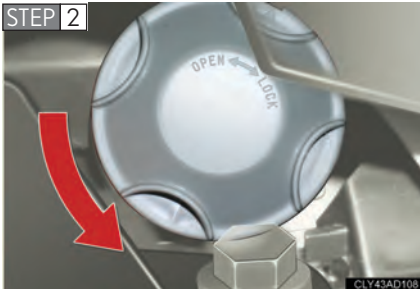

Turn the cover counterclockwise and remove it.

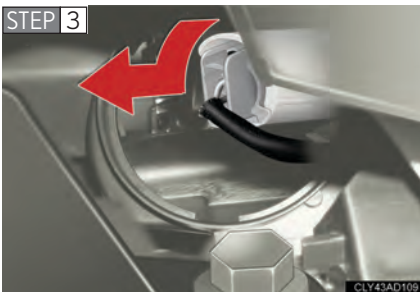

Turn the bulb base counterclockwise.



Remove the light bulb.

■ Back-up lights and rear fog lights

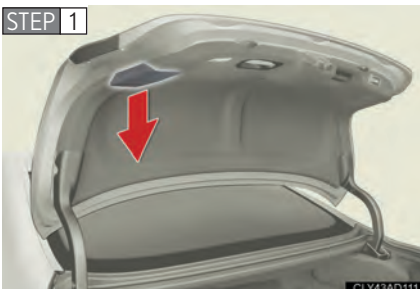

Open the trunk lid and remove the cover.

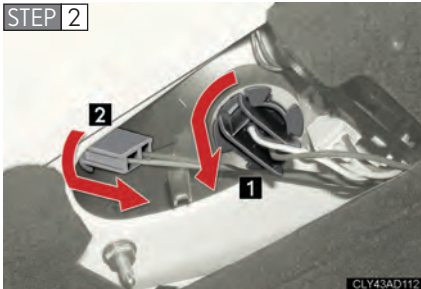

Turn the bulb bases counterclockwise.

- 1 Rear fog light (if equipped)
- 2 Back-up light

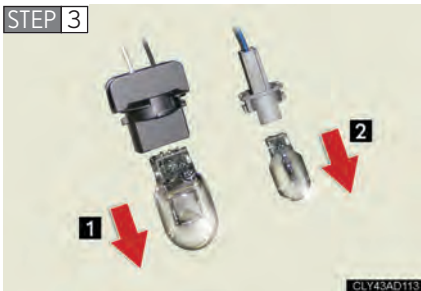

Remove the light bulb.

- 1 Rear fog light (if equipped)
- 2 Back-up light

■ Rear turn signal lights



Open the trunk lid and remove the cover.

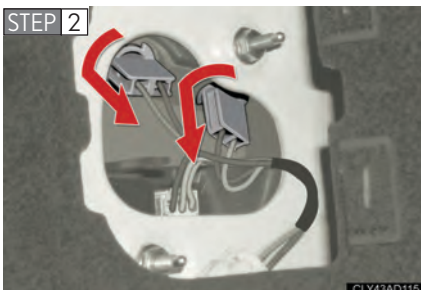

Turn the bulb bases counterclockwise.

STEP 3

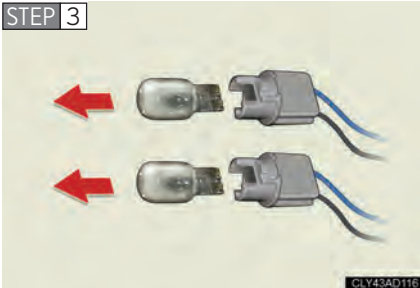

Remove the light bulbs.

■ Lights other than the above

If any of the lights listed below has burnt out, have it replaced by your Lexus.

- Headlight low beams
- Front position lights
- Side turn signal lights
- Stop/tail lights
- High mounted stoplight
- License plate lights

■ Condensation build-up on the inside of the lens

Contact your Lexus dealer for more information in the following situations. Temporary condensation build-up on the inside of the headlight lens does not indicate a malfunction.

- Large drops of water are built up on the inside of the lens.
- Water has built up inside the headlight.

■ Discharge headlights

If voltage to the discharge bulbs is insufficient, the bulbs may not come on, or may go out temporarily. The discharge bulbs will come on when normal power is restored.

■ LED stop/tail lights and high mounted stoplight

The stop/tail lights and high mounted stoplight consist of a number of LEDs. If any of the LEDs burn out, take your vehicle to your Lexus dealer to have the light replaced.

CAUTION

■ Replacing light bulbs

- Turn off the headlights. Do not attempt to replace the bulb immediately after turning off the headlights.
The bulbs become very hot and may cause burns.
- Do not touch the glass portion of the light bulb with bare hands. Hold the bulb by the plastic or metal portion.
If the bulb is scratched or dropped it may blow out or crack.
- Fully install light bulbs and any parts used to secure them. Failing to do so may result in heat damage, fire, or water entering the headlight unit. This may damage the headlights or cause condensation to build up on the lens.
- Do not attempt to take apart or repair the low beam discharge headlight bulbs, connectors, power supply circuits, or related components.
Doing so could result in electric shock and serious injury or death.

■ Discharge headlights

- Contact your Lexus dealer before replacing discharge headlights (including light bulbs).
- Do not touch the high-intensity discharge headlight's high voltage socket when the headlights are turned on.
An extremely high voltage of 20000 V will be discharged and could result in serious injury or death by electric shock.

■ To prevent damage or fire

Make sure bulbs are fully seated and locked.

5-1. Essential information 504

- If your vehicle needs to
be towed..... 504
- If you think something is
wrong 510
- Fuel pump shut off system..... 511

**5-2. Steps to take in an
emergency 512**

- If a warning light turns on
or a warning buzzer
sounds... 512
- If a warning message is
displayed 517
- If you have a flat tire 520
- If the engine will not start.... 528
- If the shift lever cannot be
shifted from P 530
- If the parking brake cannot
be released..... 531
- If you lose your keys 533
- If the electronic key does
not operate properly 534
- If the battery is
discharged..... 537
- If your vehicle overheats 541
- If the vehicle becomes
stuck 544

5-1. Essential information

If your vehicle needs to be towed

If towing is necessary, we recommend having your vehicle towed by your Lexus dealer or a commercial towing service, using a lift-type truck or a flatbed truck.

Use a safety chain system for all towing, and abide by all state/provincial and local laws.

If towing from the rear, the vehicle's front wheels and axles must be in good condition. (→P. 508)

If the vehicle is damaged, use a towing dolly or flatbed truck.

Before towing

The following may indicate a problem with your transmission. Contact your Lexus dealer before towing.

- The engine is running, but the vehicle will not move.
- The vehicle makes an abnormal sound.

Emergency towing

If a tow truck is not available, in an emergency your vehicle may be temporarily towed using a cable or chain secured to the emergency towing eyelet(s). This should only be attempted on hard, surfaced roads for short distances at low speeds.

A driver must be in the vehicle to steer and operate the brakes. The vehicle's wheels, drive train, axles, steering and brakes must be in good condition.



1 Towing eyelets

■ Before emergency towing

- Release the parking brake.
- Shift the shift lever to “N”.
- Turn the “ENGINE START STOP” switch to ACCESSORY (engine off) or IGNITION ON mode (engine running).

⚠ CAUTION**■ Caution while towing**

- Use extreme caution when towing the vehicle.
Avoid sudden starts or erratic driving maneuvers which place excessive stress on the emergency towing eyelets and the cables or chains.
- If the engine is not running, the power assist for the brakes and steering will not function, making steering and braking more difficult.

⚠ NOTICE**■ To prevent causing serious damage to the transmission**

Never tow this vehicle from the front with the rear wheels on the ground.
This may cause serious damage to the transmission.

Installing towing eyelets

STEP 1

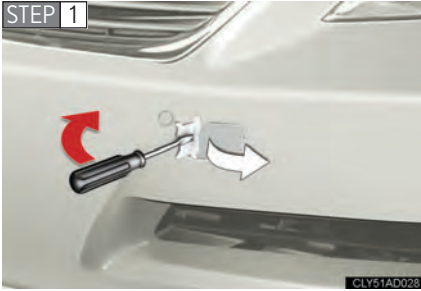

Remove the eyelet cover using a flat head screwdriver.

To protect the bodywork, place a rag between the screwdriver and the vehicle body, as shown in the illustration.

STEP 2

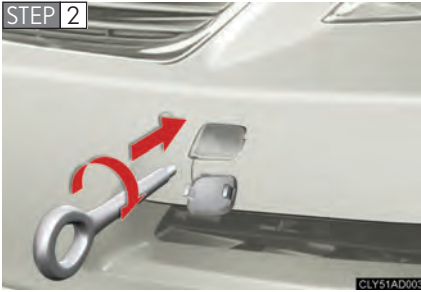

Insert the towing eyelet into the hole and tighten partially by hand.

STEP 3



Tighten down the towing eyelet securely using a wheel nut wrench.

■ Location of the emergency towing eyelet

→P. 520

⚠ CAUTION**■ Installing towing eyelets to the vehicle**

Make sure that towing eyelets are installed securely.

If not securely installed, towing eyelets may come loose during towing. This may lead to accidents that cause serious injury or even death.

Towing with a sling-type truck**⚠ NOTICE****■ To prevent body damage**

Do not tow with a sling-type truck, either from the front or rear.

Towing with a wheel lift-type truck

► From the front

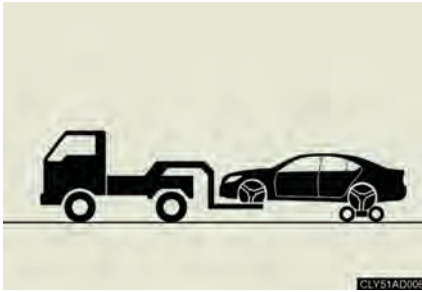

Use a towing dolly under the rear wheels.

► From the rear

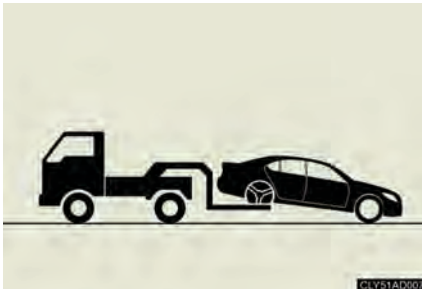

Switch to ACCESSORY mode so that the steering wheel is unlocked.

⚠ NOTICE

■ To prevent causing serious damage to the transmission

Never tow this vehicle from the front with the rear wheels on the ground.

■ To prevent damaging the vehicle

- Do not tow the vehicle with the “ENGINE START STOP” switch OFF. The steering lock mechanism is not strong enough to hold the front wheels straight.
- When raising the vehicle, ensure adequate ground clearance for towing at the opposite end of the raised vehicle. Without adequate clearance, the vehicle could be damaged while being towed.

Using a flat bed truck



If your Lexus is transported by a flat bed truck, it should be tied down at the locations shown in the illustration.

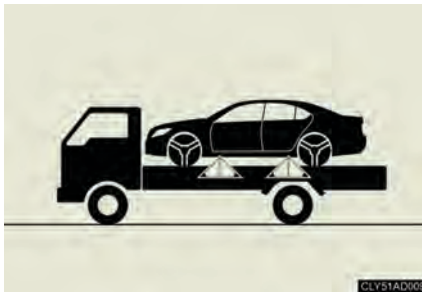

If you use chains or cables to tie down your vehicle, the angles shaded in black must be 45°.

Do not overly tighten the tie downs or the vehicle may be damaged.

If you think something is wrong

If you notice any of the following symptoms, your vehicle probably needs adjustment or repair. Contact your Lexus dealer as soon as possible.

■ Visible symptoms

- Fluid leaks under the vehicle.
(Water dripping from the air conditioning after use is normal.)
- Flat-looking tires or uneven tire wear
- Engine coolant temperature gauge needle continually points higher than normal.

■ Audible symptoms

- Changes in exhaust sound
- Excessive tire squeal when cornering
- Strange noises related to the suspension system
- Pinging or other noises related to the engine

■ Operational symptoms

- Engine missing, stumbling or running rough
- Appreciable loss of power
- Vehicle pulls heavily to one side when braking.
- Vehicle pulls heavily to one side when driving on a level road.
- Loss of brake effectiveness, spongy feeling, pedal almost touches the floor

Fuel pump shut off system

To minimize the risk of fuel leakage when the engine stalls or an airbag inflates upon collision, the fuel pump shut off system stops supplying fuel to the engine.

Follow the procedure below to restart the engine after the system is activated.

STEP 1 Switch to ACCESSORY mode or OFF.

STEP 2 Restart the engine.



NOTICE

■ Before starting the engine

Inspect the ground under the vehicle.

If you find that fuel has leaked on to the ground, the fuel system has been damaged and is in need of repair. Do not restart the engine.

5-2. Steps to take in an emergency

If a warning light turns on or a warning buzzer sounds...

Calmly perform the following actions if any of the warning lights turn on or flash. If a light turns on or flashes, but then turns off, this does not necessarily indicate a malfunction in the system.

Stop the vehicle immediately. Continuing to drive the vehicle may be dangerous.

The following warning indicates a possible problem in the brake system. Immediately stop the vehicle in a safe place and contact your Lexus dealer.

Warning light	Warning light/Details
	Brake system warning light (red indicator) <ul style="list-style-type: none">• Low brake fluid• Malfunction in the electronically controlled brake system





Stop the vehicle immediately.

The following warning indicates the possibility of damage to the vehicle that may lead to an accident. Immediately stop the vehicle in a safe place and contact your Lexus dealer.

Warning light	Warning light/Details
	Charging system warning light Indicates a malfunction in the vehicle's charging system

Have the vehicle inspected immediately.

Failing to investigate the cause of the following warnings may lead to the system operating abnormally and possibly cause an accident. Have the vehicle inspected by your Lexus dealer immediately.

Warning light	Warning light/Details
	<p>Malfunction indicator lamp</p> <p>Indicates a malfunction in:</p> <ul style="list-style-type: none"> • The electronic engine control system; • The electronic throttle control system; • The electronic automatic transmission control system
	<p>SRS warning light</p> <p>Indicates a malfunction in:</p> <ul style="list-style-type: none"> • The SRS airbag system; • The seat belt pretensioner system
	<p>ABS warning light</p> <p>Indicates a malfunction in:</p> <ul style="list-style-type: none"> • The ABS; • The brake assist system
	<p>Brake system warning light (yellow indicator)</p> <p>Indicates a malfunction in:</p> <ul style="list-style-type: none"> • The electronically controlled brake system; or • The electric parking brake
	<p>Electric power steering warning light</p> <ul style="list-style-type: none"> • Indicates a malfunction in the EPS (Electric Power Steering) system

■ Power steering warning light

When the battery is low or when the voltage drops temporarily, the power steering warning light may come on.

 **CAUTION**

■ **When the power steering warning light comes on**

The steering wheel may become extremely heavy.

If the steering wheel becomes heavier than usual when operating, firmly hold and operate it using more force than usual.

Follow the correction procedures.

After taking the specified steps to correct the suspected problem, check that the warning light turns off.

Warning light	Warning light/Details	Correction procedure
	Open door warning light (warning buzzer)*¹ Indicates that a door or the trunk is not fully closed.	Check that all doors and the trunk are closed.
 In the fuel gauge	Low fuel level warning light Remaining fuel (Approximately 13 L [3.4 gal., 2.8 Imp. gal.] or less)	Refuel the vehicle.
	Driver's seat belt reminder light (warning buzzer)*² Warns the driver to fasten his/her seat belt.	Fasten the seat belt.
	Front passenger's seat belt reminder light (warning buzzer)*² Warns the front passenger to fasten his or her seat belt.	Fasten the seat belt.
	Master warning light A buzzer sounds and the warning light comes on or flashes to indicate that the master warning system has detected a malfunction.	→P. 517

*1: Open door warning buzzer:

The open door warning buzzer sounds to alert one or more of the doors is not fully closed (with the vehicle having reached a speed of 5 km/h [3 mph]).

*2: Driver's and front passenger's seat belt reminders:

The driver's and front passenger's seat belt reminders sound to alert the driver and front passenger that his or her seat belt is not fastened. The buzzer sounds for 30 seconds after the vehicle has reached a speed of at least 20 km/h (12 mph). Then, if the seat belt is still unfastened, the buzzer will sound in a different tone for 90 more seconds.

■ Front passenger detection sensor and passenger seat belt reminder

- If luggage is placed on the front passenger seat, the front passenger detection sensor may cause the warning light to flash, even if a passenger is not sitting in the seat.
- If a cushion is placed on the seat, the sensor may not detect a passenger, and the warning light may not operate properly.

5-2. Steps to take in an emergency

If a warning message is displayed

The multi-information display shows warnings of system malfunctions, incorrectly performed operations, or shows messages that indicate a need for maintenance. When a message is shown, perform the correction procedure appropriate to the message.



1 Master warning light

The master warning light comes on or flashes when a message is being shown on the multi-information display.

2 Multi-information display

If any of the warning messages is shown again after its correction procedure has been performed, contact your Lexus dealer.

Messages and warnings

The warning lights and warning buzzers operate as follows depending on the content of the message. If a message indicates the need for inspection by a dealer, have the vehicle inspected by your Lexus dealer immediately.

	System warning light	Warning buzzer*	Warning
Comes on	—	Sounds	Indicates an important situation, such as when a system related to driving is malfunctioning or that danger may result if the correction procedure is not performed

	System warning light	Warning buzzer*	Warning
—	Comes on or flashes	Sounds	Indicates an important situation, such as when the system shown on the multi-information display may be malfunctioning
Flashes	—	Sounds	Indicates a situation, such as damage to the vehicle or danger may result
Comes on	—	Does not sound	Indicates a condition, such as malfunction of electrical components, their condition, or indicates the need for maintenance
Flashes	—	Does not sound	Indicates a situation, such as an operation has been performed incorrectly, or indicates how to perform an operation correctly

*A buzzer sounds the first time a message is shown on the multi-information display.

■ System warning lights

The master warning light does not come on or flash in the following cases. Instead, a separate system warning light will come on or flash along with the message shown on the multi-information display.

- Malfunction of the AFS (Adaptive Front Lighting System)
The AFS OFF indicator light flashes. (→P. 160)
- Malfunction of the brake system
The brake system warning light (red indicator) comes on. (→P. 512)
- Malfunction of the electronically controlled brake system or electric parking brake system
The brake system warning light (yellow indicator) comes on. (→P. 513)
- Malfunction of the ABS
The ABS warning light comes on. (→P. 513)
- Malfunction of the charging system
The charging system warning light comes on. (→P. 512)
- High engine coolant temperature
The needle of the engine coolant temperature gauge enters the red zone. (→P. 149)

■ When “Electrical equipment operation is limited” is shown

This message indicates that the battery is low. When the message is shown, operation of electrical equipment that uses a large amount of electric power, such as the air conditioning system, may be limited temporarily. This does not indicate a malfunction. Operation of electrical equipment will be restored after the battery is charged.

5-2. Steps to take in an emergency If you have a flat tire

Remove the flat tire and replace it with the spare provided.

■ Before jacking up the vehicle

- Stop the vehicle on a hard, flat surface.
- Set the parking brake.
- Shift the shift lever to P.
- Stop the engine.
- Turn on the emergency flashers.

■ Location of the spare tire, jack and tools

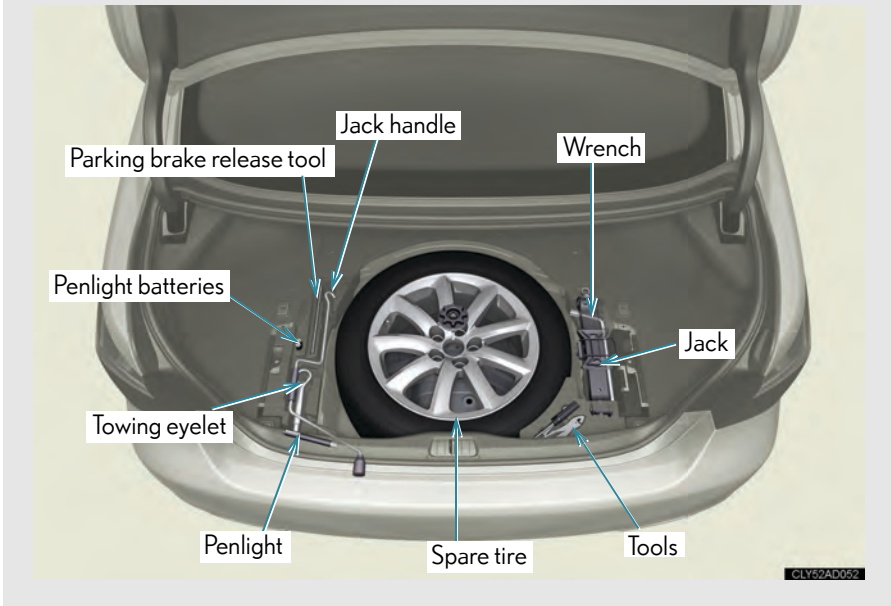

Penlight

The vehicle is equipped with a penlight, located inside the trunk. The penlight is provided in case it is necessary to perform an unexpected service operation at night, such as installation of the spare tire.



- 1 Turn the top portion to remove it.
- 2 Insert batteries.
- 3 Install the top portion.
- 4 On/Off

Taking out the jack and spare tire



Lift up the hook of the panel on the trunk floor.



Secure the panel using the hook provided.

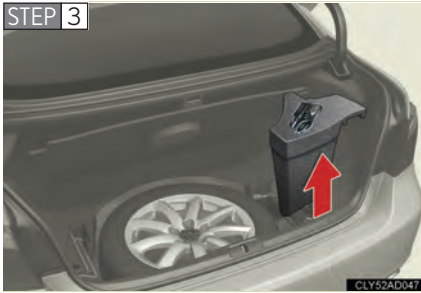

Remove the tool tray.

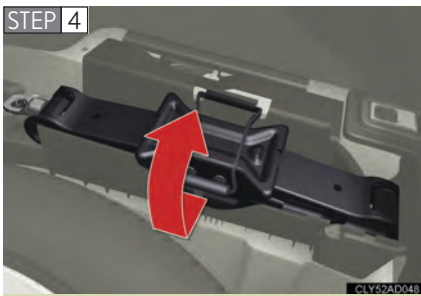

Remove the jack after removing the hook.

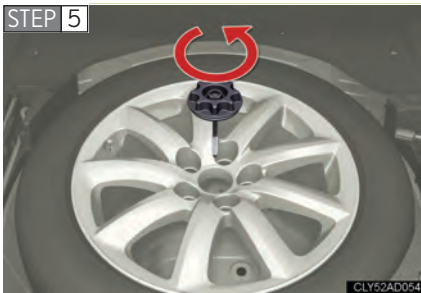

Loosen the center fastener that secures the spare tire.

If the center fastener cannot be turned by hand, use the wrench that is stored in the trunk. (To secure the tire, tighten the center fastener by hand. Do not use the wrench or other tools.)

Replacing a flat tire

STEP 1



Chock the tires.

Flat tire		Wheel chock positions
Front	Left-hand side	Behind the rear right-hand side tire
	Right-hand side	Behind the rear left-hand side tire
Rear	Left-hand side	In front of the front right-hand side tire
	Right-hand side	In front of the front left-hand side tire

STEP 2



Slightly loosen the wheel nuts (one turn).

STEP 3

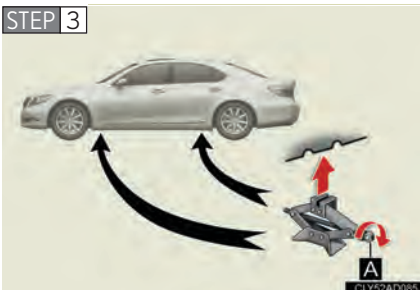

Turn the tire jack portion "A" by hand until the notch of the jack is in contact with the jack point.



Raise the vehicle until the tire is slightly raised off the ground.



Remove all the wheel nuts and the tire.

When resting the tire on the ground, place the tire so that the wheel design faces up to avoid scratching the wheel surface.

Installing the spare tire

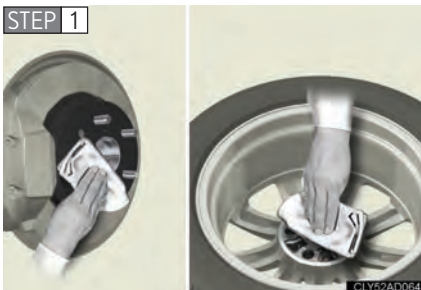

Remove any dirt or foreign matter from the wheel contact surface.

If foreign matter is on the wheel contact surface, the wheel nuts may loosen while the vehicle is in motion, and the tire may come off the vehicle.

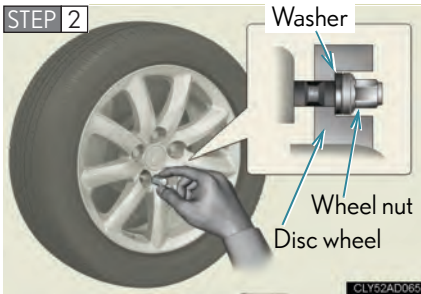

Install the spare tire and loosely tighten each wheel nut by hand to approximately the same amount.

Turn the lug nuts until the washers come into contact with the wheel.



Lower the vehicle.

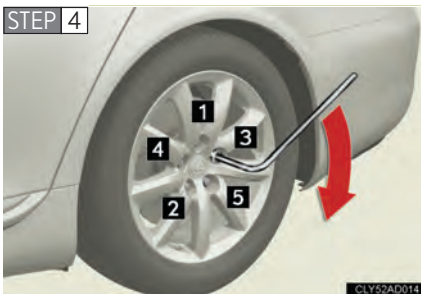

Firmly tighten each nut two or three times in the order shown in the illustration.

Tightening torque:
 $140 \text{ N}\cdot\text{m}$ (14.3 kgf $\cdot\text{m}$, 103.3 ft $\cdot\text{lb}$ f)

STEP 5 Stow the flat tire, tire jack and all tools.

 **CAUTION**

■ **Using the tire jack**

Improper use of the tire jack may lead to death or injuries due to the vehicle suddenly falling off the jack.

- Do not use the tire jack for any purpose other than replacing tires or installing and removing tire chains.
- Only use the tire jack that comes with this vehicle for replacing a flat tire. Do not use it on other vehicles, and do not use other tire jacks for replacing tires on this vehicle.
- Always check that the tire jack is securely set to the jack point.
- Do not put any part of your body under the vehicle supported by a jack.
- Do not start or run the engine while your vehicle is supported by the jack.
- Do not raise the vehicle while someone is in it.
- When raising the vehicle, do not put an object on or under the jack.
- Do not raise the vehicle to a height greater than that required to replace the tire.
- Use a jack stand if it is necessary to get under the vehicle.

Take particular care when lowering the vehicle to ensure that no one working on or near the vehicle may be injured.

■ **Replacing a flat tire**

Observe the following precautions to reduce the risk of death or serious injury:

- Never use oil or grease on the wheel bolts or wheel nuts. The oil or grease can cause the wheel nuts to loosen, causing a serious accident. Remove any oil or grease on the wheel bolts or wheel nuts.
- Have the wheel nuts tightened with a torque wrench to 140 N•m (14.3 kgf•m, 103.3 ft•lbf) as soon as possible after changing wheels. Failure to follow these precautions could cause the nuts to loosen and the wheel may fall off, which could lead to an accident causing death or serious injury.

 NOTICE**■ Do not drive the vehicle with a flat tire.**

Do not continue driving with a flat tire.

Driving even a short distance with a flat tire can damage the tire and the wheel beyond repair.

If the engine will not start

If the engine will not start even though correct starting procedures are being followed (→P. 135), consider each of the following points.

■ **The engine will not start, even when the starter motor operates normally.**

One of the following may be the cause of the problem:

- There may not be sufficient fuel in the vehicle's tank.
Refuel the vehicle.
- The engine may be flooded.
Try to restart the engine once more following correct starting procedures. (→P. 135)
- There may be a malfunction in the engine immobilizer system.
(→P. 97)

■ **The starter motor turns over slowly, the interior lights and headlights are dim, or the horn does not sound or sounds at a low volume.**

One of the following may be the cause of the problem:

- The battery may be discharged. (→P. 537)
- The battery terminal connections may be loose or corroded.

■ **The starter motor does not turn over.**

The following may be the cause of the problem:

- The engine starting system may be malfunctioning due to an electrical problem such as an open circuit or a blown fuse. However, an interim measure is available to start the engine. (→P. 529)

■ **The starter motor does not turn over, the interior lights and headlights do not turn on, or the horn does not sound.**

One of the following may be the cause of the problem:

- One or both of the battery terminals may be disconnected.
- The battery may be discharged. (→P. 537)
- There may be a malfunction in the steering lock system.

Contact your Lexus dealer if the problem cannot be repaired, or if repair procedures are unknown.

Emergency start function

When the engine does not start, the following steps can be used as an interim measure to start the engine if the “ENGINE START STOP” switch is functioning normally:

STEP 1 Set the parking brake.

STEP 2 Put the shift lever in P.

STEP 3 Set the “ENGINE START STOP” switch to ACCESSORY mode.

STEP 4 Press and hold the “ENGINE START STOP” switch about 15 seconds while depressing the brake pedal firmly.

Even if the engine can be started using the above steps, the system may be malfunctioning. Have the vehicle checked by your Lexus dealer.

5-2. Steps to take in an emergency

If the shift lever cannot be shifted from P

If the shift lever cannot be shifted with your foot on the brake pedal, there may be a problem with the shift lock system (a system to prevent accidental operation of the shift lever). Have the vehicle inspected by your Lexus dealer immediately.

The following steps may be used as an emergency measure to ensure that the shift lever can be shifted:

STEP 1 Set the parking brake.

STEP 2 Start the engine.

STEP 3 Depress the brake pedal.

STEP 4

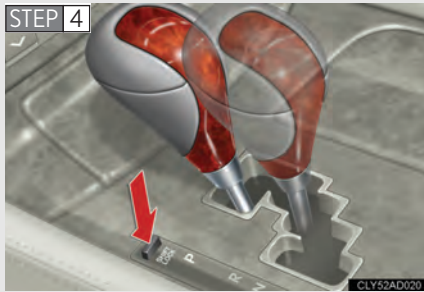

Press the shift lock override button.

The shift lever can be shifted while the button is pressed.

5-2. Steps to take in an emergency

If the parking brake cannot be released

In the event that the battery is discharged or switch operation does not release the parking brake, the parking brake can be released manually using the procedure below. This procedure should be performed only if necessary, such as in an emergency.

If the switch cannot be operated even when the battery is normal, the parking brake system may be malfunctioning. Have the vehicle inspected by your Lexus dealer immediately.

■ Before releasing the parking brake manually

- Shift the shift lever to P.
- Turn the “ENGINE START STOP” switch OFF.
- Check that the parking brake indicator is off.
- Chock the tires.

Releasing the parking brake manually

STEP 1

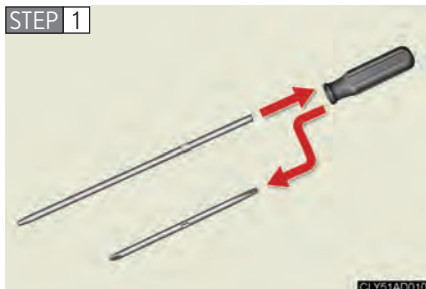

Take out the parking brake release tool and the screwdriver from the trunk.

Install the parking brake release tool into the screwdriver handle.

STEP 2 Take out the spare tire. (→P. 520)

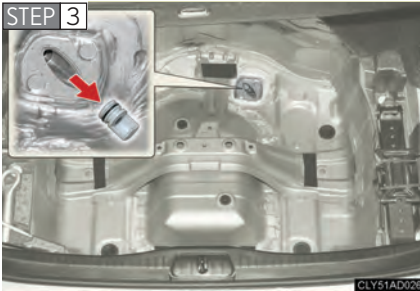

Remove the plug.

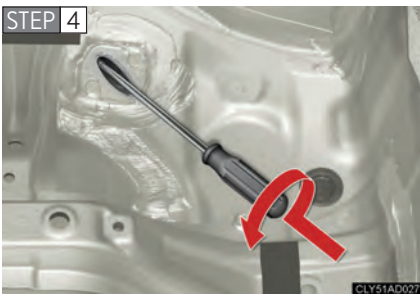

Insert the tool and press it down firmly while turning it counter-clockwise until it stops.

■ Manual operation of the parking brake

The parking brake cannot be set manually.

⚠ CAUTION

■ When releasing the parking brake manually

- Shift the shift lever to P, turn the "ENGINE START STOP" switch OFF and chock the tires.
Failure to do so may cause the vehicle to move, resulting in an accident.
- Turn the "ENGINE START STOP" switch OFF and check that the parking brake indicator is off.
Failure to do so may cause the system to operate and turn the parking brake release tool that is inserted, resulting in an injury.

5-2. Steps to take in an emergency

If you lose your keys

New genuine Lexus keys can be made by your Lexus dealer using one of the other keys and the key number stamped on your key number plate.

5-2. Steps to take in an emergency

If the electronic key does not operate properly

If communication between the electronic key and vehicle is interrupted (→P. 37) or the electronic key cannot be used because the battery is depleted, the smart entry & start system and wireless remote control cannot be used. In such cases, the doors and trunk can be opened or the engine can be started by following the procedure below.

Locking and unlocking the doors, unlocking the trunk and key linked functions

► Doors

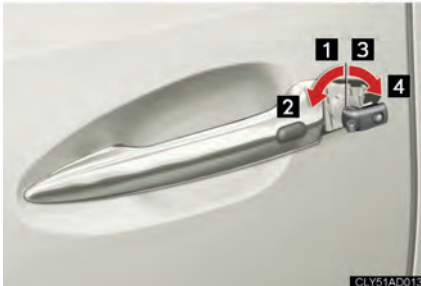

Remove the cover on the driver's door handle using the mechanical key in order to perform the following operations.

- 1 Locks all doors
- 2 Closes the windows (turn and hold)

The moon roof will also close. (if equipped)

- 3 Unlocks all doors
- 4 Opens the windows (turn and hold)

The moon roof will also open. (if equipped)

Return the cover to the original position after use.

► Trunk



Turn the mechanical key clockwise to open.

Changing “ENGINE START STOP” switch modes and starting the engine

STEP 1 Put the shift lever in P and apply the brakes.



Touch the Lexus emblem side of the electronic key to the “ENGINE START STOP” switch.

If any the doors is opened or closed after the key was touched to the switch to start the vehicle, an alarm will sound to indicate that the start function cannot detect the key.



STEP 3 To change “ENGINE START STOP” switch modes: Within 10 seconds of the buzzer sounding, release the brake pedal and press the “ENGINE START STOP” switch. Modes can be changed each time the switch is pressed.

(→P.135)

To start the engine: Press the “ENGINE START STOP” switch within 10 seconds after the buzzer sounds, keeping the brake pedal depressed.

In the event that the engine still cannot be started, contact your Lexus dealer.

■ **Stopping the engine**

Shift the shift lever to “P” and press the “ENGINE START STOP” switch as you normally do when stopping the engine.

■ **Replacing the key battery**

As the above procedure is a temporary measure, it is recommended that the electronic key battery be replaced immediately when the battery is depleted. (→P.475)

5-2. Steps to take in an emergency

If the battery is discharged

The following procedures may be used to start the engine if the vehicle's battery is discharged.

You can call your Lexus dealer, Roadside Assistance or Lexus Customer Service Assistance.

If you have a set of jumper (or booster) cables and a second vehicle with a 12-volt battery, you can jump start your Lexus following the steps below.

STEP 1 Remove the engine compartment covers and battery cover. (→P. 453)

STEP 2 Connect the jumper cables.

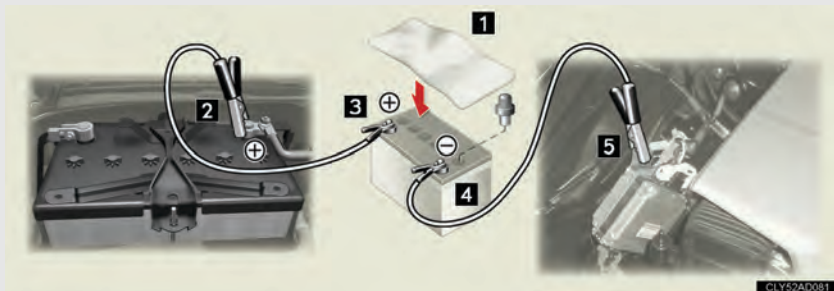

- 1** If required, remove all vent plugs from the booster battery. Lay a cloth over the open vents on the booster battery. (This helps reduce explosion hazard, personal injuries and burns.)
- 2** Positive (+) battery terminal on your vehicle
- 3** Positive (+) battery terminal on the second vehicle
- 4** Negative (-) battery terminal on the second vehicle
- 5** Connect the jumper cable to ground on your vehicle as shown in the illustration.

STEP 3 Start the engine of the second vehicle. Increase the engine speed slightly and maintain that level for approximately 5 minutes to recharge the battery of your vehicle.

STEP 4 Open and close any of the doors with the “ENGINE START STOP” switch OFF.

STEP 5 Maintain the engine speed of the second vehicle and turn the ignition switch to IGNITION ON mode, then start the engine.

STEP 6 Once the engine has started, remove the jumper cables in the exact reverse order in which they were connected.

Once the engine starts, have the vehicle inspected at your Lexus dealer as soon as possible.

■ Avoiding a discharged battery

- Turn off the headlights and the audio system while the engine is turned off.
- Turn off any unnecessary electrical components when the vehicle is running at a low speed for an extended period, such as in heavy traffic.

 **CAUTION****■ Avoiding battery fires or explosions**

Observe the following precautions to prevent accidentally igniting the flammable gas that may be emitted from the battery:

- Make sure the jumper cable is connected to the correct terminal and that it is not unintentionally in contact with any part other than the intended terminal.
- Do not allow the jumper cables to come into contact with the “+” and “-” terminals.
- Do not allow open flame or use matches, cigarette lighters or smoke near the battery.

■ Battery precautions

The battery contains poisonous and corrosive acidic electrolyte, while related parts contain lead and lead compounds. Observe the following precautions when handling the battery:

- When working with the battery, always wear safety glasses and take care not to allow any battery fluids (acid) to come into contact with skin, clothing or the vehicle body.
- Do not lean over the battery.
- In the event that battery fluid comes into contact with the skin or eyes, immediately wash the affected area with water and seek medical attention. Place a wet sponge or cloth over the affected area until medical attention can be received.
- Always wash your hands after handling the battery support, terminals, and other battery-related parts.
- Do not allow children near the battery.



NOTICE

■ **To prevent damaging the vehicle**

Do not pull- or push-start the vehicle, because the three-way catalytic converter may overheat and cause a fire hazard.

■ **When handling jumper cables**

Be careful that the jumper cables do not become tangled in the cooling fan or belt when connecting or disconnecting the cables.

5-2. Steps to take in an emergency If your vehicle overheats

If your engine overheats:

STEP 1 Stop the vehicle in a safe place and turn off the air conditioning system.

STEP 2 Check to see if steam is coming out from the engine area.

If you see steam:

Stop the engine and carefully lift the hood.

If you do not see steam:

Leave the engine running and carefully lift the hood.

STEP 3 Remove the engine compartment cover. (→P. 453)

STEP 4 Check if the cooling fan is operating.

If the fans are operating:

Wait until the temperature of the engine (shown on the instrument cluster) begins to fall and then stop the engine.

If the fans are not operating:

Stop the engine and call your Lexus dealer.

STEP 5

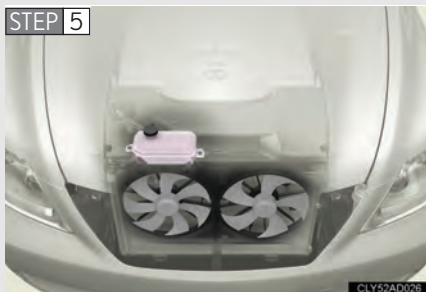

After the engine has cooled down, check the engine coolant level and inspect the cooling system for leaks.

STEP 6



Add engine coolant if necessary.

Water can be used in an emergency if engine coolant is unavailable. (→P. 550)

Have the vehicle inspected at the your nearest Lexus dealer as soon as possible.

■ Overheating

The following symptoms may occur when your vehicle is overheating:

- The engine coolant temperature gauge enters the red zone or a loss of power is experienced.
- Steam is coming from the engine area.

 **CAUTION****■ To prevent an accident or injury when inspecting under the hood of your vehicle**

- Keep hands and clothing away from the fan and other belts while the engine is running.
- Do not loosen the coolant reservoir cap while the engine and radiator are hot. Serious injury, such as burns, may result from hot coolant and steam released under pressure.

 **NOTICE****■ When adding engine coolant**

Wait until the engine has cooled down before adding engine coolant.

When adding coolant, do so slowly. Adding cool coolant to a hot engine too quickly can cause damage to the engine.

5-2. Steps to take in an emergency

If the vehicle becomes stuck

Carry out the following procedures if the tires spin or the vehicle becomes stuck in mud, dirt, or snow:

STEP 1 Stop the engine. Set the parking brake and put the selector lever in P.

STEP 2 Remove the mud, snow, or sand from around the stuck tire.

STEP 3 Place wood, stones or some other material to help provide traction under the tires.

STEP 4 Restart the engine.

STEP 5 Shift the shift lever to the D or R position and carefully apply the accelerator to free the vehicle.

Turn off TRC/VSC if these functions are hampering your attempts to free the vehicle. (→ P.184)

CAUTION

■ When attempting to free a stuck vehicle

If you choose to rock the vehicle back and forth to free it, make sure the surrounding area is clear to avoid striking other vehicles, objects or persons. The vehicle may also lunge forward or lunge back suddenly as it becomes free. Use extreme caution.

■ When shifting the shift lever

Be careful not to shift the shift lever with the accelerator pedal depressed. This may lead to unexpected rapid acceleration of the vehicle that may cause an accident and result in death or serious injury.

NOTICE

■ To avoid damaging the transmission and other components

- Avoid spinning the wheels and do not rev the engine.
- If the vehicle remains stuck after trying these procedures, the vehicle may require towing to be freed.

6-1. Specifications	546
Maintenance data (fuel, oil level, etc.).....	546
Fuel information	555
6-2. Customization	556
Customizable features.....	556

6-1. Specifications

Maintenance data (fuel, oil level, etc.)

Dimensions

Overall length		5150 mm (202.8 in.)
Over width		1875 mm (73.8 in.)
Overall height*		1475 mm (58.1 in.)
Wheelbase		3090 mm (121.7 in.)
Tread	Front	1615 mm (63.6 in.)
	Rear	1620 mm (63.8 in.)

*: Unladen vehicles

Vehicle identification

■ Vehicle identification

The vehicle identification number (VIN) is the legal identifier for your vehicle. This is the primary identification number for your Lexus. It is used in registering the ownership of your vehicle.



This number is stamped on the top left of the instrument panel and in the engine compartment.



This number is also on the manufacturer's label.

■ Engine number



The engine number is stamped on the engine block as shown.

Engine

Model	1UR-FE
Type	8 cylinder V type, 4 cycle, gasoline
Bore and stroke	94.0 × 83.0 mm (3.70 × 3.27 in.)
Displacement	4608 cm ³ (281.2 cu.in.)
Drive belt tension	Automatic adjustment

Fuel

Fuel type	Unleaded gasoline only
Research octane number	95 or higher
Fuel tank capacity	84 L (22.1 gal., 18.4 Imp.gal.)

Lubrication system

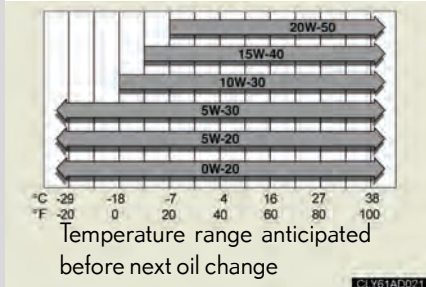
<p>Oil capacity (drain and refill) with filter without filter</p>	<p>8.6 L (9.1 qt., 7.6 Imp.qt.) 8.4 L (8.9 qt., 7.4 Imp.qt.)</p>
<p>Oil grade</p>	<p>20W-50 and 15W-40: API grade SL or SM multigrade engine oil 10W-30, 5W-30, 5W-20 and 0W-20: API grade SL “Energy-Conserving”, SM “Energy-Conserving” or ILSAC multigrade engine oil</p>
<p>Recommended oil viscosity</p>	<p>Use Lexus approved “Toyota Genuine Motor Oil” or equivalent to satisfy the grade and viscosity shown below.</p>  <p>Temperature range anticipated before next oil change</p> <p>CLY61AD001</p>

Oil viscosity

- The 0W portion of the oil viscosity rating indicates the characteristic of the oil which allows cold startability. Oils with a lower value before the W allow for easier starting of the engine in cold weather.
- The 20 in 0W-20 indicates the oil viscosity when the oil is at its operating temperature. An oil with a higher viscosity may be better suited if the vehicle is operated at high speeds, or under extreme load condition.

Cooling system

Capacity	11.8 L (12.5 qt., 10.4 Imp.qt.)
Coolant type	<p>Use either of the following.</p> <ul style="list-style-type: none"> • “Toyota Super Long Life Coolant” • Similar high-quality ethylene glycol-based non-silicate, non-amine, non-nitrite, and non-borate coolant with long-life hybrid organic acid technology <p>Do not use plain water alone.</p>

Ignition system

Spark plug	DENSO SK20HR11
Make	
Gap	

NOTICE

■ Iridium-tipped spark plugs

Use only iridium-tipped spark plugs. Do not adjust spark plug gap.

Electrical system

Battery	
Open voltage* at 20°C (68°F):	12.6 — 12.8 V Fully charged 12.2 — 12.4 V Half charged 11.8 — 12.0 V Discharged (*: Voltage checked 20 minutes after the engine and all the lights are turned off)
Charging rates	
Quick charge	15 A max.
Slow charge	5 A max.

Differential

Oil capacity	1.35 L (1.42 qt., 1.19 Imp.qt.)
Oil type and viscosity*	Toyota Genuine Differential gear oil LT 75W-85 GL-5 or equivalent

*: “Toyota Genuine Differential Gear Oil LT” is filled in your Lexus vehicle at factory fill. Use Lexus approved “Toyota Genuine Differential Gear Oil LT” or equivalent of matching quality to satisfy the above specification. Please contact your Lexus dealer for further details.

Automatic Transmission

Fluid capacity*	10.05 L (10.62 qt., 8.84 Imp.qt.)
Fluid type	Toyota Genuine ATF WS

*: The fluid capacity is a reference quantity. If replacement is necessary, contact your Lexus dealer.

 NOTICE**Automatic transmission fluid type**

Using automatic transmission fluid other than “Toyota Genuine ATF WS” may cause deterioration in shift quality, locking up of your transmission accompanied by vibration, and ultimately damage the automatic transmission of your vehicle.

Brakes

Pedal clearance *	95.0 mm (3.7 in.) Min.
Pedal free play	1.0 — 2.0 mm (0.04 — 0.08 in.)
Fluid type	SAE J1703 or FMVSS No. 116 DOT 3

*: Minimum pedal clearance when depressed with a force of 200 N (20 kgf, 50 lbf).

Steering

Free play	Less than 30 mm (1.2 in.)
-----------	---------------------------

Tires and wheels

Tire size	235/50R18 97W		
Tire inflation pressure (Recommended cold tire inflation pressure)	Vehicle speed	Front wheel kPa (kgf/cm ² or bar, psi)	Rear wheel kPa (kgf/cm ² or bar, psi)
	More than 210 km/h (132 mph)	300 (3.0, 44)	330 (3.3, 48) ^{*1} 320 (3.2, 46) ^{*2}
	From 160 km/h (100 mph) to 210km/h (132 mph)	250 (2.5, 36)	280 (2.8, 41) ^{*1} 260 (2.6, 38) ^{*2}
	160 km/h (100 mph) or less	230 (2.3, 33)	230 (2.3, 33)
Wheel size	18 × 7 1/2 J		
Wheel nut torque	140 N•m (14.3 kgf•m, 103.3 ft•lbf)		

*1: For all loads including full rated loads

*2: For reduced loads (1 to 4 passengers only)

Light bulbs

	Light Bulbs	W	Type
Exterior	Headlights High beam (halogen bulbs)	65	A
	Low/high beam (discharge bulbs)	35	B
	Front turn signal lights	21	C
	Front position lights	5	D
	Front fog lights	51	E
	Side turn signal lights	5	C
	Trunk lid light	3.8	D
	Trunk light	3.8	D
	Rear turn signal lights	16	D
	Back-up lights	16	D
	Rear fog lights	21	D
	Outer foot lights	5	D
Interior	Vanity lights Front	8	D
	Rear	3	F
	Interior lights Front	8	D
	Rear	8	F
	Door courtesy lights	5	D

A: HIR1 halogen bulbs

C: Wedge base bulbs (amber)

E: HB4 halogen bulbs

B: D4S discharge bulbs

D: Wedge base bulbs (clear)

F: Double end bulbs

6-1. Specifications

Fuel information

Your vehicle must use only unleaded gasoline.
For optimum engine performance, select premium unleaded gasoline with a Research Octane Number of 95 or higher.

■ Fuel tank opening for unleaded gasoline

To help prevent incorrect fueling, your Lexus has a fuel tank opening that only accommodates the special nozzle on unleaded fuel pumps.

■ If premium gasoline is not available

If this premium type cannot be obtained, you can use unleaded gasoline with a Research Octane Number as low as 91.

The use of such gasoline may cause the engine to knock or drastically reduce output to protect itself while driving with a heavy load. To avoid this, refill the tank with premium unleaded gasoline as soon as possible.

■ If your engine knocks

- Consult your Lexus dealer.
- You may occasionally notice light knocking for a short time while accelerating or driving uphill. This is normal and there is no need for concern.

NOTICE

■ Notice on gasoline quality

Do not use leaded gasoline.
Leaded gasoline will cause the three-way catalytic converter to lose its effectiveness and emission control system to function improperly.

Customizable features

Your vehicle includes a variety of electronic features that can be personalized to your preferences. Programming these preferences requires specialized equipment and may be performed by your Lexus dealer.

Some function settings are changed simultaneously with other functions being customized. Contact your Lexus dealer for further details.

Item	Function	Default setting	Customized setting
Smart entry & start system (→P. 33)	Smart entry & start system	On	Off
	Operation signal (Emergency flashers)	On	Off
Wireless remote control (→P. 47)	Wireless remote control	On	Off
	Unlocking operation	All doors unlocked in one step	Driver's door unlocked in one step, all doors unlocked in two steps
	Time elapsed before automatic door lock function is activated if door is not opened after being unlocked	30 seconds	60 seconds
	120 seconds		

Item	Function	Default setting	Customized setting
Wireless remote control (→P. 47)	Operation signal (Emergency flashers)	On	Off
	Door lock buzzer	On	Off
	Trunk unlocking operation	Push and hold	Push twice
			One short push
Panic function	On	Off	
Door lock (→P. 49, 534)	Speed-detecting automatic door lock function	On	Off
	Opening driver's door unlocks all doors.	Off	On
	Shifting gears to P unlocks all doors.	Off	On
	Shifting gears to position other than P locks all doors.	Off	On
	Unlocking using a key	All doors unlocked in one step	Driver's door unlocked in one step, all doors unlocked in two steps
Trunk (→P. 54)	Power trunk lid function	On	Off

Item	Function	Default setting	Customized setting
Power windows (→P. 89)	Mechanical key linked operation	On	Off
	Mechanical key linked operation	Open and close	Open only
			Close only
	Wireless remote control linked operation	On	Off
	Wireless remote control linked operation	Open and close	Open only
Close only			
Linked entry function	On	Off	
Moon roof (→P. 91)	Mechanical key linked operation	On	Off
	Mechanical key linked operation	Open and close	Open only
			Close only
	Linked operation of components when door key is used	Slide only	Tilt only
	Wireless remote control linked operation	On	Off
	Wireless remote control linked operation	Open and close	Open only
			Close only
Linked operation of components when wireless remote control is used	Slide only	Tilt only	
Linked entry function	On	Off	

Item	Function	Default setting	Customized setting
Automatic light control system (→P. 159)	Light sensor sensitivity	Level 3	Level 1 to 5
Illumination (→P. 377)	Time elapsed before lights turn off	15 seconds	7.5 seconds
			30 seconds
	Operation when the doors are unlocked	On	Off
	Operation after the "ENGINE START STOP" switch is turned OFF	On	Off
	Footwell lighting	On	Off
	Shift lever lighting	On	Off
	Outer foot lights	On	Off

Multi-information display (→P. 155)

Available languages	English, French, German, Spanish and Italian
---------------------	--

Index

Abbreviation list 562

Alphabetical index..... 563

What to do if... 572

Abbreviation/Acronym list

ABBREVIATIONS	MEANING
A/C	Air Conditioning
ABS	Anti-Lock Brake System
AI-SHIFT	Artificial Intelligent Shift control
AFS	Adaptive Front-lighting System
ALR	Automatic Locking Retractor
CRS	Child Restraint System
DISP	Display
ECT	Electronic Controlled Transmission
ECU	Electronic Control Unit
ELR	Emergency Locking Retractor
EPS	Electric Power Steering
INFO	Information
LED	Light Emitting Diode
PWR	Power
SRS	Supplemental Restraint System
TRC	Traction Control
VDIM	Vehicle Dynamics Integrated Management
VGRS	Variable Gear Ratio Steering
VIB	Vibration
VIN	Vehicle Identification Number
VSC	Vehicle Stability Control

Alphabetical index

Alphabetical index

A

A/C

Front air conditioning
system 204, 212

Rear air conditioning
system 221

ABS 182

ACCESSORY mode 135

AFS 160

Adaptive front-lighting system 160

Air conditioning filter 472

Air conditioning system

Air conditioning filter 472

Front air conditioning
system 204, 212

Rear air conditioning
system 221

Airbags

Airbag operating conditions 106

Airbag precautions for your
child 110

Airbag warning light 513

Curtain shield airbag operating
conditions 107

Curtain shield airbag
precautions 110

General airbag precautions 110

Locations of airbags 103

Modification and disposal of
airbags 114

Proper driving posture 101, 110

Side airbag operating
conditions 107

Side airbag precautions 110

SRS airbags 103

Alarm 99

Antenna 237

Anti-lock brake system 182

Armrest 410

Ashtrays 400

Audio input 282

Audio system

Antenna 237

Audio input 282

Audio visual input 331

AUX adapter 282

CD player/changer 238

DVD player 254, 299

MP3/WMA disc 246, 302

Optimal use 278

Portable music player 282

Radio 233, 297

Rear seat audio system 283

Rear seat entertainment
system 289

Steering wheel audio switch 287

Audio visual input 331

Automatic air conditioning system

Front air conditioning
system 204, 212

Rear air conditioning
system 221

Automatic headlight leveling

system 161

Automatic light control system 159

Automatic transmission

Automatic transmission 139

If the shift lever cannot be
shifted from P 530

S mode.....	140
AUX adapter	282

B Back-up lights

Replacing light bulbs.....	493
Wattage.....	554

Battery

Checking	462
If the vehicle has discharged battery	537
Preparing and checking before winter.....	189

Bluetooth®	335
------------------	-----

Brake

Brake Hold	147
Parking brake	144

Brake assist.....	182
-------------------	-----

Brake Hold	147
------------------	-----

C Care

Exterior.....	430
Interior	433
Seat belts.....	434

Cargo hooks.....	425
------------------	-----

CD changer	238
------------------	-----

CD player	238
-----------------	-----

Chains	190
--------------	-----

Child restraint system

Baby seats, definition	115
Baby seats, installation	119
Child seats, definition.....	115
Child seats, installation.....	119
Installing CRS with ISOFIX rigid anchor.....	123
Installing CRS with seatbelts.....	120

Installing CRS with top straps.....	123
Junior seats, definition.....	115
Junior seats, installation	119

Child safety

Airbag precautions	110
Battery precautions.....	464, 539
Child restraint system	115
Child-protectors.....	50
How your child should wear the seatbelt.....	81
Installing child restraints.....	119
Moon roof precautions.....	93
Power window lock switch	89
Power window precautions.....	90
Removed electronic key battery precautions	476
Seat belt comfort guide.....	79
Seat belt precautions.....	82
Seat heater precautions.....	409
Trunk precautions.....	57

Child-protectors.....	50
-----------------------	----

Cigarette lighter	401
-------------------------	-----

Cleaning

Exterior.....	430
Interior.....	433
Seat belts	434

Climate control seat.....	407
---------------------------	-----

Climate control seat filter	474
-----------------------------------	-----

Clock.....	397
------------	-----

Coat hooks.....	423
-----------------	-----

Coin holders.....	384
-------------------	-----

Condenser	462
-----------------	-----

Console box	387
-------------------	-----

Cool box	389
----------------	-----

Cooling system
 Engine overheating541
 Cornering assist sensors171
 Cruise control
 Cruise control167
 Cup holder386
 Curtain shield airbags.....103
 Customizable features556

D

Defogger
 Rear window228
 Side mirrors228
 Dimensions.....546
 Display
 Multi-information display155
 Touch screen196
 Trip information156
 Warning message.....517
 Do-it-yourself maintenance446
 Door courtesy lights
 Door courtesy lights.....377
 Wattage.....554
 Door pockets.....385
 Doors
 Door glasses89
 Door lock.....34, 47, 49
 Side mirrors87
 Driver's seat belt reminder light515
 Driving
 Correct posture101
 Procedures128
 Driving position memory70
 DVD player254, 299

E

Electric power steering182
 Electronic key
 If the electronic key does not
 operate properly.....534
 Emergency, in case of
 If the electronic key does not
 operate properly.....534
 If the engine will not start.....528
 If the parking brake cannot be
 released531
 If the shift lever cannot be
 shifted from P.....530
 If the vehicle has discharged
 battery.....537
 If the warning buzzer sounds.....512
 If the warning light turns on.....512
 If the warning message is
 displayed517
 If you have a flat tire520
 If you lose your keys533
 If you think something is
 wrong.....510
 If your vehicle becomes stuck ...544
 If your vehicle needs to be
 towed.....504
 If your vehicle overheats.....541
 Engine
 Accessory mode135
 Compartment452
 Engine switch136
 Hood449
 How to start the engine135
 Identification number.....547
 Ignition switch135
 If the engine will not start.....528

Overheating.....	541
Engine compartment cover	453
Engine coolant	
Capacity.....	550
Checking	460
Preparing and checking before winter.....	189
Engine coolant temperature	
gauge.....	149
Engine immobilizer system.....	97
Engine oil	
Checking	456
Preparing and checking before winter.....	189
EPS	182
F	
First-aid kit storage belt	426
Floor mat	424
Fluid	
Washer	465
Fog lights	
Replacing light bulbs.....	493
Switch	162
Wattage.....	554
Footwell lighting.....	377
Front fog lights	
Replacing light bulbs.....	493
Switch	162
Wattage.....	554
Front passenger's seat belt	
reminder light.....	515
Front position lights	
Replacing light bulbs.....	493
Switch	159
Wattage.....	554

Front seats	
Adjustment	59
Driver's seat position memory	70
Front turn signal lights	
Wattage	554
Fuel	
Capacity.....	548
Fuel gauge	149
Fuel pump shut off system.....	511
Information.....	555
Refueling.....	94
Fuel door.....	94
Fuel filler door.....	94
Fuel pump shut off system	511
Fuses.....	477
G	
Gauges.....	149
Glove box.....	383
H	
Hands-free system	
(for cellular phone).....	335
Head restraints	
Adjustment	76
Headlight cleaner.....	166
Headlights	
Discharge headlight	
precautions	501
Replacing light bulbs	493
Switch.....	159
Wattage	554
Heaters	
Seat heaters.....	407
Side mirrors.....	228
Hill-start assist control.....	182
Hood.....	449

Hooks	
Cargo.....	425
Coat.....	423
Shopping bag.....	425

I Identification

Engine.....	547
Vehicle.....	547
Ignition switch.....	135
Illuminated entry system.....	377
Indicator lights.....	152
Inside rear view mirror.....	86
Interior lights	
Interior lights.....	377
Switch.....	379
Wattage.....	554

J Jack

Positioning the jack.....	450
Replacing the wheel.....	520
Jack handle.....	520

K Keyless entry..... 47

Keys	
Electronic key.....	28
Engine switch.....	135
If the electronic key does not operate properly.....	534
If you lose your keys.....	533
Keyless entry.....	47
Key number.....	28
Keys.....	28
Mechanical key.....	28
Wireless remote control key.....	47

L Light bulbs

Replacing.....	493
Wattage.....	554

Lights

Door courtesy light.....	377
Fog light switch.....	162
Headlight switch.....	159
Interior light switch.....	379
Outer foot lights.....	377
Overhead courtesy light.....	377
Personal light switch.....	379
Replacing light bulbs.....	493
Shift lever lighting.....	377
Turn signal lever.....	143
Vanity lights.....	396
Wattage.....	554

M Maintenance

Do-it-yourself maintenance.....	446
Maintenance data.....	546
Maintenance requirements.....	436
Maintenance schedule.....	439

Meter

Instrument panel light control.....	150
Meters.....	149

Mirrors

Inside rear view mirror.....	86
Side mirror heaters.....	228
Side mirrors.....	87
Vanity mirrors.....	396

Moon roof..... 91

MP3 disc..... 246, 302

Multi-information display..... 155

O	Odometer.....	149
	Oil	
	Engine oil.....	456
	Opener	
	Fuel filler door.....	94
	Hood.....	449
	Trunk.....	54
	Outer foot lights	
	Outer foot lights.....	377
	Wattage.....	554
	Outside rear view mirrors	
	Adjusting and folding.....	87
	Mirror position memory.....	70
	Outside temperature display	399
	Overhead console.....	393
	Overhead courtesy lights	
	Overhead courtesy lights.....	377
	Wattage.....	554
	Overheating, Engine.....	541
P	Parking assist sensors	171
	Parking brake.....	144
	Penlight.....	521
	Personal lights	
	Switch.....	379
	Pollen removal mode.....	208, 217
	Power outlet.....	403
	Power windows.....	89
R	Radiator.....	462
	Radio.....	233
	Rear fog lights	
	Replacing light bulbs.....	493
	Switch.....	162
	Wattage.....	554

Rear seat	
Seat adjustment.....	63, 66
Seat position memory.....	74
Rear seat entertainment system	289
Rear sunshade.....	415
Rear turn signal lights	
Replacing light bulbs.....	493
Wattage.....	554
Rear view monitor system	179
Rear window defogger	228
Replacing	
Electronic key battery.....	475
Fuses.....	477
Light bulbs.....	493
S	Seat belts
Adjusting the seat belt.....	78
Automatic locking retractor	80
Child restraint system	
installation.....	119
Cleaning and maintaining	
the seat belts.....	434
Emergency Locking Retractor	
(ELR).....	80
How to wear your seat belt.....	78
How your child should wear	
the seat belt.....	81
Pregnant women, proper seat	
belt use.....	80
Reminder light.....	515
Seat belt pretensioners.....	79
Seat heaters.....	409

Seats	
Adjustment.....	59, 63, 66
Adjustment precautions.....	62, 65, 69
Child seats/child restraint system installation	119
Cleaning.....	433
Climate control.....	407
Driver's seat position memory.....	70
Head restraint.....	76
Properly sitting in the seat.....	101
Rear seat position memory.....	74
Rear seat relaxation system.....	411
Seat heaters.....	407
Seat position memory.....	70, 74
Service reminder indicators	152
Shift lever	
Automatic transmission.....	139
If the shift lever cannot be shifted from P	530
Shift lever lighting	377
Shift lock system.....	530
Shopping bag hooks.....	425
Side airbags.....	103
Side mirror	
Adjusting and folding.....	87
Mirror position memory.....	70
Side turn signal lights	
Wattage.....	554
Smart entry & start system	
Entry function.....	33
Starting the engine.....	136
Spare tire	
Inflation pressure.....	553
Spare tire.....	520

Spark plug	550
Specifications	546
Speedometer	
Speed indicator.....	149
Speedometer	149
Steering wheel	
Adjustment	84
Audio switches.....	287
Steering wheel position memory	70
Steering wheel heater	405
Storage feature	381
Stuck vehicle	
If your vehicle becomes stuck ...	544
Sun visors.....	395
Sunshades	
Rear.....	415
Rear door	418
Roof.....	92
Switch	
ECT switch.....	140
Engine switch	135
Fog light switch.....	162
Ignition switch	135
Light switches.....	159
Power door lock switch.....	49
Power trunk lid	54
Power trunk opener and closer...	54
Power window switch.....	89
Window lock switch.....	89
Wiper and washer.....	163

T

Tachometer	
Tacho indicator	149
Tachometer.....	149

Tail lights	
Switch	159
Theft deterrent system	
Alarm	99
Engine immobilizer system.....	97
Tire inflation pressure	469
Tires	
Chains	190
Checking	466
If you have a flat tire.....	520
Inflation pressure.....	469
Replacing.....	520
Rotating tires.....	466
Size.....	553
Snow tires	191
Tools.....	520
Touch screen	196
Towing	
Emergency towing.....	504
Trailer towing.....	192
Traction control.....	182
TRC	182
Trip meter	149
Trunk	
Closer.....	54
Extending a space.....	421
Opener	54
Trunk light	
Wattage.....	554
Turn signal lights	
Replacing light bulbs.....	493
Switch	143
Wattage.....	554

V	Vanity lights	
	Vanity lights.....	396
	Wattage	554
	Vanity mirrors.....	396
	Vehicle identification number.....	547
	Vehicle stability control	182
	VSC	182

W	Warning buzzers	
	Open door	515
	Seat belt reminder	515

Warning lights	
Anti-lock brake system	513
Brake assist system	513
Brake system.....	512, 513
Charging system.....	512
Electric power steering.....	513
Low fuel level.....	515
Malfunction indicator lamp	513
Master warning light.....	515
Open door	515
Pre-crash safety system.....	513
Pretensioners	513
Seat belt reminder light	515
SRS airbags.....	513

Warning messages	
Washer	
Checking.....	465
Preparing and checking	
before winter.....	189
Switch.....	163
Washing and waxing.....	430
Wheels.....	471
Window glasses	89
Window lock switch.....	89

Windows	
Power windows.....	89
Rear window defogger.....	228
Washer.....	163
Windshield wipers.....	163
Windshield wiper de-icer.....	229
Wireless remote control key	
Replacing the battery.....	475
WMA disc.....	246, 302

What to do if... What to do if...

 A tire punctures	P. 520	If you have a flat tire
 The engine does not start	P. 528	If the engine will not start
	P. 97	Engine immobilizer system
	P. 537	If the battery is discharged
 The shift lever cannot be moved out	P. 530	If the shift lever cannot be shifted from P
 The engine coolant temperature gauge enters the red zone	P. 541	If your vehicle overheats
 The key is lost	P. 533	If you lose your keys
 The battery runs out	P. 537	If the battery is discharged
 The doors cannot be locked	P. 49	Doors
 The horn begins to sound	P. 99	Alarm
 The vehicle is stuck in mud or sand	P. 544	If the vehicle becomes stuck



A warning light or indicator light comes on

P. 512

If a warning light turns on



Brake system warning light (red indicator) P. 512



Charging system warning light P. 512



ABS warning light P. 513



Driver's seat belt reminder light P. 515



Brake system warning light (yellow indicator) P. 513



Front passenger's seat belt reminder light P. 515



Low fuel level warning light P. 515



Master warning light with warning message P. 515



SRS warning light P. 513



Electric power steering warning light P. 513



Open door warning light P. 515



Malfunction indicator lamp P. 513

GAS STATION INFORMATION

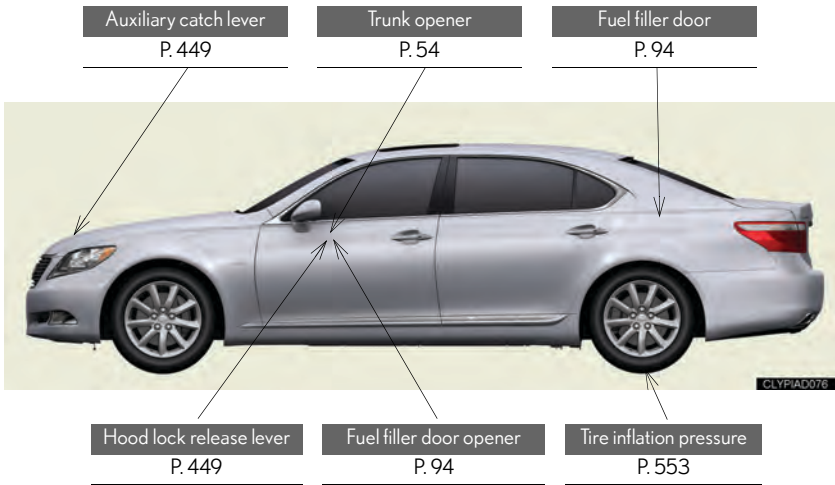

Fuel tank capacity	84L (22.1 gal., 18.4 Imp.gal.)	
Fuel type	Unleaded gasoline only	P. 95, 548
Cold tire inflation pressure		P. 553
Engine oil capacity (Drain and refill)	With filter L (qt., Imp.qt.) 8.6 (9.1, 7.6) Without filter 8.4 (8.9, 7.4)	
Engine oil type	Toyota Genuine Motor Oil or equivalent Oil grade: 20W-50 and 15W-40: API grade SL or SM multigrade engine oil 10W-30, 5W-30, 5W-20 and 0W-20: API grade SL "Energy-Conserving", SM "Energy-Conserving" or ILSAC multigrade engine oil	P. 549



Código: OM993-07BRA-RP
Destino: Brasil
Dezembro/2007